

BUILD VOLTAGE DOUBLERS FOR HIGH-VOLTAGE PROJECTS

Radio Electronics

AUGUST 1991

TECHNOLOGY - VIDEO - STEREO - COMPUTERS - SERVICE

Build this high-performance
SPECTRUM ANALYZER
for a fraction of the cost of commercial units!

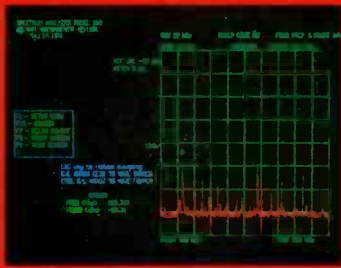

An intuitive look at
ELECTROMAGNETIC THEORY



Build R-E's
ELECTROCARDIOGRAM
to keep tabs on your heart



Use our RS-232
TERMINAL/MONITOR
to solve your serial interfacing problems

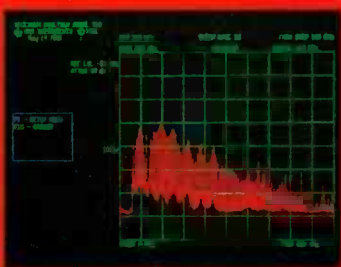

Build an electronic
SPEAKER PROTECTOR
for your stereo system

Understanding and building
VOLTAGE DOUBLERS
for high-voltage applications

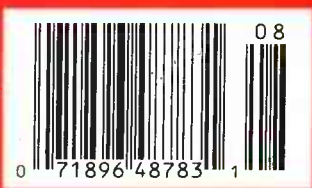

\$2.95 U.S.
\$3.75 CAN



XXXXXXXXXXXXXXXX 5-DIGIT 60506
390736DHMD997G093 08 02
MR ROBERT DAHM JAN 92 RE
997 GRAND AV
AURORA, IL 60506

FLUKE®



PHILIPS



70 SERIES II

8 New Meters. 8 Old-Fashioned Values.

Introducing Fluke's 70 Series II, next-generation multimeters that meet the increasing demands of your job and your budget.

Consider. At the top of the line, the new Fluke 79 and 29 deliver more high-performance features – capacitance, frequency, a fast 63-segment bar graph, Lo-Ohms range, Smoothing™, faster ranges – than DMMs costing much more.

At the entry level, the new model 70, Fluke's lowest-priced DMM ever, delivers unparalleled Fluke quality at a price comparable to "disposable" meters.

And in between are all the models that have made the 70 Series the most popular DMM family in the world – updated, refined and delivering even more value than ever.

"BASICS" REDEFINED

No matter which 70 Series II you choose, you get simple, one-handed operation. High resolution. And built-in, go anywhere reliability.

Automatic Touch Hold® – standard on every model – locks the reading on the display and signals you with a beep, automatically updating for each new measurement without a reset. Leaving you free to concentrate on your work, not on your meter.

YOUR BEST CHOICE

Best of all, every 70 Series II is a Fluke, backed by a worldwide service network and an industry-leading 3 year warranty.

So the next time you're in the market for a new meter, ask for the one that guarantees old-fashioned value. Fluke 70 Series II. For more information call **1-800-6789-LIT**. Or call 1-800-44-FLUKE, ext 33 for the name of your nearest Fluke distributor.

Fluke 79 Series II & 29 Series II

- \$185*
- 4000 Count Digital Display (9999 in Hz & —H—)
- 63 segment Analog Bar Graph
- 0.3% Basic DC Voltage Accuracy
- Automatic Touch Hold®
- Diode Test, Audible Continuity Beeper
- Autorange, Manual Ranging
- Holster with Flex Stand™
- Frequency Counter to over 20 kHz
- Capacitance 10 pF to 9999µF
- Lo-Ohms Range with Zero Calibration
- Smoothing™
- 700 Hours Battery Life (alkaline)
- 3 year Warranty

79/77/75/73/70 for measurements to 4800 V-A.

29/23/21 for higher energy measurements.

*Fluke 70 Series II suggested U.S. list prices range from \$69 to \$185.

John Fluke Mfg. Co., Inc. P.O. Box 9090 M/S 250E Everett, WA 98206 U.S. 206-356-5400
Canada 416-890-7600 Other Countries 206-356-5500 © Copyright 1991 John Fluke Mfg Co., Inc. All rights reserved. Ad no. 00091 Prices and specifications subject to change without notice.

FLUKE®

CIRCLE 121 ON FREE INFORMATION CARD

BUILD THIS

33 LOW-COST SPECTRUM ANALYZER

Our PC-based instrument operates from 0.1–800 MHz, and costs about \$300.

Dan Doberstein and John Cardone

44 ELECTROCARDIOGRAPH

Learn about medical electronics while monitoring your heart.

H. Edward Roberts, M.D.

50 RS-232 TERMINAL/MONITOR

This device can act as a dumb terminal or as a sophisticated serial bus analyzer.

Steven Avritch

55 BUILD A SPEAKER PROTECTOR

Protect your speakers in the event of an amplifier failure.

Mark A. Vaught

TECHNOLOGY

61 VOLTAGE DOUBLERS

An inexpensive, easy way to experiment with high voltage.

Ralph Hubscher

65 AN INTUITIVE LOOK AT ELECTROMAGNETIC THEORY

An in-depth look at the electric field.

William P. Rice

DEPARTMENTS

6 VIDEO NEWS

What's new in this fast-changing field.

David Lachenbruch

22 EQUIPMENT REPORTS

Sharp PC-3500 Pocket Computer.

69 HARDWARE HACKER

Caller identification, and more.

Don Lancaster

77 DRAWING BOARD

A PC board for our audible logic probe.

Robert Grossblatt

80 AUDIO UPDATE

Audio tapes: past, present, and future.

Larry Klein

80 COMPUTER CONNECTIONS

The friendly Amiga.

Jeff Holtzman



This simple circuit will protect your stereo speakers in the event of amplifier failure.

MARK A. VAUGHT
The speaker protector circuit is a simple and effective way to protect your speakers from amplifier failure. It consists of a diode and a resistor connected in series with the speaker terminals. When the amplifier output goes into clipping, the diode conducts and limits the voltage across the speaker. This prevents the speaker from being driven into thermal or mechanical failure. The circuit is easy to build and costs very little.

PAGE 55



Voltage doublers are an easy and inexpensive way to experiment with high voltage.

RALPH HUBSCHER
Voltage doublers are a simple and effective way to generate high voltages for experimentation. They consist of two capacitors and two diodes connected in a specific configuration. The first capacitor is charged by the AC input, and the second capacitor is charged by the first capacitor. The output voltage is the sum of the two capacitor voltages. This circuit is easy to build and costs very little.

PAGE 61

AND MORE

96 Advertising and Sales Offices

96 Advertising Index

8 Ask R-E

14 Letters

84 Market Center

31 New Lit

24 New Products

4 What's News

ON THE COVER



For examining the components of a signal spectrum, you can't beat the versatility and convenience of a spectrum analyzer. It allows you to measure parameters such as power, frequency response, harmonic distortion, and the amplitudes of complex components. All those functions don't come cheap, however—unless you build our PC-based analyzer, which costs about \$300. Consisting of a single printed-circuit board, the spectrum analyzer requires a modestly configured PC to act as the host machine and display. The calibrated 0.1 ± 810 -MHz analyzer provides repeatable, accurate measurements of frequency and power, and includes an array of special features. To get started, turn to page 33.

COMING NEXT MONTH

THE SEPTEMBER ISSUE GOES ON SALE AUGUST 6.

BUILD A MULTIMEDIA PC-TO-TV CONVERTER

Put computer power to work in your home videos.

BUILD THE MICROANALYZER

For servicing microwave ovens, this handy tool will test in-circuit, high-voltage diodes, capacitors, magnetrons, and power transformers.

BUILD A TELEPHONE LINE SENTRY

Protect against losing that modem connection and other phone-line annoyances.

AN INTUITIVE LOOK AT ELECTROMAGNETIC THEORY

In Part II, we look at electric phenomena.

As a service to readers, RADIO-ELECTRONICS publishes available plans or information relating to newsworthy products, techniques and scientific and technological developments. Because of possible variances in the quality and condition of materials and workmanship used by readers, RADIO-ELECTRONICS disclaims any responsibility for the safe and proper functioning of reader-built projects based upon or from plans or information published in this magazine.

Since some of the equipment and circuitry described in RADIO-ELECTRONICS may relate to or be covered by U.S. patents, RADIO-ELECTRONICS disclaims any liability for the infringement of such patents by the making, using, or selling of any such equipment or circuitry, and suggests that anyone interested in such projects consult a patent attorney.

RADIO-ELECTRONICS, (ISSN 0033-7862) August 1991. Published monthly by Gernsback Publications, Inc., 500-B Bi-County Boulevard, Farmingdale, NY 11735 Second-Class Postage paid at Farmingdale, NY and additional mailing offices. Second-Class mail registration No. R125166280, authorized at Toronto, Canada. One-year subscription rate U.S.A. and possessions \$17.97, Canada \$25.65 (includes G.S.T. Canadian Goods and Services Tax Registration No. R125166280), all other countries \$26.97. All subscription orders payable in U.S.A. funds only, via international postal money order or check drawn on a U.S.A. bank. Single copies \$2.95. © 1991 by Gernsback Publications, Inc. All rights reserved. Printed in U.S.A.

POSTMASTER: Please send address changes to RADIO-ELECTRONICS, Subscription Dept., Box 55115, Boulder, CO 80321-5115.

A stamped self-addressed envelope must accompany all submitted manuscripts and/or artwork or photographs if their return is desired should they be rejected. We disclaim any responsibility for the loss or damage of manuscripts and/or artwork or photographs while in our possession or otherwise.

Radio Electronics®

Hugo Gernsback (1884-1967) founder

Larry Steckler, EHF, CET,
editor-in-chief and publisher

EDITORIAL DEPARTMENT

Brian C. Fenton, editor

Marc Spiwak, associate editor

Kim Dunleavy,
assistant technical editor

Teri Scaduto, assistant editor

Jeffrey K. Holtzman
computer editor

Robert Grossblatt, circuits editor

Larry Klein, audio editor

David Lachenbruch
contributing editor

Don Lancaster
contributing editor

Kathy Terenzi, editorial assistant

ART DEPARTMENT

Andre Duzant, art director

Injae Lee, illustrator

Russell C. Truelson, illustrator

PRODUCTION DEPARTMENT

Ruby M. Yee, production director

Janice Box,
editorial production

Karen S. Brown
advertising production

Marcella Amoroso
production assistant

CIRCULATION DEPARTMENT

Jacqueline P. Cheeseboro
circulation director

Wendy Alanko
circulation analyst

Theresa Lombardo
circulation assistant

Michele Torrillo, reprint bookstore

Typography by Mates Graphics

Cover photo by Diversified Photo
Services

Radio-Electronics is indexed in
Applied Science & Technology Index
and *Readers Guide to Periodical Literature*.

Microfilm & Microfiche editions are
available. Contact circulation department
for details.

**Advertising Sales Offices listed
on page 94.**

Radio-Electronics Executive and
Administrative Offices
1-516-293-3000.

Subscriber Customer Service:
1-800-288-0652.

Order Entry for New Subscribers:
1-800-999-7139.



The
Audit
Bureau
of Circulation



5 WAYS TO STOP WASTING TIME IN ELECTRONICS.

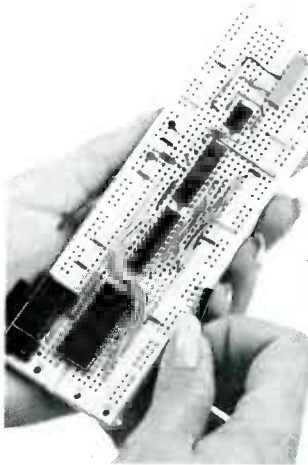

Stop wasting your time soldering. Save hours of soldering, desoldering, resoldering with Quick Test™ sockets and bus strips. Connect/disconnect resistors, capacitors, transistors, ICs, etc. as fast as you can push in/pull out leads. Interlock for limitless expandability. Priced as low as \$1.60, you'll wonder how you've done without them!

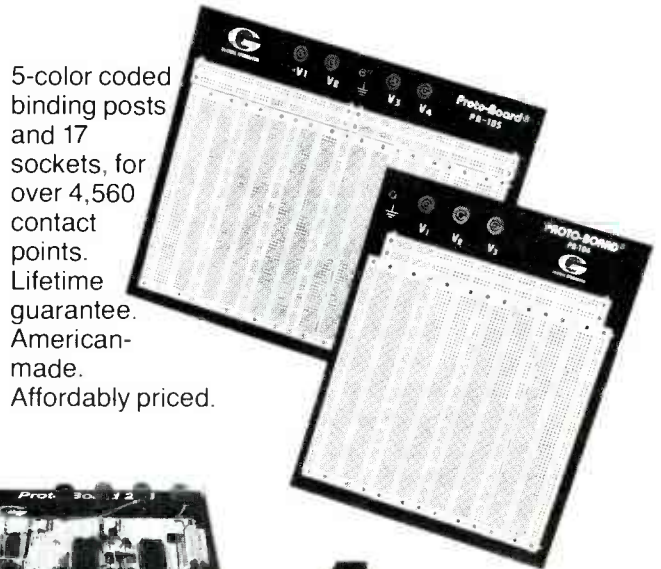

5-color coded binding posts and 17 sockets, for over 4,560 contact points. Lifetime guarantee. American-made. Affordably priced.

2. Stop wasting your time breadboarding.

Here are three popular PROTO BOARD® Brand solderless breadboarding systems that meet any budget or time schedule. First the diminutive PB-10's 840 contact points and 3-color binding posts. PB-102 has 1,240 tie points, accepting up to 12 16-pin ICs. Finally, PB-103, with 2,250 contact points, and up to 24 16-pin capacity. They're affordable, American-made, lifetime guaranteed. You'll soon see why PROTO BOARD Brand is Today's Standard for Quality in Breadboarding.



3. Stop wasting your time jury-rigging

large numbers of circuits. Here are two oversized PROTO BOARDS Brand, with expanded area, tie points, and more to keep your ideas together. PB-104 features 3,060 tie points, which can handle to 32 16-pin ICs with ease. Four color coded binding posts, and roomy 9.2" x 8" metal panel make it big...but simple. The humungous PB-105 lets you load up to 48 16-pin ICs, and much more onto its

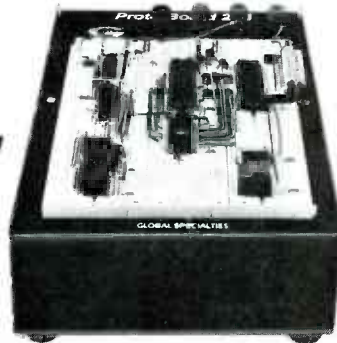

4. Stop wasting your time plugging-in external power.

We've added the power to the breadboard. And, what power! Up to triple voltage power, +5V, +12V, -12V, regulated/current limited and DC. Up to 2,250 tie points, with 24 IC capacity and 14 pin DIPs. Now you can create, test and modify TTL, CMOS,

Op-Amps and even microprocessor circuits. Plus, there is the standard Global Lifetime Guarantee on the sockets. And, wait 'til you see the modest prices!

5. NEW!

Stop wasting time designing computer circuits. Now you can use your solderless breadboard concepts for designing accessory circuits. PROTOCARD® is a PROTO BOARD Brand which fits any standard slot in your IBM, PC/XT or PC/AT computer. Some modules even include built-in basic decoder circuits for memory and I/O addressing. Breadboard areas up to 3,360 contact points. Buffered versions eliminate loading of pc buses.

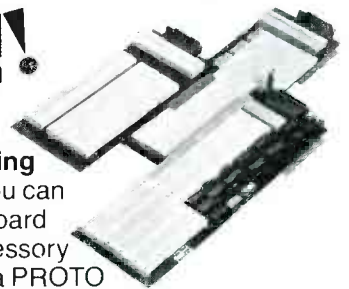

Call toll-free for details
1-800-572-1028

GLOBAL SPECIALTIES

Global Specialties. An Interplex Electronics Company.
70 Fulton Terrace. New Haven, CT 06512
Telephone: (203) 624-3103. © Interplex Electronics 1989.
All Global Specialties breadboarding products made in USA

CIRCLE 190 ON FREE INFORMATION CARD

www.americanradiohistory.com

Easy does it!™

WHAT'S NEWS

A review of the latest happenings in electronics.

Superconducting transistor used in electronic circuits

Made from the new high-temperature superconducting materials, a superconducting transistor developed jointly by scientists at Sandia National Laboratories (Albuquerque, NM) and the University of Wisconsin, Madison, has been used in functioning electronic circuits. Dubbed the Superconducting Flux Flow Transistor (SFFT), the device can be considered the superconducting analogue to the field effect transistor (FET), the "workhorse" semiconductor that is in wide use worldwide. A transistor is an "active device"—one that can produce a power gain—and the SFFT is the first transistor made entirely from high-temperature superconducting materials. Circuits incorporating the device can operate above 77 K, the temperature of liquid nitrogen, a widely available and inexpensive coolant.

The SFFT consists of parallel, weak superconducting links that separate two pieces of semiconductor and a control line to provide a local magnetic field. While a FET's output current is controlled by changing the input voltage, the SFFT's output voltage is controlled by changing the in-

put current. Acting like a gate, the current in the control line alters the magnetic field in the active region of the device, which modulates the output voltage and can provide gain at very high (microwave) frequencies.

The team of scientists took the device and coupled it with passive microwave components in real circuits that represent the essential components of electronic communications and signal processing technology, including amplifiers, oscillators, phase shifters, and mixers. Microwave amplifiers built with the SFFT show a gain of 10 dB at 4 GHz. The SFFT has also been used to make mixers—devices that mix together two frequencies to produce a different output frequency—that operate at up to 35 GHz.

The SFFT can serve as an interface between conventional, low-temperature superconducting electronics and semiconductor electronics. The SFFT has a low input resistance and a reasonably high output resistance, which allows it to serve as an active link between superconducting and semiconductor circuits. In Sandia's experiments, a Josephson junction drives the input of an SFFT, which then drives the gate of a field effect

transistor. Current research concentrates on developing a technology around the SFFT that includes passive and active components in a whole family of applications.

CEBus developments

CEBus, the home-automation standard being developed by the Electronic Industries Association/Consumer Electronics Group (EIA/CEG), allows communication throughout the home between a variety of electronic products over existing power lines, twisted pairs (telephone), coaxial cable, and infrared means. The infrared and twisted pair sections of the CEBus (Consumer Electronics Bus) standard have been approved as interim standards. The new interim infrared standard covers the transmission of signal to integrated CEBus products—for example, the interfacing of security devices with telephone equipment—while twisted pair standard facilitates flexible room-to-room communication. The interim standards are considered by the EIA/CEG to be a major milestone on the road to a complete, overall standard, which is expected to be announced by the end of this year.

The first public working display of CEBus technology is the Bright Home, in Indianapolis, which opened at the end of March for a six month period of public tours. The Bright Home links a variety of electronic equipment and appliances into a common intelligent-control system.

The Bright Home display is intended to demonstrate the "building-block" approach to CEBus technology, which allows consumers to integrate as many CEBus products into their new or remodeled homes that their budgets and needs dictate. Among the various companies contributing products to the Bright Home project are Panasonic, Sony, and Thomson/RCA; the CEBus products and technology are provided by Hometronics, an integrated electronics consultant that's located in Indianapolis.

R-E

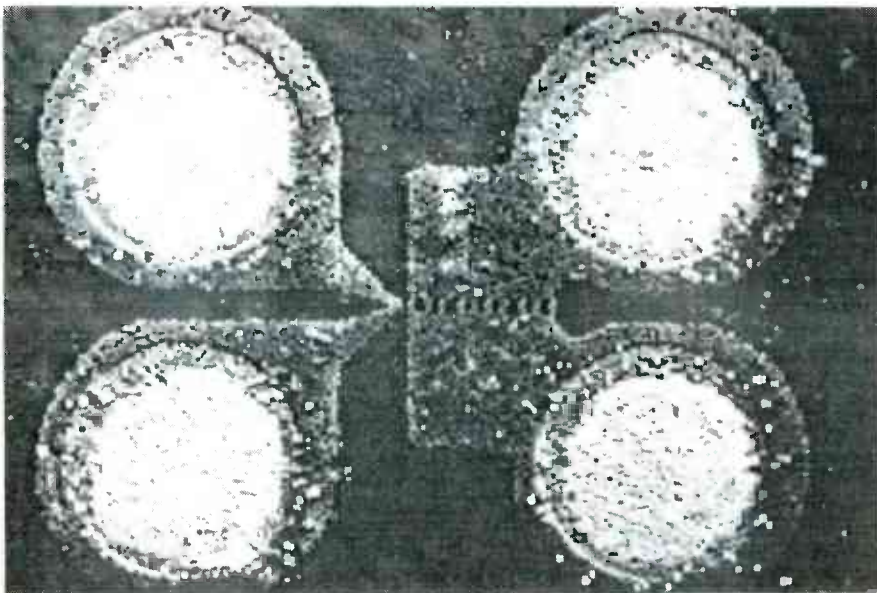

THIS PHOTOMICROGRAPH of a superconducting flux flow transistor (SFFT) shows the source (upper right), drain (lower right), and the control line (left).

RADIO SHACK

PARTS PLACESM

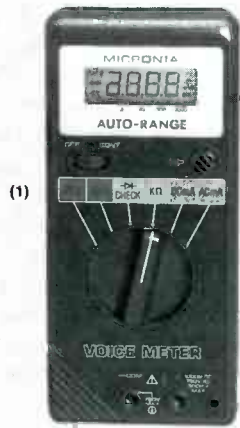

(1)

(1) **Talking Multimeter.** Timesaving *speech* output! Press a button on the probe and this meter calls out the reading in clear English while displaying it. Features include full autoranging, liquid crystal display with low-battery and over-range indicators, continuity beeper, diode-check mode. #22-164 99.95

(2) **NEW! Building Power Supplies.** Easy-to-understand, 96-page book explains linear and switching supplies. Includes complete plans for building five useful supplies with Radio Shack parts. #276-5025, 4.95

(3) **Mini Audio Amplifier.** Great for computer voice/music synthesis, signal tracing and more. Has a built-in speaker, 1/8" headphone jack, 1/8" input jack and volume control. #277-1008 11.95

(4) **Digital Logic Probe.** LEDs and tone outputs reveal logic states instantly. It's the fast way to check operation and pinpoint problems in all types of digital circuits. #22-303 16.95

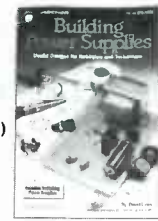

(2)



(3)



(4)

Parts Special-Order Hotline. Your local Radio Shack store stocks over 1000 popular electronic components. Plus, we can special-order over 10,000 items from our warehouse—linear and digital ICs, transistors and diodes, vacuum tubes, crystals, phono cartridges and styli, even SAMS® service manuals. Your order is sent directly to your Radio Shack store and we notify you when it arrives. Delivery time for most items is one week and there are no postage charges or minimum order requirements.

(1) **Shielded RS-232 Jumper Box.** Top-quality inline D-sub 25 adapter. Wire the included jumper wires and board to suit your need. #276-1403 9.95

(2) **RS-232 Tester.** Dual-color LEDs monitor seven data/control lines to help you spot problems quickly. D-sub 25. Connects inline. #276-1401 14.95

(3) **Grounded-Tip Soldering Iron.** 15W. #64-2051 7.49

(4) **Vacuum-Type Desoldering Tool.** #64-2120 6.95

(5) **Locking Forceps.** 6" long. Stainless. #64-1866 4.95

(6) **Rosin Soldering Paste Flux.** #64-021 1.79

(7) **Lead-Free Solder.** 0.25 oz. #64-025 1.99

Over 100 soldering items and tools for electronics work are in stock at Radio Shack!

(8) **10A Microwave Oven Fuses.** #270-1256 Pkg. of 2/1.29

(9) **2-Amp Fast-Acting Fuses.** #270-1275 Pkg. of 3/1.79

(10) **5-Amp "Blade" Car Fuses.** #270-1205 Pkg. of 2/89¢

Big selection of fuses, holders and accessories in stock!

Computer/Business Machine AC Power Cords. 6 feet long.

(11) **Extension.** #278-1259 4.99

(12) **With Space-Saving 90° CEE Connector.** #278-1260 5.99

(13) **With Straight CEE Connector.** #278-1257 3.99



(1)

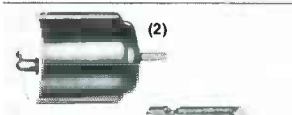

(2)



(3)

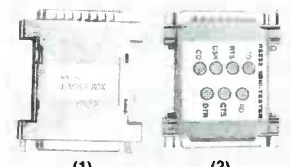

(1)

(2)

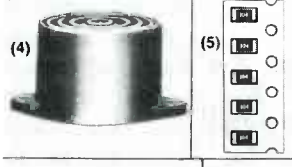

(4)

(5)

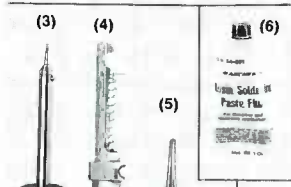

(3)

(4)

(5)

(6)



(6)



(7)



(8)



(9)



(10)



(11)



(12)



(13)

(14)

(15)

(1) **Voltage Regulator ICs.** Feature built-in overload protection and thermal shutdown. Maximum input: 35VDC.

7805. 5V. #276-1770 1.19
7812. 12V. #276-1771 1.19

(2) **Low-Voltage Motor.** Just the thing for science projects, robotics and solar power demos. Operates 1 1/2 to 3VDC. About 1 1/2" long. #273-223 99¢

(3) **High-Speed 12VDC Motor.** Up to 15,200 RPM, no load. About 2" long. #273-255 2.99

(4) **"Ding-Dong" Chime.** This IC and mini-speaker combo is ideal for a customer-entry alert or doorbell. Produces 80 dB sound pressure at 12 VDC. Operates 6 to 18 VDC. #273-071 8.99

(5) **Surface-Mount Resistors.** 200-piece assortment of 15 popular values. Rated 1/8 watt, 5%. #271-313 Set 4.99

Radio Shack Has 20 different project enclosures in stock!

(6) **Metal Project Cabinet.** An attractive, easy-to-drill housing at a low price. 3 x 5 1/4 x 5 7/8". #270-253 6.79

(7) **Project Labels.** Four sheets of rub-on letters, numerals and calibrations. #270-201 2.99

(8) **Power Supply Case.** Vented 2 1/2 x 4 5/8 x 3 1/4" molded case. #270-287 3.99

(9) **0 to 15 DC Voltmeter.** Panel-mount. #270-1754 7.95

(10) **Box/Board Combo.** Molded enclosure plus predrilled 2 x 3 1/8" board, labels and more. #270-291 4.99

(11) **Eight-Position Phono Jack Board.** #274-370 1.39

(12) **1:1 Audio Transformer.** Z: 600-900Ω. #273-1374 3.59

(13) **Three-Pin XLR Mike Plug.** Metal body. #274-010 2.99

(14) **Three-Pin XLR Mike Inline Socket.** #274-011 2.99

(15) **Three-Pin XLR Mike Panel Socket.** #274-013 3.69

Since 1921 Radio Shack has been the place to obtain up-to-date electronic parts as well as quality tools, test equipment and accessories at low prices. Over 7000 locations to serve you—NOBODY COMPARES

Prices apply at participating Radio Shack stores and dealers. Radio Shack is a division of Tandy Corporation

CIRCLE 78 ON FREE INFORMATION CARD

Radio Shack
AMERICA'S TECHNOLOGY STORE

VIDEO NEWS

What's new in the fast-changing video industry.

DAVID LACHENBRUCH

• Multimedia expands.

Following the introduction of CDTV by Commodore (**Radio-Electronics**, July 1991), several manufacturers are poised to introduce the standardized CD-I (Compact Disc-Interactive) system this fall. Philips has announced that it will field Magnavox brand players in the U.S. in October, followed by a Philips brand unit a month later, and Sony, Panasonic, and others have indicated that they'll be in the market this year.

The Magnavox CD-I players will carry a suggested list price of \$1,400, but are expected to sell at about \$1,000. They'll play standard CD audio discs, CD + Graphics (CD + G) discs, and the forthcoming Photo CD discs as well as multimedia CD-I discs. Discs will sell for around \$20 to \$60. Although initial discs will have animation at 15 frames per second, true full-motion video won't be available until some time in 1992. At that time, a simple plug-in adaptor (containing an MPU chip) will be offered to update players, but the original software will still be playable. When full-motion, full-screen video finally is available, the five-inch CD-I disc may well replace the 12-inch laserdisc as the preferred carrier for recorded movies.

The jury is still out on the various CD-ROM multimedia products—at least with regard to the extravagant claims that they constitute the next hot consumer-electronics product or the successor to print publishing.

• **Closed captions.** The FCC has accepted industry recommendations to implement the closed caption law with a relatively simple method of achieving captioning for the hearing impaired. Congress passed a law requiring caption reception capability in all sets 13 inches and larger manufactured or imported after June 30, 1993 (**Radio-Electronics**, May, 1991). An EIA task force recommended a system that uses on-screen graphics capabilities already employed by many TV set manufacturers. Some features that are now mandatory in

the captioning rules will be made optional, and other features will be added. Zenith has indicated that it will introduce closed-caption receivers well in advance of the deadline, with the first sets to appear this year at moderate prices, starting at around the \$299 area. The captions, when generally adopted by the industry, are expected to be useful in areas other than assisting hard-of-hearing consumers, and could even lead to some kind of program identification system—such as display of the name of the program or episode—or even a possible automatic system that would permit viewers to program their VCR's by the name of the program to be recorded.

• **Widescreen VHS.** JVC and Thomson Consumer Electronics (whose U.S. brands are RCA and GE) are working together on a compatible system to record widescreen 16:9 images on standard VHS video recorders. According to JVC, the system would involve "identification signals" for automatic switching between 16:9 and standard 4:3 aspect ratios. The system presumably would be a version of Super VHS recording. In Europe, widescreen enhanced-definition programming is already being transmitted by satellite, and in the U.S. Thomson and Philips are pushing ACTV, an enhanced widescreen system, as an intermediate step before HDTV. Thomson and Philips are consulting with other manufacturers on the proposed parameters, and JVC says it hopes to commercialize the system within a year.

• **Video compression.** All of a sudden, everybody's talking about compression technology. From satellites to multimedia to HDTV, bandwidth compression is now regarded as the biggest breakthrough since color TV. A cable system in Queens, N.Y. is now planning to offer 150 channels through a combination of compression and optical fiber. HBO will soon be offering a three-channel service to cable systems which can

take advantage of compression to let viewers choose the starting time of the movies they want to watch. Sky-pix pay-TV service is squashing six channels into one on a satellite transponder. Multimedia services, such as CD-I, are now talking about full-motion video on 5-inch optical discs through the use of compression. The computer has changed the nature of television. Soon there will no longer be a scarcity of spectrum because of the ability to squeeze many channels into one.

• **Big-screen sets gain.** In spite of an 8% decline in total sales of color TV sets in the first three months of 1991 (as compared with the same period in 1990), direct-view sets 27 inches and up rose by 13%, and projection set sales were up 15%—indicating a growing move to larger sets. Sets 27 inches and larger, including projection, rose to 16.8% of total sales from 12.2% in the similar year-earlier period. Direct-view sets with sizes 30 inches and larger jumped by 43.6%.

• VCR popularity contest.

What's the biggest-selling brand of camcorder? Why Sony, by a large margin. The latest survey by *Television Digest* newsletter gives Sony an 18% share of the camcorder market, followed by Panasonic with 14%, RCA with 13%, and Sears and JVC with 7.5% each. Runners-up to that top five were Sharp, Magnavox, GE, Hitachi, and Canon, in that order. The same survey which produced those rankings showed manufacturers think 8mm will be 1991's leading format, accounting for 44% of camcorder sales, followed by full-size VHS with 40%, and VHS-C with 16%.

In video decks, RCA was the undisputed leader with 11% of the market, with Panasonic second at 8%, Emerson, Sharp and Magnavox 7% each, followed by JVC, Zenith, Sears, and Goldstar. The survey reflects shares and rankings for the full-year of 1990.

R-E

48 HOUR SHIPPING

ELENCO & HITACHI PRODUCTS AT DISCOUNT PRICES

48 HOUR SHIPPING

Hitachi RSO Series

(Portable Real-time Digital Storage Oscilloscopes)
 VC-6023 - 20MHz, 20MS/s _____ \$99/mo*
 VC-6024 - 50MHz, 20MS/s _____ \$120/mo*
 VC-6025 - 50MHz, 20MS/s _____ \$135/mo*
 VC-6045 - 100MHz, 40MS/s _____ \$125/mo*
 VC-6145 - 100MHz, 100MS/s _____ \$200/mo*

RSOs from Hitachi feature roll mode, averaging, save memory, smoothing, interpolation, pretriggering, cursor measurements. These scopes enable more accurate, simpler observation of complex waveforms, in addition to such functions as hardcopy via a plotter interface and waveform transfer via the RS-232C interface. Enjoy the comfort of analog and the power to digital.

20MHz Elenco Oscilloscope

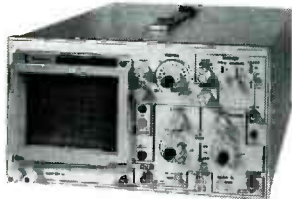

\$375
MO-1251
 • Dual Trace Component Tester
 • 6" CRT
 • X-Y Operation
 • TV Sync
 • 2 P-1 Probes

LEASING AVAILABLE

For all Hitachi Scopes - Call for details

* Based on 24 months except V-1150, VC 6045, VC-6145 (36 months)

Hitachi Portable Scopes

DC to 50MHz, 2-Channel, DC offset function, Alternate magnifier function

V-525 - CRT Readout, Cursor Meas. _____ \$1,025
 V-523 - Delayed Sweep _____ \$995
 V-522 - Basic Model _____ \$895
 V-422 - 40MHz _____ \$795
 V-223 - 20MHz delayed sweep _____ \$695
 V-212 - 20MHz _____ \$425

HITACHI COMPACT SERIES SCOPES

This series provides many new functions such as CRT Readout, Cursor measurements (V-1085/1065/665), Frequency Ctr (V-1085), Sweeptime Autoranging, Delayed sweep and Tripper Lock using a 6-inch CRT. You don't feel the compactness in terms of performance and operation.

V-660 - 60MHz, Dual Trace _____ \$1,195
 V-665 - 60MHz, DT, w/cursor _____ \$1,345
 V-1060 - 100MHz, Dual Trace _____ \$1,425
 V-1065 - 100MHz, DT, w/cursor _____ \$105/mo*
 V-1085 - 100MHz, QT, w/cursor _____ \$125/mo*
 V-1100A - 100MHz, Quad Trace _____ \$125/mo*
 V-1150 - 150MHz, Quad Trace _____ \$115/mo*

Elenco 35MHz Dual Trace

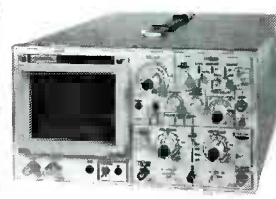

Good to **\$495**
50MHz MO-1252
 • High luminance 6" CRT
 • 1mV Sensitivity
 • 6KV Acceleration Voltage
 • 10ns Rise Time
 • X-Y Operation • Z Axis
 • Delayed Triggering Sweep
 • Includes 2 P-1 Probes

FREE DMM
 with purchase of
ANY SCOPE
SCOPE PROBES
 P-1 65MHz, 1x, 10x \$19.95
 P-2 100MHz, 1x, 10x \$23.95

All scopes include probes, schematics, operators manual and 3 year (2 yrs for Elenco scopes) world wide warranty on parts & labor. Many accessories available for all Hitachi scopes. Call or write for complete specifications on these and many other fine oscilloscopes.

Beckman TEST EQUIPMENT

All Models Available

Call for special price

Digital Capacitance Meter



CM-1550B
\$58.95
 9 Ranges
 1pt-20,000ufd
 .5% basic accy.
 Zero control w/ Case
 Big 1" Display

Digital LCR Meter



LC-1801
\$125
 Measures:
 Coils 1uH-200H
 Caps .1pf-200uf
 Res .01-20M



Multimeter with Capacitance & Transistor Tester
\$55 CM-1500B
 Reads Volts, Ohms
 Current, Capacitors,
 Transistors and
 Diodes / with case

FLUKE MULTIMETERS

All Models Available

Call for special price

Quad Power Supply XP-580



\$59.95
 2-20V @ 2A
 12V @ 1A
 5V @ 3A
 -5V @ .5A

Fully regulated and short circuit protected

Triple Power Supply XP-620



Assembled \$65
 Kit \$45
 2 to 15V @ 1A,
 -2 to -15V @ 1A
 (or 4 to 30V @ 1A)
 and 5V @ 3A

All the desired features for doing experiments.
 Features short circuit protection, all supplies

AM/FM Transistor Radio Kit with Training Course

Model AM/FM 108
\$26.95

14 Transistors • 5 Diodes
 Makes a great school project

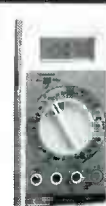

True RMS 4 1/2
 Digit Multimeter
M-7000
\$135
 .05% DC Accuracy
 .1% Resistance
 with Freq. Counter
 and Deluxe Case

GF-8016 Function Generator with Freq. Counter



\$249

Sine, Square, Triangle
 Pulse, Ramp, .2 to 2MHz
 Freq Counter .1 - 10MHz

GF-8015 without Freq. Meter \$179

Function Generator Blox



#9600
\$28.95

Provides sine, triangle, square
 wave from 1Hz to 1MHz
 AM or FM capability

Learn to Build and Program Computers with this Kit

Includes: All Parts, Assembly and Lesson Manual



Model
MM-8000
\$129.00

Starting from scratch you build a complete system. Our Micro-Master trainer teaches you to write into RAMs, ROMs and run a 8085 microprocessor, which uses similar machine language as IBM PC.

Robotics Kit for above (MM8010) 71.95

Wide Band Signal Generators



SG-9000 \$129
 RF Freq 100K-450MHz AM Modulation of 1KHz Variable RF output
 SG-9500 w/ Digital Display & 150MHz built-in Counter \$249

MOVIT EDUCATIONAL ELECTRONIC ROBOT KITS

The MOVIT line is a series of computerized (and logic controlled) battery robot kits that can teach the basic principles of robotic sensing and locomotion. Each of the kits features pre-assembled PC boards, hardware and mechanical-drive systems that can be handled by almost anyone from ages 10 and up. Only basic hand tools are required for assembly. These fascinating robots allow you to experience and learn any one of the following features: sound sensor, remote control, infra-red sensor, wired control and / or programmable memory. The MOVIT line has provided the future with an innovative electronic educational kit. They are affordable robots that can entertain as well as educate. Now meet the family!



| | | | |
|----------------------------------|---------|-------------------------------------|---------|
| MV-912 Avider Infra-red | \$45.95 | MV-939 Medusa Sound Sensor | \$29.95 |
| MV-915 Piper mouse Sound Sensor | \$45.95 | MV-963 Line Tracker Infra-red | \$45.95 |
| MV-916 Peppy Sound Touch | \$25.95 | MV-966 Manta Sound/Touch | \$29.95 |
| MV-931 Mr. Bootsman Wire Control | \$35.95 | Y-01 Robotic Arm Robotic Control | \$45.95 |
| MV-932 Catrat Remote Control | \$45.95 | BT-802 Grand Piano Electronic Piano | \$29.95 |
| MV-936 S-Cargo Sound Sensor | \$45.95 | BT-805 Roulette Digital Wheel | \$35.95 |

WE WILL NOT BE UNDERSOLD!

UPS Shipping: 48 States 5%
 (\$3 Min \$10 Max) Shipping
 IL Res., 7% Tax FAX: 708-520-0085

C & S SALES INC.
 1245 Rosewood, Deerfield, IL 60015
 (800) 292-7711 (708) 541-0710



15 Day Money Back Guarantee
2 Year Warranty Prices Subject to Change
WRITE FOR FREE CATALOG

CIRCLE 109 ON FREE INFORMATION CARD

ASK R-E

Write to Ask R-E, Radio-Electronics, 500-B Bi-County Blvd., Farmingdale, NY 11735

SINGLE-CHANNEL FILTER

Is it possible to buy a filter that would attenuate only one station (channel 58), by about 6 dB? The channel is causing ghosting on neighboring channel 56. I live in a fringe area and channel 58 is many miles closer than channel 56. I have several TV sets and only my new Heathkit TV is suffering from this problem.—R. Law, Wellfleet, MA

I've never had a problem like this so I can't give you a ready-to-wear answer to the problem. There are some things about your predicament that surprise me however, and I have a few suggestions about what you can do.

The first thing that struck me is that you're getting channel crosstalk and interference on only one TV—and a new one at that. If this had been a problem on every TV in your house I would have called it an unavoidable problem but, since it happens on only one TV, it's logical to suspect the tuner in that TV.

I called Heathkit to ask them about your problem and everyone that I spoke to went on at length about the quality of their tuners and was surprised that you were having that problem. You didn't include signal-strength readings with your letter—if you have such readings you can contact Heathkit again and they'll tell you whether the tuner in your TV is performing up to spec.

If you don't want to do that, or if you don't have any access to a signal-strength meter, you can accept the crosstalk as a feature (?) of your TV and, as you asked in your letter, do something to attenuate the channel-58 signal before it gets to your TV.

There are several companies around that specialize in making traps to remove either individual channels or a range of channels and you'll find that a bunch of them advertise in **Radio-Electronics**. I called Star Circuits of Las Vegas (1-800-433-6319), a **Radio-Electronics** advertiser who makes channel traps. The people there were extremely helpful and, when I explained the problem, they

were sure they could come up with something that would do the job.

They sell their traps for about twenty five bucks and, even though I still think the problem is in your TV's tuner, it's probably a lot less of a hassle to add an attenuator to the antenna input than it is to start fooling around with the circuitry in your TV.

MOTORCYCLE REBUILD

I'm rebuilding a 1970's era motorcycle and am stuck on how to go about setting up a power-management system. I have an alternator and am now looking for a voltage regulator. In the best of all possible worlds I would have a redundant system so that if one fails I could switch over to the other one. Can you help?—G. Perry, Barrington, NH

Every once in while a letter comes in that I can take a particular pleasure in answering. You couldn't have sent your letter to a better person—I own a 1968 Jaguar and recently finished rebuilding a 1968 Triumph Bonneville. For my money, that's the best bike ever made.

I had a similar problem to yours when it came to the electrical system. All the original stuff was made by Lucas (why do the British drink warm beer?—because they use Lucas refrigerators), and I had no desire to use the original parts. And when I found out that the original Lucas reg-

ulator cost eighty-five bucks, I was doubly sure I wanted to do something of my own. After all, a voltage regulator is an electronic thing and I know about that stuff.

The circuit shown in Fig. 1 is the voltage regulator I've been using in both my car and the bike. It's been working in my car for about eight years and I've never had any trouble with it. As you can see, it uses standard parts that can be gotten almost anywhere.

Before you go out and get everything you need to build the circuit there are some things you have to know about an alternator. Different bike and car manufacturers use different techniques to handle all the alternator connections and you have to know how your bike is set up before you get started. Since you're rebuilding everything anyway, it may be possible to set things up in a manner different than what was done originally by the manufacturer.

Even though an alternator produces three-phase AC, as far as the external world is concerned it's a DC machine. There are usually six diodes on two D-ring heat sinks that rectify the AC before it leaves the alternator. What sets an alternator apart from a generator is not only the need to rectify the output of the windings (a generator will produce DC directly), but also the presence of the field coil.

Alternators have a working sim-

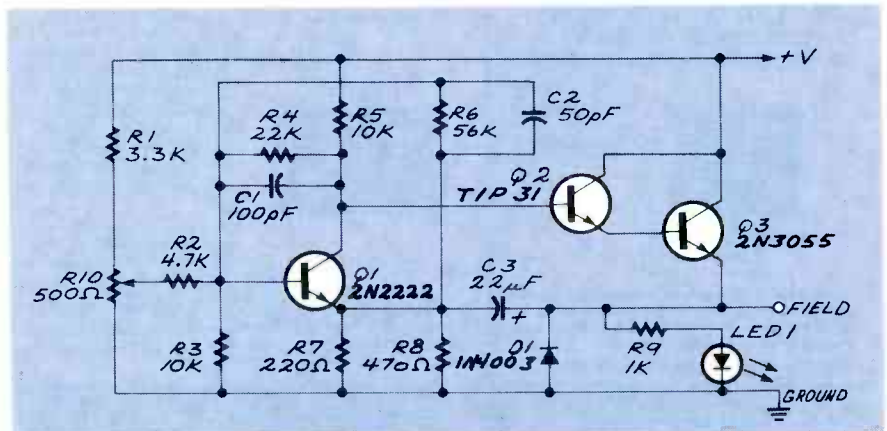

FIG. 1—THIS VOLTAGE REGULATOR can be used with cars and motorcycles. It uses standard parts that are easily and inexpensively available.

Learn to Use Your Computer's Full Potential.

New Career Course from CIE!

If you've been hesitating about upgrading your computer skills because you couldn't find the time or locate the right program to teach you everything you need to know to be successful in today's world of computers, you'll be happy to hear that CIE's new career course can provide you with the computer technology curriculum you seek in an independent study program you can afford to invest your time in.

CIE's COMPUTER OPERATION and PROGRAMMING course was designed and developed by CIE to provide a complete overall understanding of the unlimited potential today's computers offer, once you learn and discover their full capabilities, in today's high tech environment. CIE's new computer course quickly provides you with the electronics fundamentals essential to fully understand and master the computer's technological potentials for your personal and professional advancement. Upon mastering the fundamentals you will move into high level language programming such as BASIC and C-Language and then use that programming in order to relate the interfacing of electronic hardware circuitry to programming software. As a graduate of the Computer Operation and Programming course, you will be able to successfully understand, analyze, install, troubleshoot, program and maintain the various types of electronic equipment used in business, manufacturing, and service industries.

Since 1934, CIE has been the world leader in home study electronics by providing our 150,000-plus graduates with the curriculum and hands-on training they've needed to become successful in



today's highly competitive and computer oriented society. As a CIE student you'll receive a first rate education from a faculty and staff with only one desire. Your future success!

We encourage you to look, but you won't find a more comprehensive computer course anywhere!

And it's a course designed to fit around your lifestyle and commitments today, so you can be assured of professional successes and financial gains tomorrow.

Please, do yourself a favor and send the attached card or fill out and mail the coupon below for more information about CIE's

Computer Operation and Programming course. Do It Today!

Computer not included with course



YES! I want to get started. Send me my CIE school catalog including details about the Associate Degree program (for your convenience, CIE will have a representative contact you - there is no obligation).

Print Name _____

Address _____ Apt. _____

City _____ State _____ Zip _____

Age _____ Area Code/Phone No. _____

Check box for G.I. Bulletin on Educational Benefits Veteran Active Duty



CLEVELAND INSTITUTE OF ELECTRONICS
1776 East 17th Street
Cleveland, Ohio 44114
(216) 781-9400



*A school of thousands.
A class of one.
Since 1934.*

AE21

ilarity to transformers. You can think of the main three-phase windings as the secondary and the field windings as the primary. Like a transformer, the more voltage you have across the primary, the more you'll get out of the secondary. A voltage regulator for an alternator is essentially a controller that monitors the system voltage and tries to keep it at a certain level by adjusting the amount of current (and hence the voltage) present in the field windings.

Given all that, a standard alternator has four terminals that have to be connected to the electrical system. The secondary windings (the main alternator windings) are usually sent to power and ground, but the connections made to the field windings vary with the manufacturer of the car or bike.

The field terminals can be treated in one of the following ways: Both field terminals can be brought out of the alternator and left floating for you to connect any way you want, one side can be grounded inside the alternator (called a grounded field), or one side can be tied to the DC positive inside the alternator (called a pulled-up field).

The schematic in Fig. 1 is designed to work with a system that has a grounded field. Since you've been fooling around with your own designs, you should be able to easily modify it to work with a pulled-up field if that's the situation in your bike. Basically, the voltage regulator monitors the system voltage and controls the field current by modulating Q2 and Q3 (they're set up as a Darlington pair because I found it difficult to get the Darlington I wanted to use). The output is being modulated and the transistors are being run saturated (used as a switch) because they run a lot cooler that way.

The three external connections are +V (connected to the battery), the field (connected to the free end of the field coil), and ground (connected to system ground). Let me repeat that this regulator is designed to work in a system that has a negative ground and in which one side of the field windings is grounded as well. If your system is set up for a pulled up field and you use this circuit, you'll blow up the regulator and possibly destroy some other electrical stuff in the bike as well.

As I said, I've been using this reg-

ulator in both my car and bike without any problem at all. I included LED1 in the circuit because it gives me a visual indication that the charging system (or at least the regulator) is working. You can use the potentiometer to adjust the knee of the regulator.

The setting here will determine what the steady-state voltage of the regulator will be. Moving it to one end will effectively turn off the charging system (although why you'd want to do that is beyond me), and turning it to the other extreme will cause the alternator to put out a lot of juice. That can be handy for those times when your battery is either in need of a charge or you're putting a heavy current demand on the electrical system (lights on in stop-and-go traffic during a heat wave and rainstorm). If you're using the regulator in a car, you can mount the potentiometer and LED inside the car so you can monitor its action and make adjustments while you're driving. The regulator should work well regardless of the construction method you use. I designed a PC board for it and, if you're interested, drop me a line and I'll send you a copy of the foil pattern. Best of luck from a fellow biker.

R-E

HANDS-ON TECHNICAL SEMINARS FOR PROFESSIONALS

"Servicing the Video Laser Disc Player" - EIA / CEG

"Hot-Air Soldering Techniques" - Thomson Consumer Electronics

"Advanced Digital Circuitry - Digital TV" - Toshiba America, Inc.

**"Troubleshooting Tough VCR Mechanical and Electronic Problems" -
Tentel Corp. and Sencore, Inc.**

**"Microprocessor Controls - Troubleshooting Techniques Using the Mitsubishi
Wide-Screen Simulator" - Mitsubishi Electronics America**

Courses **FREE** when registered at the National Professional Electronics Convention
August 5-11, 1991; Nugget Resort, Reno NV.

Full \$230 Registration (at door) includes:

- All Technical Training Seminars (limited seating)
- All Management and Business Seminars
- Continuing Education units for all seminars attended
- Two Day Trade Show
- Head-to-head Meetings with Manufacturers' National Service Managers
- All Sponsored Meals and Functions
- NESDA / ISCET Association Meetings
- Price discounts available for pre-registration

Sponsored by the National Electronic Sales & Service Dealers Association
and the International Society of Certified Electronics Technicians

For more information, contact NPEC '91

2708 W. Berry St., Fort Worth, TX 76109-2356
(817) 921-9061; fax (817) 921-3741

891 RE

FREE
Hands-On
Technology Seminar
1-800-426-2200 Ext. 579



Five ways to look at 100 MHz. Starting at \$2295!

Just check the choices in our line-up of five 100 MHz oscilloscopes:

- **GPIB Programmability**
- **Hardcopy Documentation**
- **100 MS/s Single-shot**
- **Automatic Measurements**

Name your application, we'll provide the solution.

Tek gives you the perfect blend of modern analog real-time and digital technologies in 100 MHz oscilloscopes. Whether it's hardcopy output from a fully programmable real-time scope, automatic measurements specified to .001%, or 100 MHz, 100 MS/s single-shot performance, no one has the

choices Tek does. To see it all, call your Tek rep or 1-800-426-2200. The closer you look, the more you'll appreciate Tek.



One company measures up.

Tektronix
COMMITTED TO EXCELLENCE

CIRCLE 92 ON FREE INFORMATION CARD

Earn Your B.S. Degree in ELECTRONICS or COMPUTERS



By Studying at Home

Grantham College of Engineering, now in our 41st year, is highly experienced in "distance education"—teaching by correspondence—through printed materials, computer materials, fax, and phone.

No commuting to class. Study at your own pace, while continuing on your present job. Learn from easy-to-understand but complete and thorough lesson materials, with additional help from our instructors.

Our Computer B.S. Degree Program includes courses in BASIC, PASCAL and C languages — as well as Assembly Language, MS DOS, CADD, Robotics, and much more.

Our Electronics B.S. Degree Program includes courses in Solid-State Circuit Analysis and Design, Control Systems, Analog/Digital Communications, Microwave Engr, and much more.

An important part of being prepared to *move up* is holding the right college degree, and the absolutely necessary part is knowing your field. Grantham can help you both ways—to learn more and to earn your degree in the process.

Write or phone for our free catalog. Toll free, 1-800-955-2527, or see mailing address below.

•
Accredited by
the Accrediting Commission of the
National Home Study Council

•
GRANTHAM
College of Engineering
Grantham College Road
Slidell, LA 70460

LETTERS

Write to Letters, *Radio-Electronics*,
500-B Bi-County Blvd., Farmingdale, NY 11735

TONER CARTRIDGE OMISSION

We were shocked and disappointed that Chenesko Products, Inc. was not mentioned by Don Lancaster in *Hardware Hacker* in the May issue of **Radio-Electronics**. The company has been involved with toner-cartridge recharge for five years and sells to both end users and dealers engaged in the recharge business. Our catalog has been out for more than three years, and we carry the most extensive line of products in the industry.

EDWARD W. GRENZIG,
PRESIDENT
CHENESKO PRODUCTS, INC.
62 North Coleman Road
Centereach, NY 11720

BRING BACK THE TUBES

As a working audio professional, after reading his recent *Audio Update* columns, I think it's fairly obvious that Larry Klein simply doesn't know what he's talking about. He and the other "scientific audio authorities" such as Bob Carver and the crew at McIntosh are about as scientific as pro wrestlers.

I work mainly with midwestern pop, country, and jazz recording artists. While few of them are "audiophiles" in the classic sense, very few are not capable of hearing the difference, and preferring older, simpler, and most often *tube* gear over modern stuff sporting superior measurements. Tube condenser microphones such as Neumanns, tube compressors (such as those from Fairchild and Pultec), and most especially, tube guitar amplifiers and effects are very popular and their value is increasing every day. Various companies are now making new tube studio hardware, which, while often expensive, seems to be selling quite well.

Recording-studio owners are not "tweaks" and faddists, but hard-nosed and often intrinsically cheap fellows who buy gear strictly on the basis of the results generated. Producers and artists can hear the difference, and among those who care a great deal about their sound, a good

deal of tube equipment is the rule, not the exception, especially for miking vocals and for guitars.

The bottom line is that the current battery of audio tests are not even close to sufficient for "objective" analysis of what is going on inside audio amplification and processing gear compared to the limits of what even the rudimentarily trained human ear can discern—when its owner's conscious mind has not stopped it from doing so. The "subjectivist" crowd of audio reviewers are only attempting to fill a void in the knowledge accrued on the subject, however successfully, and if Mr. Klein and friends cannot do better, I suggest they leave it to those who can.

To close, I can do no better than to paraphrase L.A. Rollin's famous lexicon: "Spec worship: Sense of life experienced by (audio) objectivists and other breeds of dog."
RICHARD CARYSFORTH
Lenexa, KS

EASIER INDICATOR

I would like to suggest a simpler remedy to the problem posed by T. Waller in *Ask R-E* in the May issue of **Radio-Electronics**. Mr. Waller asked for a visible indication that he is using the print-screen function of his IBM compatible. Your response points to a complicated hardware solution that would not really solve the problem. As I see it, Mr. Waller wants to know when a screen print is in progress, and not just that the print-screen key has been pressed on the keyboard.

A short software routine would provide a simple solution to the problem. The print-screen key press could be determined by intercepting either the BIOS keyboard character fetch routine or, better yet, the actual print-screen routine itself. For example, he could change the BIOS print-screen routine vector to point to his own custom patch. The first thing the patch does is to turn on some kind of indicator that shows a screen print is in progress. When that subroutine returns control to his patch, he can sim-

Now, You Can Eavesdrop On The World. Introducing the new Drake R8 Communications Receiver. It's world class, world band radio, made in the U.S.A. From Perth to the Persian Gulf, Moscow to Mozambique, local or global, you hear events *as they happen* with amazing clarity. Since 1943, Drake



has been setting the standards in electronic communications . . . and then raising them. Today, there's no better shortwave receiver than the Drake R8. **Out-Of-This-World Performance.** The new Drake R8 has more standard features than other shortwave radios. You get wide frequency range (100 KHz to 30,000 KHz), coverage of all world and local bands, and excellent dynamic range. But you also get important features you won't find on receivers costing hundreds of dollars more. A multi-voltage power supply. Pre-amp and attenuator. Five filter bandwidths and synchronous detector. Dual mode noise blanker and passband offset. Non-volatile 100 channel memory. All designed to give you the best reception with the least distortion. **Down-To-Earth Design.** The ergonomic design of the R8 gives you real ease of operation. You have convenient keypad entry, with large, legible controls. The face is bold. Uncluttered. And the liquid crystal display (LCD) is backlit for easy reading. **Try The R8 . . . At Our Risk.** If you're not impressed by Drake's quality, performance and ease of operation, return the R8 Receiver within 15 days and we'll refund your money in full, less our original shipping charge. For more information, or to order, call **TOLL-FREE, 1-800-9-DRAKE-1**. Telephone orders may be placed on a major credit card. \$979.00 (Shipping and handling \$10 in continental U.S. Ohio residents add 6½% tax.) Call **TOLL-FREE, 1-800-9-DRAKE-1** today. You can't lose.

DRAKE

In touch with the world.

R.L. Drake Company • P.O. Box 3006 • Miamisburg, Ohio 45342 U.S.A.
CIRCLE 181 ON FREE INFORMATION CARD

**DIGITAL VIDEO STABILIZER
ELIMINATES ALL VIDEO COPY
PROTECTIONS**



While watching rental movies, you will notice annoying periodic color darkening, color shift, unwanted lines, flashing or jagged edges. This is caused by the copy protection jamming signals embedded in the video tape, such as Macrovision copy protection. Digital Video Stabilizer: RXII completely eliminates all copy protections and jamming signals and brings you crystal clear pictures.

- FEATURES:**
- Easy to use and a snap to install
 - State-of-the-art integrated circuit technology
 - 100% automatic - no need for any troublesome adjustments
 - Compatible to all types of VCRs and TVs
 - The best and most exciting Video Stabilizer in the market
 - Light weight (8 ounces) and Compact (1x3.5x5")
 - Beautiful deluxe gift box
 - Uses a standard 9 Volt battery which will last 1-2 years.

WARNING :
SCO Electronics and RXII dealers do not encourage people to use the Digital Video Stabilizer to duplicate rental movies or copyrighted video tapes. RXII is intended to stabilize and restore crystal clear picture quality for private home use only.

(Dealers Welcome)

ToOrder: \$59.95 ea + \$4 for FAST UPS SHIPPING
1-800-445-9285 or **516-568-9850**
Visa, M/C, COD M-F: 9-6 (battery not included)
SCO ELECTRONICS INC.
Dept CREB 581 W. Merrick Rd. Valley Stream NY 11580
Unconditional 30 days Money Back Guarantee

CIRCLE 185 ON FREE INFORMATION CARD

**CABLE TV
DESCRAMBLER**
How You Can Save Money
on Cable Rental Fees

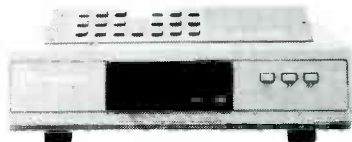

- 1 Unit 5+
- | | |
|--------------------------|-----------------|
| Jerrold SB w/Tri-Bi..... | \$99.....\$70 |
| Super/Tri-Bi (TBM)..... | \$109.....\$75 |
| Jerrold 450 combo..... | \$189.....\$139 |
| Scientific Atlanta..... | \$109.....\$75 |
| SA 8536..... | \$250.....\$195 |
| Pioneer..... | \$109.....\$79 |
| Oak KN12 (w/VS)..... | \$109.....\$65 |
| Hamlin MLD 1200..... | \$89.....\$59 |
| Tocom..... | \$169.....\$129 |
| Stargate converter..... | \$89.....\$69 |
| Panasonic TZPC145..... | \$99.....\$79 |

**US Cable will
Beat Anyone's
Price
Advertised in
this Magazine!**

30 Days Money Back Guarantee
Free 16 page Catalog

Visa, M/C, COD or send money order to:
US Cable TV Inc. Dept. KREB
4100 N.Powerline Rd., Bldg F-4
Pompano Beach, FL 33073
1-800-772-6244

For Our Record

I, the undersigned, do hereby declare under penalty of perjury that all products purchased, now and in the future, will only be used on Cable TV systems with proper authorization from local officials or cable company officials in accordance with all applicable federal and state laws. FEDERAL AND VARIOUS STATE LAWS PROVIDE FOR SUBSTANTIAL CRIMINAL AND CIVIL PENALTIES FOR UNAUTHORIZED USE.

Date: _____
Signed: _____

No Florida Sales!

CIRCLE 186 ON FREE INFORMATION CARD

ply turn off the indicator, since the screen print is now complete.

The indicator itself can be realized in several ways. If the computer is an AT-compatible or better, an easy way out is simply to use the existing scroll-lock LED. I don't know anyone who uses the scroll-lock indicator, so it is probably available. All that Mr. Waller must do is write the scroll lock on character to the keyboard through the proper BIOS call when his patch routine starts. At the end of the routine, he can write out the scroll-lock-off character. An AT or better is required because a PC or XT cannot write back to the keyboard. If the machine is a PC or XT, an external LED indicator can be wired into an unused serial or parallel port pin.

I hope this is a more workable solution to the proposed problem.

JEFF SCHMOYER
Colorado Springs, CO

MIND OVER MONEY

I read with interest Alex Funk's letter in the April issue questioning the "idiocy" of Charles Colby's article, "Build a Macintosh-Compatible Computer" (**Radio-Electronics**, January 1991). I used that article to build the SE-30, and there are a couple of points I'd like to make.

If all you want is a computer, then you are probably better off buying either a new one or a good used one from a friend or a reputable dealer. The real purpose in building your own system is to learn about its design and construction. Half the articles in **Radio-Electronics** are about building devices that are almost always commercially available, although at generally higher costs. But buying the finished product defeats the whole purpose of having electronics as a hobby. The idea of charging yourself 10 hours of construction time, as Mr. Funk does in his cost assessment, makes no sense to the hobbyist.

Mr. Funk also includes in his expenditures for building a Mac \$50 for a motherboard and \$50 for a monitor. He apparently is talking about the Mac 128K, the least powerful of the Macs. His conclusion is accurate: It just isn't cost effective to build such a low-end system. For the same amount of labor—or even less with the help of the article and Colby's video—you can build an SE-30, a far greater value for your money. The

cost of construction falls into the \$2200-\$2400 range, compared to the \$4500 retail cost of the same Mac. While that kind of money might be out of reach for many hobbyists, it still demonstrates the potential in cost savings. I suspect, however, that in Mr. Funk's case, the problem has less to do with money than with one's attitude.

Finally, I would like to say that I found Mr. Colby's article very enjoyable. I had the opportunity to speak with him by phone during the construction of my Mac, and both he and his company were very helpful with their advice.

KEVIN HOLLEY
Reston, VA

IBM-PC PROPONENT

I say "Right on!" to Jeff Holtzman in his response to Raymond Cheng (**Letters, Radio-Electronics**, April 1991).

My first computer was a Texas Instruments TI 99/4A. There were TI 99/4A zealots at that time. The computer served its purpose: It helped my family to better understand computers and to learn a bit about BASIC and other programming. It was treated as an educational tool, but was little more than a toy when it came to useful applications.

Several years later we bought our first MS-DOS personal computer. We delayed this purchase until there was some hint of standardization, competitive marketplace, and long-term usefulness due to its compatibility at work and at home. The entry of IBM clones provided that confidence. In less than three years, we purchased four MS-DOS computers. The second and third were for two children in college (engineering and business). The fourth was to upgrade our own computer and to pass on the first one to our oldest son.

Radio-Electronics has gauged its readership well. In my opinion, **Radio-Electronics** covers items that are of interest to the vast majority of its readers. I like the computer articles, but my primary interest is in new technology and explanations of how devices work. I seldom build anything anymore. However, articles on construction usually describe how the equipment functions, and why. Keep up the good work.

T. LAMAR MOORE
Alexandria, VA

R-E

Why take chances in today's job market?

Graduate as a fully trained electronics professional.

To get ahead and stay ahead in today's economy, you need the electronics training CIE has been providing its 150,000-plus successful graduates with for nearly 60 years.

Meet the Electronics Specialists.

When you pick an electronics school, you're getting ready to invest time and money. And your whole future depends on the education you receive in return. That's why it makes so much sense to go with number one... with the specialists... with CIE!

There's no such thing as a bargain education.

If you talk to some of our graduates, and we recommend you do, chances are you'd find a lot of them shopped around for their training. Not for the lowest priced, but for the best training available. They pretty much knew what was available when they picked CIE as number one.

Because we're specialists we have to stay ahead.

At CIE we have a position of leadership to maintain. Here are just a few of the ways we hang onto it...

Programmed Learning.

That's exactly what happens with CIE's Auto-Programmed Lessons®. Each lesson uses famous "programmed learning" methods to teach you important electronics principles. You explore them, master them completely, before you start to apply them. You thoroughly understand each step before you go on to the next. You learn at your own pace.

And, beyond theory, some courses come fully equipped with electronics equipment to actually let you perform hundreds of hands-on experiments.

Experienced specialists work closely with you.

Even though you study at home, CIE's faculty and staff stand ready to assist via CIE's toll free number. And, each time you return a completed exam you can

be sure it will be reviewed, graded and returned with the appropriate instructional help, you get it fast and in writing from the faculty technical specialist best qualified to answer your question in terms you can understand.

Pick the pace that's right for you.

CIE understands people need to learn at their own pace. There's no pressure to keep up...no slow learners hold you back. If you're a beginner, you start with the basics. If you already know some electronics, you move ahead to your own level.

"Same Day" grading cycle.

When we receive your lesson, we grade it and mail it back the same day. You find out quickly how well you're doing!

State-of-the-art laboratory equipment.

Some courses feature the CIE Microprocessor

Training Laboratory. An integral part of computers, microprocessor technology is used in many phases of business, including service and manufacturing industries. The MTL gives you the opportunity to program it and interface it with LED displays, memory devices and switches. You'll gain all the experience

needed to work with state-of-the-art equipment of today and tomorrow.

New Courses!

CIE now offers two new career courses: Automotive Electronics and Computer Operation and Programming.

CIE offers you an Associate Degree.

One of the best credentials you can have in electronics — or any other career field — is a college degree. That's why CIE offers an Associate in Applied Science in Electronics Engineering Technology. And all CIE career courses earn credit toward your degree.

Which CIE training fits you?

Beginner? Intermediate? Advanced? CIE home study courses are designed for ambitious people at all entry levels. People who have: No previous electronics knowledge, but do have an interest in it; Some basic knowledge or experience in electronics; In-depth working experience or prior training in electronics.

At CIE you start where you fit and feel comfortable where you start, then go on from there to your Diploma, Associate Degree and career!

Today is the day. Send now.

Fill in and return the postage-paid card attached. If some ambitious person has already removed it, cut out and mail the coupon below. You'll get a FREE CIE school catalog, plus complete information on independent home study. Mail in the coupon below or, if you prefer, call toll-free 1-800-321-2155 (in Ohio, 1-800-623-9109).



YES! I want to get started. Send me my CIE school catalog including details about the Associate Degree program. (For your convenience, CIE will have a representative contact you — there is no obligation.)

Print Name _____

Address _____ Apt. _____

City _____ State _____ Zip _____

Age _____ Area Code/Phone No. (_____) _____

Check box for G.I. Bulletin on Educational Benefits Veteran Active Duty

CIE CLEVELAND INSTITUTE OF ELECTRONICS, INC.
1776 East 17th Street • Cleveland, Ohio 44114 • (216) 781-9400



A school of thousands.
A class of one.
Since 1934.

AE20

*Radio-Electronics® Special—Choose Electronics Hobbyists...

SELECT 5 BOOKS

for only **\$4.95** values to \$106.75

when you join the
ELECTRONICS BOOK CLUBSM

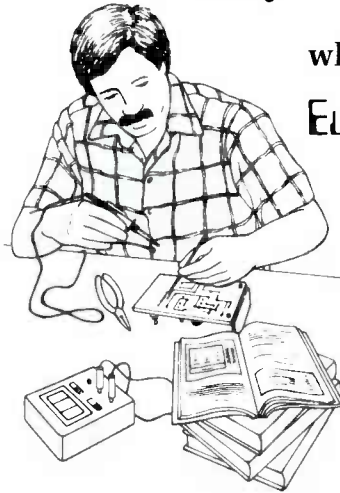

2613P \$17.95

Your most complete source for electronics books for over 25 years.



1367P \$24.95



2867P \$18.95



2883P \$18.95



3321P \$16.95



3343 \$29.95
Counts as 2



3031P \$17.95



2980P \$19.95

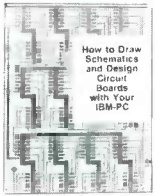

3034P \$13.95

HOW THE CLUBS

BIG SAVINGS: In addition to this introductory offer, you keep saving substantially with members' prices of up to 50% off the publishers' prices.

BONUS BOOKS: Starting immediately, you will be eligible for our Bonus Book Plan, with savings of up to 80% off publishers' prices.

SHOP-AT-HOME CONVENIENCE: Every 3-4 weeks, you will receive the Book Club News, describing the Main Selections and Alternates, as well as bonus offers and special sales, with scores of titles to choose from.

AUTOMATIC ORDER: If you want the Main Selection, do nothing and it will be sent to you automatically. If you prefer another

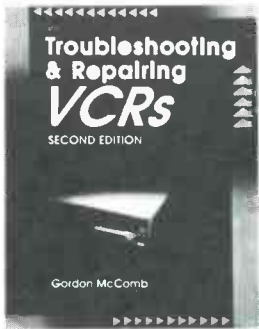

3777 \$32.95
Counts as 2

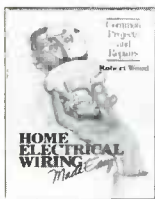

3072P \$16.95



3279 \$36.95
Counts as 2



3270 \$32.95
Counts as 2



2925P \$9.95



3157P \$16.95



3165 \$17.95

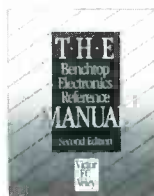

3414 \$39.95
Counts as 2



2707P \$17.95

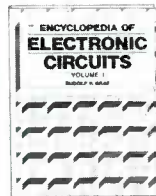

1938 \$60.00
Counts as 3

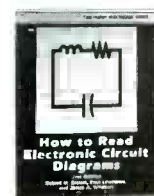

2880P \$14.95

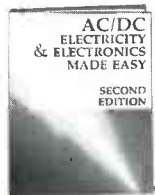

3285 \$25.95
Counts as 2



3632 \$18.95

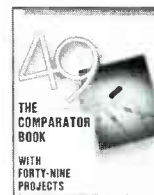

3312 \$23.95



3550 \$34.95
Counts as 2



2865P \$14.95



3274 \$25.95
Counts as 2



3329 \$29.95
Counts as 2



3260P \$14.95



9290 \$36.00
Counts as 2

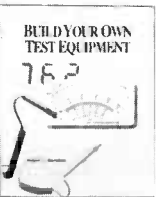

3475 \$27.95
Counts as 2

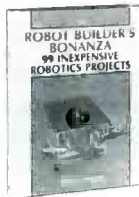

2800P \$16.95



3485 \$27.95
Counts as 2

All books are hardcover unless number is followed by a "P" for paperback. (Publishers' Prices Shown)
A shipping/handling charge and sales tax will be added to all orders.
©1991 Electronics Book Club, Blue Ridge Summit, PA 17294-0810
© by Gernsback Publications, Inc.

RE891

the club that suits your needs... Electronics Engineers...

Take any **3** PROFESSIONAL BOOKS for only **\$9⁹⁵**

when you join the **ELECTRONICS ENGINEERS' BOOK CLUB**



053570-1 \$64.95
Counts as 2



3147 \$38.95



9243P \$12.95

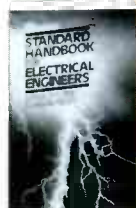

020975-8 \$99.50
Counts as 3



3098 \$44.50
Counts as 2

values
to \$137.40

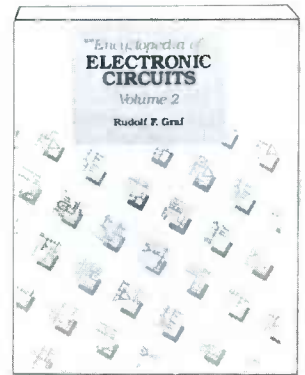

3138H \$60.00
Counts as 2

Your source for quality, affordable, and timely authoritative engineering books.



9255 \$97.50
Counts as 3



2672 \$49.50



8225P \$19.95

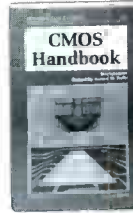

9244P \$18.95

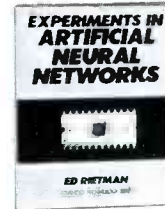

3037 \$24.95



3199 \$52.00
Counts as 2

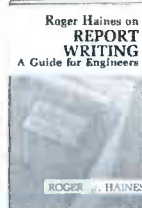

3313 \$22.95



057537-1 \$39.95
Counts as 2



9305 \$59.50
Counts as 2

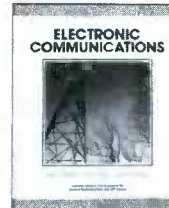

3365 \$34.95



GERALD L. GINSBERG

10016 \$39.95
Counts as 2

WORK FOR YOU!

selection, or no book at all, simply indicate your choice on the reply form provided. You will have at least 10 days to decide. As a member, you agree to purchase at least 3 books within the next 2 years and may resign at any time thereafter. Books purchased for professional purposes may be a tax-deductible expense.

IRONCLAD NO-RISK GUARANTEE: If not satisfied with your books, return them within 10 days without obligation!

EXCEPTIONAL QUALITY: All books are quality editions from the leading publishers and experts in both the electronics and engineering fields, especially selected by our Editorial Board for timeliness and accuracy to members.

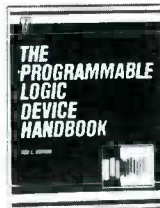

3140 \$49.95
Counts as 2



2962P \$17.95

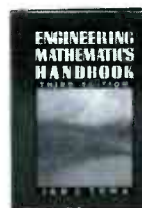

065443-3 \$57.50
Counts as 2



3100 \$75.00
Counts as 3



033559-1 \$27.95

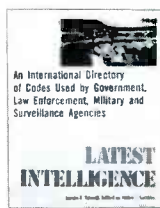

3531 \$26.95



9340 \$44.95
Counts as 2

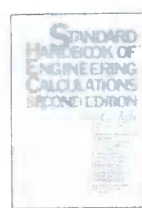

028735-X \$79.50
Counts as 3



3151 \$42.95

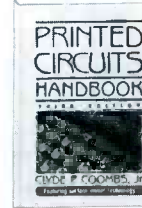

012609-7 \$64.95
Counts as 2



10037 \$44.95

All books are hardcover unless number is followed by a "P" for paperback. (Publishers' Prices Shown)
A shipping/handling charge and sales tax will be added to all orders.
©1991 Electronics Engineers' Book Club, Blue Ridge Summit, PA 17294-0860

DRE891

EQUIPMENT REPORTS

Sharp Model PC-E500 Pocket Computer

We remember the days when four-function calculators were items that cost several hundred dollars and weren't available on key chains at your local dime-store. Back then, an engineer never left his home without his slide rule, and computers were used only for the toughest number crunching. The microprocessor changed everything, of course. The amount of power that can be packed into today's engineering calculator is remarkable. A good case in point is the *PC-E500* from Sharp Electronics Corporation (Sharp Plaza, Mahwah, NJ 07430).

Although we normally call it a calculator, the *PC-E500* is actually more of a pocket computer. It features an 8-bit CPU, a 256K system ROM (including the built-in BASIC programming language), and a 32K RAM (3.8K of system RAM, plus 312 bytes for fixed variables and 28600 bytes for programs and data).

The *PC-E500* offers the operations you'd expect from an advanced calculator: Addition, subtraction, multiplication, division, trig and inverse trig functions, logarithmic and exponential functions, angle conversion, square and square-root capability, power, sign absolute, integer, coordinate conversion, and more. Although we didn't count them, Sharp claims that the calculator features 1101 functions for technical calculations (including scientific formulas, constants, and operations).

The *PC-500E*, at just under $8 \times 4 \times \frac{9}{16}$ inches, is larger than most calculators, even larger than most high-powered scientific calculators. However, that's not necessarily a bad thing—there are 89 keys on the front panel, including a full QWERTY keyboard. (Don't plan on touch-typing; the keys are quite small. Even so, the keyboard is quite usable.) The calculator weighs a little over one half pound, including its four "AAA" batteries and its lithium backup battery. A hard plastic slide-off cover protects the *PC-E500* from damage. The display, which can handle some graphical operations, is a 4-line, 40-column



CIRCLE 10 ON FREE INFORMATION CARD

*Put an engineering
computer in your pocket!*

LCD that measures just smaller than 1×4 inches.

Using the calculator

When the calculator is first powered up, the main menu is displayed so that you can select the operating mode. Five options (BASIC, CAL, MATRIX, STAT, ENG) are presented on the bottom line of the display; you choose one by pressing one of the five "soft" programmable keys below the choices. A sixth choice, AER, is seen only if you hit a menu-scroll key.

The BASIC mode actually consists of two modes: PRO, which allows you to enter or edit BASIC programs, and RUN, which lets you execute stored programs. The CAL, or Calculator mode allows you to use the PC-500E as a standard calculator. The MATRIX mode, as you might expect, allows you to perform operations using matrices, while the STAT mode allows you to do statistical and regression calculations. The AER mode lets you write and solve algebraic expressions. The most interesting mode, of course, is the ENG mode, which lets you use the built-in Engineer Software.

The Engineer Software contains a wealth of built-in programs as well as physical constants. The software is accessed via a hierarchical structure. For example, once you enter the ENG mode, you are presented with five choices above the "soft" function keys: MATH, SCI, ELEC, MECH, and DISTR. While you can probably guess the first four, the last one stands for Distribution and Probability.

The ELEC or electrical engineering function presents you with four additional choices: COMPLX, which performs complex-number calculations, EE-FRM, which displays 14 formulas ranging from Ohm's law to delta-wye transformation to electric resonance. ELEMAG displays 16 formulas for electric and magnetic fields, from Coulomb's law to Faraday's law of electromagnetic induction. Finally, LAPLAC displays 46 Laplace transform formulas.

Formula references, of course, are certainly handy, and some of the other functions present such references as the periodic table and integration formulas. The real power of the calculator is that you can program the soft keys to perform any function you want. So, for example, you could create a program that would ask for coil and capacitor values and then calculate the natural frequency of a tank circuit, and store it to appear under the electrical engineering menu.

Expanding the *PC-E500*

A number of accessories are available to increase the power of the calculator. RAM cards in sizes from 8K to 64K can expand the computer's RAM memory, and can be used for non-volatile program storage thanks to the card's battery backup. A pocket disk-drive is also available, as is a thermal printer/cassette interface. The built-in serial port can also be used for expansion, although the connector is a non-standard one.

All in all, the Sharp *PC-E500* is an effective computer/calculator. Despite its many capabilities—which we wish we had more room to discuss—it's surprisingly easy to use. Any functions that we couldn't use intuitively were covered clearly in Sharps excellent 350-page manual. With a suggested list price of \$229, the *PC-E500* is more than competitively priced in its class. We highly recommend it for any engineer who needs mathematical computing power and a formula-reference book in a pocket-sized package. **R-E**

Your Source To The

Best

Electronics References

Popular Bestsellers!

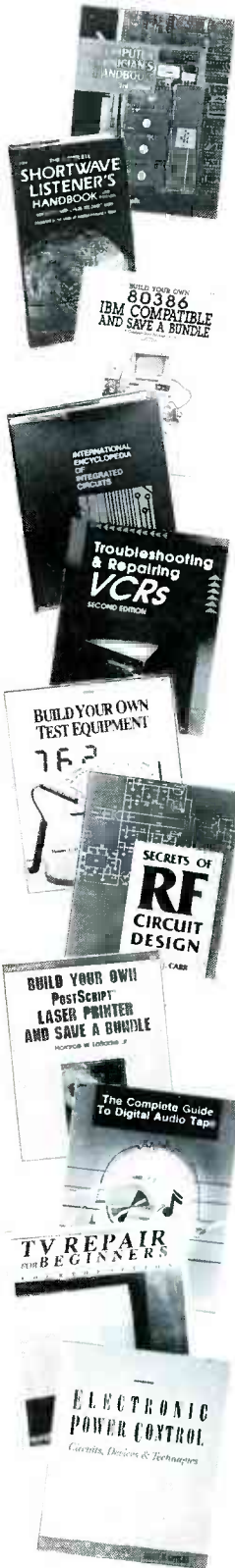

Computer Technician's Handbook—3rd Ed. by Art Margolis. Repair components and systems, perform routine maintenance, diagnose defective equipment, and more with this completely revised edition of the popular bestseller on microcomputers. 590 pp., 409 illus. #3279H, \$36.95

The Complete Shortwave Listener's Handbook—3rd Ed. by Hank Bennett, Harry L. Helms, and David T. Hardy. This third edition is your source to SWL terminology, equipment, operating practices, innovations and more. 304 pp., 96 illus. #2655P, \$17.95

Build Your Own 80386 and Save a Bundle by Aubrey Pilgrim. Get power and efficiency at a down-to-earth price! Photos and detailed descriptions guide you through choosing your components and assembling them. 232 pp., 84 illus. #3131H, \$26.95

International Encyclopedia of Integrated Circuits by Stan Gibilisco. Create circuits for any job, project, gadget, and device imaginable. This jam-packed reference is filled with ICs used in communications, microcomputers, power supplies, control, data-conversion, logic, and more. 1200 pp., illustrated #3100H, \$44.95 (regularly \$75.00)

Troubleshooting And Repairing VCR's—2nd Ed. by Gordon McComb. Solve any VCR malfunction quickly and easily! This second edition updates the best-selling original with new information on technological advances in such areas as Macrovision® and home special effects. 352 pp., 200 illus. #3777H, \$32.95

Build Your Own Test Equipment by Homer L. Davidson. Save money and have a fully-equipped workbench! This money-saving project book gives complete, illustrated instructions for building more than 30 common electronic testing devices. 300 pp., 336 illus. #3475H, \$27.95

Secrets of RF Circuit Design by Joseph J. Carr. Experiments and practical applications make radio-frequency circuit theory crystal-clear. Design, construct and repair the RF circuits you need. 416 pp., 411 illus. #3710H \$32.95

Build Your Own PostScript® Laser Printer and Save a Bundle by Horace W. Labadie, Jr. Get PostScript power—without the PostScript price! Now get step-by-step guidance in laser printer technology, including how they work, what parts to use, where to buy them at the best possible price, and how to put them together. 144 pp., 70 illus. #3738H, \$26.95

The Complete Guide to Digital Audio Tape by Delton T. Horn. Tap into this revolutionary new form of sound reproduction. Reduce distortion and noise, increase dynamic range and get better frequency response with DAT. 256 pp., 98 illus. #3670H, \$23.95

TV Repair for Beginners—4th Ed. by George Zwick and Homer L. Davidson. This hands-on troubleshooting guide provides repair advice for all the latest required procedures in handling transistors, ICs and printed-circuit (PC) boards. 387 pp., 138 illus. #3627H, \$29.95

Electronic Power Control by Irving M. Gottlieb. A consultation guide to the practical side of solid-state power control. One of the first books to cover "new high frequency," enabling you to get the results you want in solid-state RF work. 269 pp., 197 illus. #3837H, \$27.95

Encyclopedia of Electronic Circuits—Volumes 1 and 2 by Rudolf F. Graf. Volume 1, 768 pp., 1,762 illus. 1200 detailed circuit schematics from industry leaders. Volume 2, 744 pp., 728 illus. Picks up where Volume 1 left off, adding over 700 more circuits and more than 100 electronics applications.

Get the two-book set #5376C, \$49.95 and save over 16%! You'll get over 2000 useful and versatile electronic circuit designs!

Encyclopedia of Electronic Circuits—Volume 3 by Rudolf F. Graf. A giant collection of the most widely-used electronic and integrated circuits. Research a particular circuit, find answers to specific problems, or dream up new project ideas. 844 pp., 1053 illus. #3348P, \$29.95

Order the 3-book set and SAVE \$10! (#5460C) now only \$75.90

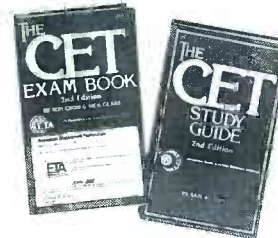

The CET Exam Book—2nd Ed. by Ron Crow and Dick Glass. 226 pp., 211 illus.

The CET Study Guide—2nd Ed. by Sam Wilson. 336 pp., 179 illus. Pass the Associate or Journeyman exams with these guides covering technical information from antennas and digital circuits to test equipment and troubleshooting. #5447C, \$24.90 (regularly \$29.90)

Hot Off The Press!

To Order Call Toll Free: 1-800-822-8158

(in PA, AK, and Canada call 1-717-794-2191) or mail coupon to: TAB Books, Blue Ridge Summit, PA 17294-0840

Fax orders: 1-717-794-2080

Please send me the book(s) below:

Book # _____ Price _____ Book # _____ Price _____

Book # _____ Price _____ Book # _____ Price _____

Please add applicable state and local sales tax (in Canada add \$5.00 shipping and handling) _____

TOTAL _____

Check or money order enclosed made payable to TAB Books.

Charge my VISA MasterCard Am. Exp.

Acct. No. _____ Exp. _____

Signature _____

Name _____

Address _____

City/State/Zip _____

Satisfaction Guaranteed—If you are not completely satisfied, return the book(s) for a complete refund. REB1

AUGUST 1991

NEW PRODUCTS

Use the Free Information Card for more details on these products.

PC-BASED LOGIC ANALYZER.

NCI's PA485 PC-based logic analyzer has been upgraded in two ways: It now operates at 50-MHz on 48 channels in either state or timing modes, and it now comes with Windows 3.0-compatible software. The upgraded board offers 4K bits per channel of memory, 16 trigger words, 16-level trigger sequence, selective storage on each trigger level, and numerous disassemblers for various microprocessors.

The software allows the user to simultaneously view and scroll through a numerical window, a waveform window, and an assembly window. The software also lets the user cut and paste timing diagrams (or any other window) to a word processor for documentation of results, and run the analyzer in one window while working on another application in another window. Other software features include an indexed



CIRCLE 16 ON FREE INFORMATION CARD

on-line help system, a common edit box for multiple windows, and the ability to simultaneously view up to 25 channels in the timing diagram with a VGA monitor or more than 40 channels when used with even higher resolution

monitors.

The complete *PA485* system, including the board, pod, and software, costs \$1895.—**NCI**, 6438 University Drive, Huntsville, AL 35806; Phone: 205-837-6667. Fax: 205-837-5221.

MODULAR INDUSTRIAL PC.

Rapid Systems' PCXI (PC Extended for Industry) is a modular, industrial personal computer based on a 6-, 7-, or 13-slot passive backplane. The PCXI includes a 7½-inch, color Sony Trinitron monitor integrated within a table-top (*PX1012/1490*) or rack-mount (*PX1010/1490*) chassis. Applications include production tests, data acquisition and control, factory automation, networks, and workstations. The rack-mount version, with a 6-slot passive backplane, VGA monitor



CIRCLE 17 ON FREE INFORMATION CARD

with 720 × 480 resolution, 0.26-mm dot pitch, and RGB analog input, makes an ideal test platform. Various single-board computers, from 286 to 486, are available, completely enclosed in metal modules to shield from EMI/RFI emissions. The PCXI features frond-end cabling and connectors and accommo-

dates all commercially available PC boards.

The PCXI modular industrial PC costs \$3095.—**Rapid Systems Inc.**, 433 North 34th Street, Seattle, WA 98103; Phone: 206-547-8311; Fax: 206-548-0322.

TEN-IN-ONE INSTRUMENT.

Boasting the versatility of a complete line of instruments in one 3¾-digit, 4000-count multimeter case, **Global Specialties' Protometer 4000** handheld instrument system features ten test instruments capable of performing 35

measurement functions. The Protometer 4000 combines a DC voltmeter, AC voltmeter, ohmmeter, ammeter, diode/LED tester, transistor tester, capacitance tester, autoranging frequency counter, logic probe, and continuity tester. Special heat-resistant components extend the current-measuring range to 20 amps AC/DC. The one unit can be used to check every electronic component—capacitors, transistors, diodes, resistors, and LED's—eliminating the need for a separate component tester. Standard features include a large LCD readout, 4000-count accuracy, peak hold, and a unique high-voltage warning indicator. The Protometer 4000's rugged construction and drop-resistant case make it well-suited for field-service and industrial-maintenance.

The Protometer 4000 ten-in-one test instrument costs \$139.95.—**Global Specialties**, 70 Fulton Terrace, New Haven, CT 06512; Phone: 203-624-3103; Fax: 203-468-0060.



CIRCLE 18 ON FREE INFORMATION CARD

LOW-NOISE POWER SUPPLIES. Two benchtop DC power supplies from Hewlett-Packard offer high performance plus ripple and noise less than 200 mV RMS. The models HP E3610A (pictured) and HP E3611A feature dual-range outputs and CV/CC operation with automatic mode crossover. The CV mode is for devices requiring constant voltage and the CC mode is for those requiring a constant current. The E3610A's Range 1 is 8 volts/3 amps and Range 2 is 15 volts/2 amps; the E3611A's Range 1 is 20 volts/1.5 amps and Range 2 is 35 volts/0.85 amps. For user convenience, each of the 30-watt power supplies has separate digital displays for voltage and current readout, a CC-set button for setting the current level of the supply



CIRCLE 19 ON FREE INFORMATION CARD

without having to short the output, and mode-indicator LED's to show whether the unit is in CV or CC mode.

The E3610A and E3611A low-noise DC power supplies are list priced at \$300 each.—**Hewlett-Packard Company**, Inquiries, 19310 Pruneridge Avenue, Cupertino, CA 95014; Phone: 1-800-752-0900.

TELECOMMUNICATIONS WIRING TESTERS. According to Paladin Corporation, their Patch Check is the first hand-held instrument that can specifically identify the exact connection point of two connections at each end of a modular cord assembly. Designed to check tele-



CIRCLE 20 ON FREE INFORMATION CARD

phone (RJ11) and computer data link (RJ45) wiring, the Patch Check identifies open, shorted, and cross-connected wires on a clear LED display. It also verifies the correct wiring configuration of unshielded twisted pair in the 10BASE-T baseband medium. The instrument is easy to use: the user simply presses a button to review a sequential comparison of the wire position and continuity of the modular plugs at each end of the cable.

The Patch Check telecommunications wiring tester, complete with installed battery and one-year warranty, has a list price of \$49.95.—**Paladin Corporation**, 3543 Old Conejoc Road, Suite 102, Newbury Park, CA 91320; Phone: 805-499-0318.

STANDARDS-CONVERTER VCR. New technology enables the 50/60 Image Translator VCR from Instant Replay to produce 525-line, 60-Hz NTSC signals from 625-line, 50-Hz PAL/SECAM, allowing the user to play PAL or SECAM tapes on American (NTSC) TV's or monitors. The 50/60 is a true standards converter

CABLE - TV

SIGNAL REMOVERS

• FOR ELIMINATION OF SEVERE INTERFERENCE
• FOR "CENSORING" OF ADULT BROADCASTS



FOR FULL DESCRIPTION OF USES ask for our free brochure

• ATTENUATION - 45 dB TYPICAL
• BANDWIDTH - 4 MHz AT 5 dB POINTS
• INSERTION LOSS - 2 dB

| MODEL | TUNING RANGE | FOR CHANNELS | PASSBAND | PRICE | SHIPPING |
|-------|--------------|--------------------------------|------------|-------|-------------------------------|
| 23H | 50-66 MHz | 2,3 (or 6 meter ham) | 50-300 MHz | \$30 | NO SHIPPING or C.O.D. CHARGES |
| 46FM | 66-108 MHz | 4,5,6 (or any FM) | 50-300 MHz | \$30 | |
| 1417 | 120-144 MHz | 14(A) 15(B) 16 (C) 17(D) | 50-400 MHz | \$30 | |
| 1822 | 144-174 MHz | 18(E) 19(F) 20(G) 21(H) 22 (I) | 50-400 MHz | \$30 | |
| 713 | 174-216 MHz | 7,8,9,10 11,12,13 | 50-400 MHz | \$30 | |

3 for \$75 - 10 for \$200 - mix or match

CALL TOLL FREE FOR C.O.D. OR SEND CHECK TO ORDER
FAST DELIVERY
30 DAY MONEY BACK GUARANTEE (3 FILTER LIMIT)

Star Circuits

P. O. Box 94917
Las Vegas, NV 89193-4917
1-800-433-6319

CRAMOLIN® DeOxidizer

IMPROVES CONDUCTIVITY

DEOXIDIZES • CLEANS • PRESERVES • LUBRICATES
For All Metals, Including Gold!

CRAMOLIN® DeOxidizer improves conductivity by dissolving oxides that form on metal connector and contact surfaces, eliminating unwanted resistance that impedes electrical performance.

CRAMOLIN® is an active ingredient that does not rely on solvents for performance. Due to the excellent migration properties, CRAMOLIN® coats the entire metal surface and protects it from future oxidation.

CRAMOLIN® continues to be the most effective and economical product for improving and maintaining electrical component reliability.

FOR MANUFACTURE, MAINTENANCE AND SERVICE OF:

- Switches & Relays
- Cable Connectors & Adaptors
- Edge Connectors
- Terminal Strips
- Plugs & Sockets
- Gold Plated Connectors
- Potentiometers
- Battery Contacts

USED BY THOSE WHO DEMAND THE BEST:

- Bell & Howell
- Capitol Records
- Dolby Laboratories
- Hewlett Packard
- John Fluke Mfg.
- McIntosh Labs
- MCI (Sony)
- Motorola
- NASA
- Nakamichi
- RCA
- Switchcraft
- and Many More.



Since 1956
CAIG
LABORATORIES, INC.
"Environmentally Conscious"

P.O. Box J
Escondido, CA 92033-3679
(619) 743-7143
FAX: (619) 743-2460

CIRCLE 50 ON FREE INFORMATION CARD



CIRCLE 21 ON FREE INFORMATION CARD

and full-featured VCR with tuner, timer, and wireless remote control. No problems with picture rolling are created in the conversion process, and no vertical hold control is required. The converted signal is recordable. The standard NTSC signal and the converted output are available as composite video, RF, and with S-VHS outputs in S-VHS models. The new conversion technology is compatible with previous and current Image Translator products, and owners of earlier Image Translator VCR's can have their units retrofitted with the 50/60 digital frame standards module to allow complete compatibility with all TV's, monitors, and projection systems, and for standards-conversion purposes.

Prices for the 50/60 Image Translator VCR's begin at \$995.—**Instant Replay**, 2601 South Bayshore Drive, Suite 1050, Coconut Grove, FL 33133; Phone: 305-854-8777; Fax: 305-858-9053.

SCANNER ANTENNA. Designed to provide great reception at a low price—and be rugged enough to withstand wind and weather—the *Super Scanner Stick* from *Electron Processing* receives all scanner frequencies between 25 and 1200 MHz. Its unique internal multiple construction allows the compact antenna to cover such a wide range of frequencies, and an internal 15-dB "Signal Intensifier" amplifier ensures strong signals, even from distant stations. Com-

pletely encased in a PVC tube, the *Super Scanner Stick* withstands weather conditions that routinely destroy other scanner antennas. The 35-inch-long antenna comes completely assembled with mounting clamps for masts up to 2-inches in diameter, so installation is easy. To connect the antenna to its 115-VAC power unit, a 25-foot

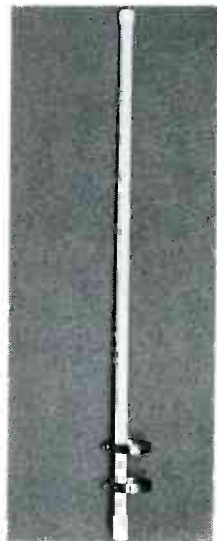

CIRCLE 22 ON FREE INFORMATION CARD

coaxial cable is included; longer lengths are available. The power unit connects to a scanner via a supplied jumper cable.

The *Super Scanner Stick* costs \$80; a 12-VDC version is available for \$84.—**Electron Processing, Inc.**, P.O. Box 68, Cedar, MI 49621; Phone: 616-228-7020.

IC MAILERS. *iTOI Enterprises* offers a simple, low-tech solution to a high-tech problem—how to safely ship delicate electronic components. Designed to physically and electrically protect IC chip sets and circuit components during shipping and transport, the *ChipShip* family of mailers features double-folded corrugated wrap to prevent crushing, conductive foam inserts to prevent ESD



CIRCLE 23 ON FREE INFORMATION CARD

damage, and bonded cushions to reduce vibration and shock damage. Foil-lined versions also offer protection from EMI/RFI radiation. *ChipShip* is a real time saver, replacing the assorted spare tubes, conductive foam, bubble wrap, anti-static foam, foil wrap, and boxes with a single, ready-to-go, pre-assembled package. The containers are available in two sizes (5½ x 3 x 1½ inches and 6½ x 4½ x 1½ inches), in foil-lined and unlined versions, and can hold various quantities of 8-, 16-, 28-, or 40-pin DIP IC's.

ChipShip packages are priced from \$2.95 to \$4.95 each, and are shipped in cartons of 10.—**iTOI Enterprises**, P.O. Box 59, Newton Highlands, MA 02161; Phone: 617-332-1010.

UV EPROM ERASER.

According to *Logibal Devices*, their *Palm-Erase* is the industry's smallest UV EPROM eraser. It is particularly designed for field service and engineering applications where space is at a premium. The *Palm-Erase* can erase EPROM's in less than three minutes. It incorporates a small tray that can accommodate a single 24-, 28-, 32-, or 40-



CIRCLE 24 ON FREE INFORMATION CARD

pin EPROM at a time. The device is packaged in a 4 x 2 x 2-inch gray-and-white plastic enclosure and operates on 110-VAC input power. The bulb intensity is 1.7 μW/cm², and the average bulb lifetime is rated at 3000 hours.

The *Palm-Erase* UV EPROM eraser costs \$49.95.—**Logibal Devices, Inc.**, 1201 NW 65th Place, Fort Lauderdale, FL 33309; Phone: 1-800-EE1-PROM; Fax: 305-974-8531.

PC-COMPATIBLE CIRCUIT BREADBOARD.

With a unique bus-grid design that allows easy access to power and ground hook-up points, *Radio Shack's Archer Experimenter's Plug-In Card* (Cat. No. 276-1598) can be used

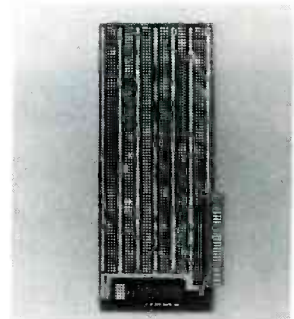

CIRCLE 25 ON FREE INFORMATION CARD

by technicians, students, and hobbyists to breadboard digital and analog circuits. The board is made of sturdy epoxy-glass-composite material and has a card-edge that is compatible with XT-style micro-computer expansion bus connectors. In addition, the *Experimenter's Plug-In Card* has an input/output port designed to hold a right-angle DB25 connector. Board holes are plated-thru for electrical continuity and measure 0.042-inches spaced 0.100-inches on centers. The board itself measures 3⅞ x 10⅛ x ⅛ inches.

The *Archer Experimenter's Plug-In Card* sells

Now with NRI's new training you can enjoy the rewards of a career in computer programming

A top-paying career in computer programming is no longer out of your reach. Now you can get the practical training and experience you need to succeed in this top-growth field.

It's training that gives you real-world programming skills in four of today's hottest computer languages: BASIC, Pascal, C, and COBOL. Hands-on training that includes a powerful IBM AT-compatible computer, modem, and programming software you train with and keep. Comprehensive, at-home training that gives you the competitive edge to succeed in one of today's leading industries. The kind of experience-based training only NRI can provide.

As a trained computer programmer of the '90's, you can enjoy long-term career success. In fact, the Bureau of Labor Statistics forecasts that during the next 10 years job opportunities will increase by 71.7 percent for the skilled computer programmer. With NRI training you can be one of the increasing number of computer programmers using their skills to build a top-paying career—even a business of their own—in this professionally and financially rewarding high-tech field.

▼ The only programming course that includes a powerful AT-compatible computer system and programming software you keep

Right from the start, NRI training gets you actively involved in the challenge of real-world computer programming. You learn how to create the kinds of full-featured, powerful programs today's employers and clients demand. And, unlike any other school, NRI lets you experience first-hand the power of an IBM PC/AT-compatible computer system with modem, a full megabyte of RAM, disk drive, and monitor—all yours to train with and keep.

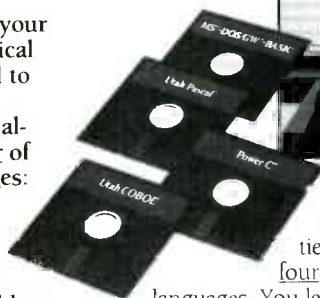
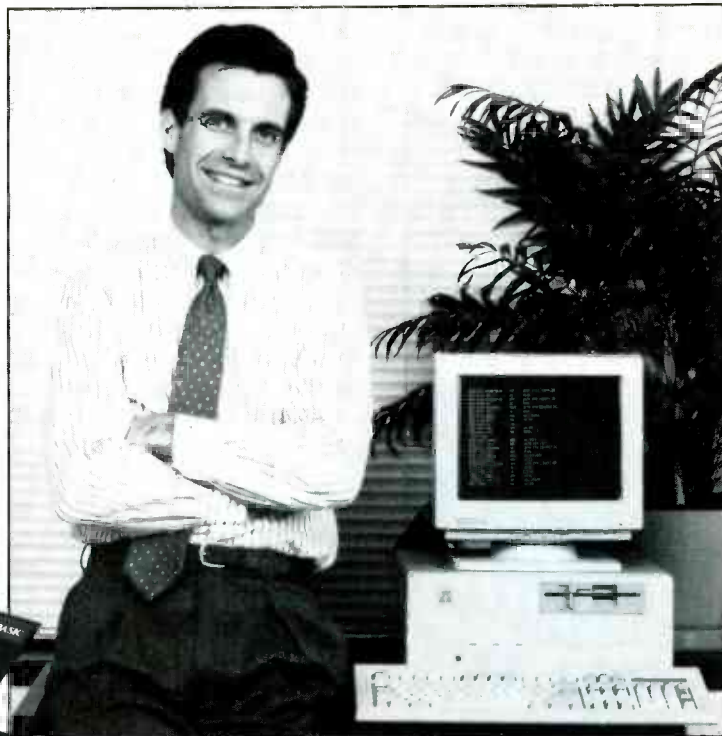

Plus you explore the extraordinary capabilities of not one or two but four in-demand computer languages. You learn to design, code, run, debug, and document programs in BASIC, Pascal, C, and COBOL. In the process you become uniquely prepared for the wide variety of programming opportunities available today.

▼ No previous experience necessary

Immediately, you start getting the money-making job skills you need to secure a future in computer programming—no matter what your background. With NRI training you move easily from computer novice to computer professional with step-by-step lessons covering program design techniques used every day by successful micro and mainframe programmers.

You'll find no heavy textbooks to plow through. No night classes to attend. Instead, NRI's at-home, step-by-step training covers all the bases, guiding you from the impor-

tant fundamentals to real-world methods and techniques. With the help of your NRI instructor—offering one-on-one, personal guidance throughout your course—you quickly gain the skills you need to handle with confidence a wide variety of programming applications. You even use your modem to "talk" to your instructor, meet other NRI students, and download programs through NRI's exclusive programmers network, PRONET.

▼ Send today for your FREE catalog

Now you can have the professional and financial rewards of a career in computer programming. See how NRI at-home training gives you the experience, the know-how, the computer, and the software you need to get started in this top-paying field. Send today for your FREE catalog.

If the coupon is missing, write to us at the NRI School of Computer Programming, McGraw-Hill Continuing Education Center, 4401 Connecticut Avenue, NW, Washington, DC 20008.

NRI Schools

McGraw-Hill Continuing Education Center
4401 Connecticut Avenue, NW, Washington, DC 20008



Check one free catalog only

- | | |
|--|--|
| <input type="checkbox"/> Computer Programming | <input type="checkbox"/> Microcomputer Servicing |
| <input type="checkbox"/> PC Systems Analysis | <input type="checkbox"/> Desktop Publishing and Design |
| <input type="checkbox"/> PC Software Engineering Using C | <input type="checkbox"/> Word Processing Home Business |

Name _____ Age _____
(please print)

Address _____

City _____ State _____ Zip _____

Accredited Member, National Home Study Council

5415-081

for \$29.95 at Radio Shack Stores nationwide.—**Radio Shack**, 700 One Tandy Center, Fort Worth, TX 76102.

CLAMP-ON METER. Amprobe's RS-3 amp/volt/ohmmeter has been upgraded with the addition of high-energy protection to 600 volts. The RS-3 is



CIRCLE 26 ON FREE INFORMATION CARD

fused to protect both the user and the instrument against accidental misapplication. The amp/volt/ohmmeter offers a comfortable shape and locking, all-weather test leads. It also features a magnified rotary scale for easy readings, and a pointer lock that captures readings in hard-to-see places. The full-capacity, locking transformer jaws provide accurate readings and long instrument life.

The RS-3 amp/volt/ohmmeter has a list price of \$74.85.—**Amprobe Instruments**, 630 Merrick Road, Lynbrook, NY 11563; Phone: 516-593-5600.

DC POWER SUPPLIES. Housed in dark metal cabinets that blend in with modern amateur-radio and communications equipment, *Tripp Lite's PR-Series* DC



CIRCLE 27 ON FREE INFORMATION CARD

power supplies give an integrated, professional appearance to any radio or electronics installation. The power supplies provide power practically all types of 12-VDC equipment, including base or mobile radios, test equipment, and other electronic gear. Continuous-duty performance stands up to extended periods of use for reliable operation. The power supplies provide IC voltage regulation, automatic over-current protection, and full-line operation. They are available in 3- to 60-amp sizes.

Suggested retail prices for the *PR-Series* DC

power supplies start at \$38.50.—**Tripp Lite**, 500 North Orleans, Chicago, IL 60610-4188; Phone: 312-329-1777; Fax: 312-644-6505. **R-E**

Try the
Electronics
bulletin board
system
(RE-BBS)
516-293-2283

The more you use it the more useful it becomes.

We support 1200 and 2400 baud operation.

Parameters: 8N1 (8 data bits, no parity, 1 stop bit) or 7E1 (7 data bits, even parity, 1 stop bit).

Add yourself to our user files to increase your access.

Communicate with other R-E readers.

Leave your comments on R-E with the SYSOP.

RE-BBS
516-293-2283

JAN Crystals

your reliable source for a world of crystal clear communication



- Commercial Two-Way
- MicroProcessors
- Amateur/Experimental
- Scanners/Monitors/Pagers
- Satellite-Telemetry
- Plus custom applications

EXPEDITED ORDER SERVICE!
FOR FREE CATALOG,
CALL OR WRITE:

JAN CRYSTALS

PO. Box 06017
Ft. Myers, FL 33906
(813) 936-2397



TOLL FREE 1-800-526-9825
FAX ORDERS: 1-813-936-3750

CIRCLE 104 ON FREE INFORMATION CARD

SUPER LONG PLAY TAPE RECORDERS

12 Hour Model —
USES 120 TAPE
\$119.00*

Modified Panasonic Slimline, high quality AC-DC provide 6 continuous hours of quality recording & playback on each side of cassette for 12 hours total. Includes • Voice level control • Digital counter, etc. TDK -120 Cassette Furnished.



PHONE RECORDING ADAPTER

Records calls automatically. All Solid state connects to your telephone jack and tape recorder. Starts recording when phone is lifted. Stops when you hang up. **\$28.50***
FCC APPROVED



VOX VOICE ACTIVATED CONTROL SWITCH

Solid state. Self contained. Adjustable sensitivity. Voices or other sounds automatically activate and control recorder. Uses either recorder or remote mike. **\$28.50***



* Add for ship. & handling. Phone Adapter & Vox \$2.00 each. Recorders \$5.00 each. Calif. Res. add tax. Mail order, VISA, M/C, COD's OK. Money Back Guarantee. Quantity discounts available. Dealer Inquiries invited. Free data.

AMC SALES INC. Dept A 9335 Lubec Street
Box 928, Downey, CA 90241
Phones (213) 869-8519 1-800-926-2488
FAX (213) 923-1478
Mon-Fri 8-5 PAC. TIME

CIRCLE 108 ON FREE INFORMATION CARD

ATTENTION! ELECTRONICS TECHNICIANS



EARN YOUR
B.S.E.E. DEGREE
THROUGH HOME STUDY

Our New and Highly Effective Advanced-Placement Program for experienced Electronic Technicians grants credit for previous Schooling and Professional Experience, and can greatly reduce the time required to complete Program and reach graduation. No residence schooling required for qualified Electronic Technicians. Through this Special Program you can pull all of the loose ends of your electronics background together and earn your B.S.E.E. Degree. Upgrade your status and pay to the Engineering Level. Advance Rapidly! Many finish in 12 months or less. Students and graduates in all 50 States and throughout the World. Established Over 40 Years! Write for free Descriptive Literature.

COOK'S INSTITUTE OF ELECTRONICS ENGINEERING



4251 CYPRESS DRIVE
JACKSON, MISSISSIPPI 39212

CIRCLE 58 ON FREE INFORMATION CARD

Use The Free Information Card for fast response.

WIRING GUIDE; from **Car Audio Specialists Association/Vehicle Security Association (CASA/VSA)**, 2101 L Street, NW, Washington, DC 20037; Phone: 202-828-2270; \$14.95 (members), \$24.95 (non-members).

Originally presented as a series of articles in CASA/VSA's monthly publication,



CIRCLE 40 ON FREE INFORMATION CARD

the *Mobile Electronics Monitor*, the "Wiring Guide Series" has been released as a set of 12 leaflets complete with an index identifying all vehicles featured and a binder to which additional guides can be added. The guides feature wiring diagrams that identify various OEM radio plugs, color codes, pin positions, and related information. Available separately are individual binders with index and single copies of guides in the ongoing series. To date, 17 guides have been published.

TEST INSTRUMENTS BK-91; from **B&K-PRECISION, Maxtec International Corp.**, 6470 West Cortland Street, Chicago, IL 60635; Phone: 312-889-1448; free.

B&K-PRECISION's full line of electronic test in-

struments—oscilloscopes, IC comparators, digital multimeters, signal



CIRCLE 39 ON FREE INFORMATION CARD

and function generators, video test instruments, component testers, power supplies, probes, and accessories—is covered in this 68-page catalog. With a glossary of terms for each major project category, as well as summaries of key product features and selected product applications, the catalog helps purchasers identify the right instrument for a given task.

Complete specifications are provided both in the detailed product listings and in easy-to-use comparison charts. A complete line of accessories, designed to enhance the functionality of many different test instruments, also is described.

SECRETS OF RF CIRCUIT DESIGN; by **Joseph J. Carr. TAB Books Inc.**, Blue Ridge Summit, PA 17294-0850; Tel. 1-800-233-1128; \$19.95.

This hobbyist's guide to radio-frequency circuit theory and experimentation is written to demystify that part of the electromagnetic spectrum. Aimed at amateur experimenters, ham-

radio operators, shortwave listeners, and electronics students, the book explains in clear, nontechnical language what RF is, how it works, and how it differs from other electromagnetic frequencies.

Broad in scope, with hundreds of helpful diagrams and equations to clarify the text, the book explains how to repair variable circuits, align RF circuits, and cope with electromagnetic interference. With an emphasis on practical applications, the book also shows how to design and wind inductor coils; design and build simple wire

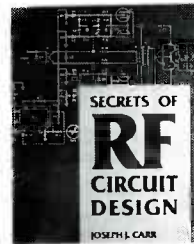

CIRCLE 38 ON FREE INFORMATION CARD

antennas with ten BASIC programs, RF amplifier circuits, and preselector circuits; and build a digital frequency-counter module. Also covered in the guide are the basics of receiver operation, the proper use and repair of components in RF circuits, and the principles of radio propagation from low frequencies to microwave.

BUILDING POWER SUPPLIES; by **David Lines. Master Publishing Inc.**, available at **Radio Shack stores nationwide (Cat. No. 276-5025); \$4.95.**

This book has two main goals: to provide a thor-

ough understanding of how power supplies work, and to explain how the reader can build their own power supplies. Covering both regulated and unregulated

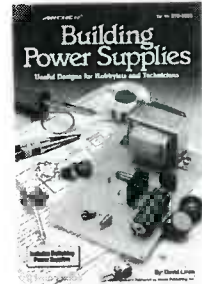

CIRCLE 37 ON FREE INFORMATION CARD

power supplies, the book describes the basic function of each of the components in a power supply and how those components work together to form a functioning unit. Opening with a discussion of the fundamentals of AC and DC energy sources, the book provides in-depth looks at unregulated power-supply systems—including transformation, rectification, and filtering to produce a DC voltage from an AC source—and regulated power supplies—including the basics of how to control a DC voltage to close limits as input or output varies. Complete construction plans are included for three linear regulated power supplies and two switching regulated supplies.

Using easy-to-understand text and clear illustrations, the book guides the reader through the design and construction steps. A chapter on measurements, calibration, and troubleshooting closes the book.

R-E

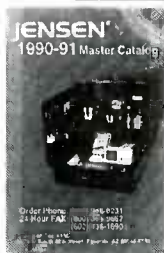

FREE CATALOG! ELECTRONIC TOOLS & TEST EQUIPMENT. Jensen's new Master Catalog, available free, presents major brand name electronics tools, tool kits, and test instruments, plus unique, hard-to-find products for assembly and repair and custom field service kits available only from Jensen. All fully described and illustrated. Enjoy free technical support and rapid, post-paid delivery anywhere in the Continental USA. **JENSEN TOOLS INC., 7815 S. 46th St., Phoenix, AZ 85044. Phone: 602-968-6231; FAX: 1-800-366-9662.**

CIRCLE 115 ON FREE INFORMATION CARD

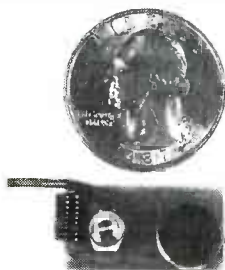

NEW XST500 SUPER-MINIATURE FM transmitter uses Surface Mount Technology (SMT)! Own the smallest high performance FM transmitter available. Transmits whispers to any FM receiver up to a mile away. Uses 9V battery. Complete, easy to assemble kit, with SMT components already assembled to circuit board. **\$39.95 Cash, VISA, MC. COD add \$5. XANDI ELECTRONICS, 201 E. Southern Ave., Suite 114, Tempe, AZ 85282. 1-602-829-8152, (1-800-336-7389 orders only).**

CIRCLE 194 ON FREE INFORMATION CARD

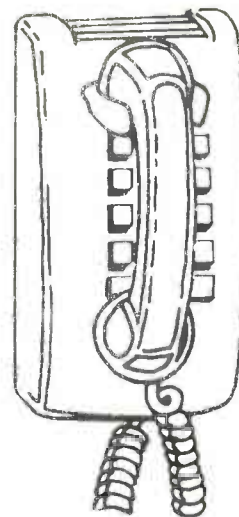

CALL NOW AND RESERVE YOUR SPACE

- 6 x rate \$940.00 per each insertion.
- Fast reader service cycle.
- Short lead time for the placement of ads.
- We typeset and layout the ad at no additional charge.

Call 516-293-3000 to reserve space. Ask for Arline Fishman. Limited number of pages available. Mail materials to: mini-ADS, RADIO-ELECTRONICS, 500-B Bi-County Blvd., Farmingdale, NY 11735.

FAX: 516-293-3315



THE MODEL WTT-20 IS ONLY THE SIZE OF A DIME, yet transmits both sides of a telephone conversation to any FM radio with crystal clarity. Telephone line powered - never needs a battery! Up to 1/4 mile range. Adjustable from 70-130 MHz. Complete kit **\$29.95 + \$1.50 S+H.** Free Shipping on 2 or more! COD add \$4. Call or send VISA, MC, MO. **DECO INDUSTRIES, Box 607, Bedford Hills, NY 10507. (914) 232-3878.**

CIRCLE 127 ON FREE INFORMATION CARD



GET YOUR RECHARGE CATALOG FREE...EARN BIG \$\$ IN YOUR SPARE TIME—All supplies and Do-It-Yourself kits with complete instructions available. Supplies cost from **\$9.95** in qty and you can sell recharged toner cartridges for **\$40.00 to \$55.00** each. Printers include HP LaserJet and Series II, Apple LaserWriter, QMS, etc. Canon PC-25 Copier also. **CHENESKO PRODUCTS, 62 N Coleman Rd., Centereach, NY 11720, 516-736-7977, 800-221-3516, Fax: 516-732-4650**

CIRCLE 183 ON FREE INFORMATION CARD

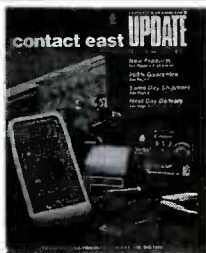

FREE CATALOG OF TEST INSTRUMENTS & TOOLS is packed with thousands of products for testing, repairing, and assembling electronic equipment. Featured are brand name instruments such as Fluke, Tektronix, Leader, Weller, 3M plus many more. Also included are DMM's, hand tools, power supplies, tool kits, test equipment, static supplies plus many other new products. Orders placed by 4 PM are shipped before we go home! **CONTACT EAST, 335 Willow St., No. Andover, MA 01845, (508) 682-2000, Fax: (508) 688-7829.**

CIRCLE 55 ON FREE INFORMATION CARD

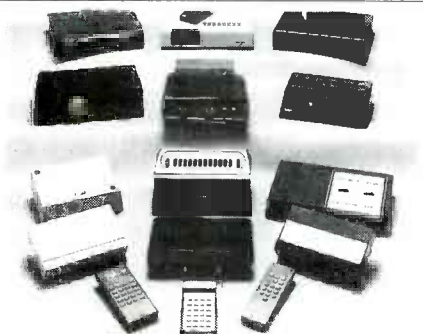

CABLE TV CONVERTERS AND DE-SCRAMBLERS SB-3 \$79.00 TRI-BI \$95.00 MLD-\$79.00 M35B \$69.00 DRZ-DIC \$149.00. Special combos available. We ship COD. Quantity discounts. Call for pricing on other products. Dealers wanted. **FREE CATALOG.** We stand behind our products where others fail. One year warranty. **ACE PRODUCTS, P.O. Box 582, Saco, ME 04072 1 (800) 234-0726.**

CIRCLE 75 ON FREE INFORMATION CARD

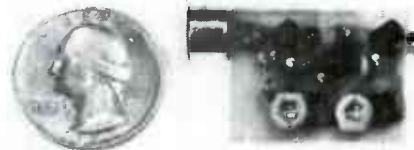

SIMPLY SNAP THE WAT-50 MINIATURE FM TRANSMITTER on top of a 9v battery and hear every sound in an entire house up to 1 mile away! Adjustable from 70-130 MHz. Use with any FM radio. Complete kit **\$29.95 + \$1.50 S + H.** Free shipping on 2 or more! COD add \$4. Call or send VISA, MC, MO. **DECO INDUSTRIES, Box 607, Bedford Hills, NY 10507. (914) 232-3878.**

CIRCLE 127 ON FREE INFORMATION CARD

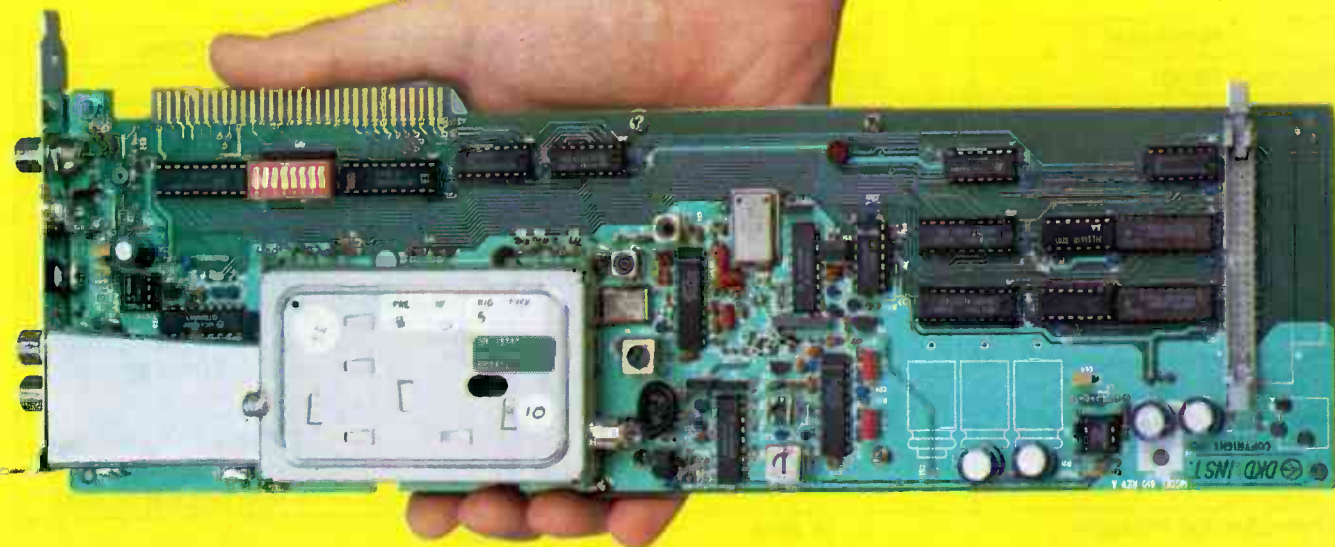

Spectrum Analyzer

DAN DOBERSTEIN AND JOHN CARDONE

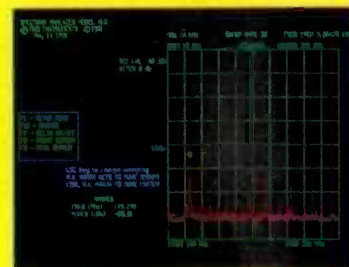

A SPECTRUM ANALYZER IS AN INVALUABLE tool for examining the components of a signal spectrum. It provides a way to measure such parameters as power, harmonic distortion, frequency response, and the amplitudes of complex components. With our calibrated 0.1 to 810-MHz spectrum analyzer, repeatable, accurate measurements of power and frequency are possible. The PC-based spectrum analyzer we present in this article offers features normally found only in instruments costing many times more.

Although the "guts" of the analyzer resides on a single PC board, an IBM XT or compatible computer is required to act as a display, as well as to precisely position phase-locked loops (PLL's) for frequency control and to provide look-up tables for power calibration. Using a PC allows us to include such features as marker and delta-marker readout of frequency and power, hardcopy printer output, instrument-setting memory so that "front-panel" settings can be saved and recalled, and tunable FM demod-

ulation. Refer to Table 1 for complete instrument specifications.

A modestly configured PC is required to work with the spectrum analyzer: A single 360K floppy drive, CGA or EGA video adapters, and 512K RAM are all that's required. The card either plugs directly into an 8-bit slot or, with an external power supply, runs off the parallel printer port. That dual interface allows the user a wide choice of host machines—from basic laptops to high-end machines. So if you already have a PC, for about \$300 you can have a very capable instrument that allows spectrum analysis from 0.1 MHz to over 800 MHz.

Before we go into the theory behind our spectrum analyzer, let's briefly discuss what this instrument actually does, and how it operates.

Spectrum analyzer displays

Electronic signals, whether they are periodic, aperiodic, or transient, can be shown in a time-domain plot where the amplitude is a function of time (left

side of Fig. 1). All time-domain plots have an associated spectrum that can be graphically described in a frequency-domain plot where the amplitude of the signal is a function of frequency. (Mathematically, that's done using the Fourier transform.) It is in the frequency-domain where the spectrum analyzer draws a picture, so that you can analyze the signal spectra in question.

A spectrum analyzer is used to display the power distribution of a signal as a function of frequency, as shown in the right side of Fig. 1. It is basically a tuned receiver with selectable frequency ranges and intermediate-frequency (IF) bandwidths. A spectrum analyzer separates an input signal into its various frequency components and displays each component as a vertical line on a CRT. The height of each vertical line on the display represents the amplitude of each frequency component, the horizontal position of each line indicates the frequency location.

Figure 1 shows three examples of input signals represented in

TABLE 1—SPECIFICATIONS

| Parameter | Highband | Lowband | Notes |
|-----------------------------|--|---|--|
| Frequency Range | 50-810 MHz | 0.1-100 MHz | |
| Available Spans | 0.625, 1.25, 2.5, 5, 10, 25, 50, 100, 200, 300, 400, 500, 600, 800 MHz | 0.625, 1.25, 2.5, 5, 10, 25, 50, 100 MHz | 0.625 MHz to 800 MHz |
| Resolution Bandwidths (RBW) | 10 KHz, 280 kHz | 10 kHz, 280 KHz | Maximum frequency resolution is 10 kHz |
| Power Accuracy* | ±3 dB | ±3 dB from 4–100 MHz (Below 4 MHz, ±5-6 dB) | With min. 6-dB (50-ohm) pad on input. |
| Sensitivity | > -98 dBm | > -92 dBm | With internal attenuation set to 0 dB and 50-ohm source. |
| VSWR Input (50 ohms) | <1.2 (6 dB) | <1.3 (10 dB) | 50-ohm pad on input. |
| Spurious Response (Birdies) | < -95 dBm | < -92 dBm | Unit outside of PC case, 50-ohm terminal on input. |
| Intermodulation Products | < -95 dBm | < -90 dBm (280-kHz RBW) | |
| Dynamic Range | >58 dB (all bands and RBW's) | | |
| Internal Attenuation | 0, 10, and 20 dB | | |
| Maximum Input Power | +10 dBm | | |
| Frequency Accuracy | <10 kHz | | Limited by 10-kHz RBW. |
| Reference Oscillator | 4.000 MHz crystal, ± 100ppm | | All VCO's phase-locked to this reference. |
| FM Demodulator | 280-kHz bandwidth, quadrature detection, manual volume control. Tuning stepsizes 125 kHz at 280 kHz RBW; 62.5 kHz at 10 kHz RBW. | | FM demodulator is for wideband FM. Narrow-band FM is demodulated, but because of the 10-kHz RBW, it cannot be seen on the display. |
| Power Requirements | +5VDC at 0.45A, +12VDC at 0.12A | | |
| Interfaces | PC bus or parallel interface (Centronics) | | |
| System Requirements | 360K disk drive, EGA or CGA graphics adapter, 512K Ram, DOS 3.0 or higher. | | |

*The power accuracy noted above is for factory calibrated units. Kit builders who use the generic calibration tables will degrade by about 3 dB from the above numbers, assuming proper adjustment. Relative power accuracy within a narrow band (less than 25 MHz) is usually better than ± 2 dB over a 45 to 50 dB range of power for kit builders and factory calibrated units.

time and frequency domains. When two different signals, f_a and f_b , are simultaneously applied to the input of the spectrum analyzer (Fig. 1-a), two frequency components would appear as vertical lines at 200 kHz (f_a) and 300 kHz (f_b). The amplitude of f_a would be twice that of f_b . With an amplitude modulated (AM) signal applied to the input (Fig. 1-b), the waveform is separated into its carrier frequency, f_c , and two sidebands. An apparently perfect sine wave, f_s (Fig. 1-c), might show harmonic distortion as multiple frequency components of the input signal.

Now that we have an idea of what a spectrum analyzer displays, let's take a look at some of

the techniques used in the operation of these instruments.

Techniques

There are three types of spectrum analyzers: the swept filter, heterodyne, or heterodyne with tracking filter type. Although the swept-filter method (Fig. 2-a) is seldom used, we will discuss it first because it's easy to understand. The swept-filter analyzer sweeps, or tunes, a bandpass filter over the frequency band of interest. The voltage output of the filter is plotted against frequency, resulting in the spectrum display. The problem is that narrow-band, wide-tuning range filters just don't exist.

The most common type of spec-

trum analyzer, however, is the heterodyne type (Fig. 2-b). With that technique, the bandpass filter is fixed at some frequency and a swept oscillator, in combination with a mixer, performs the same function as the swept filter. The fixed filter determines the resolution of the analyzer. The 3-dB bandwidth of that filter is referred to as the resolution bandwidth (RBW). The advantage of mixing, or heterodyning, which converts energy at one frequency to energy at another frequency, is that the filter is cut to a particular frequency and, therefore, its characteristics are fixed. It's also much easier to build a sweepable oscillator than a narrow-band swept filter. Voltage controlled os-

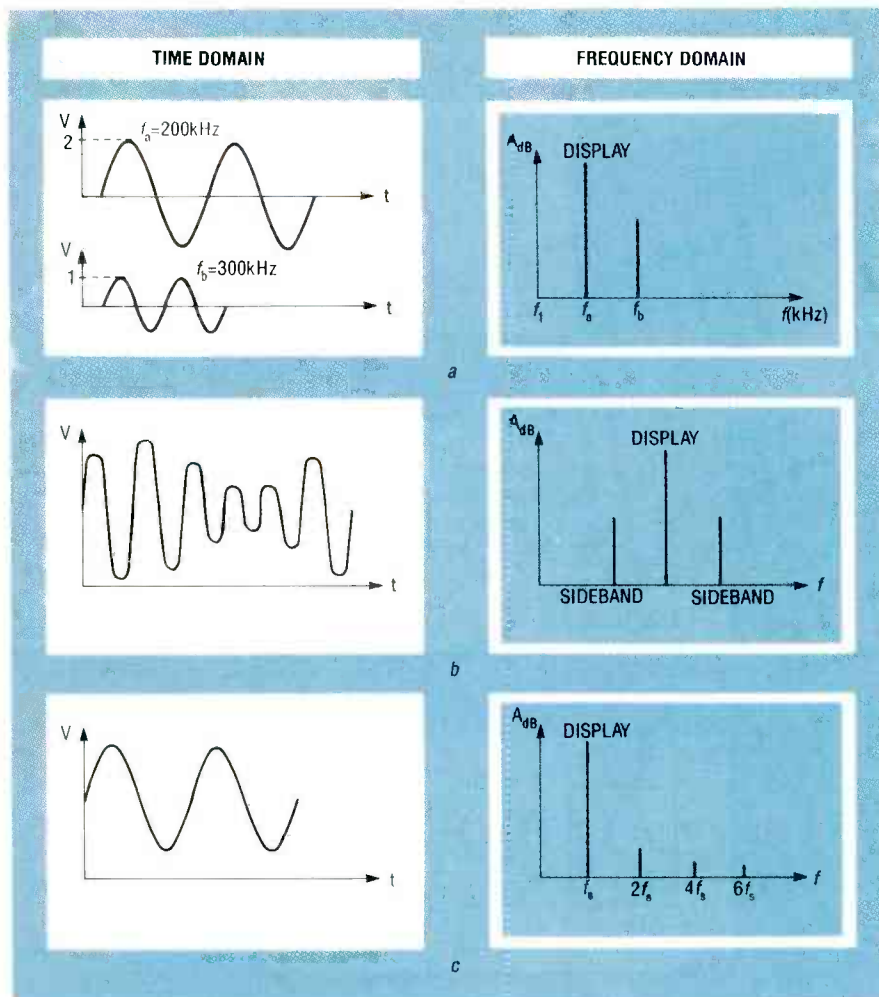

FIG. 1—TIME AND FREQUENCY DOMAINS of input signals. Two different signals applied at the same time results in two separate frequency components (a). An AM signal is displayed with its carrier and two sideband frequencies (b). A sine wave that appears perfect on an oscilloscope may show harmonic distortion on a spectrum analyzer (c).

few hundred hertz.

That accuracy does not come without a price. Phase locking to a given frequency takes a significant amount of time. That results in longer sweep times when compared to sweeping an unlocked VCO. Also, phase-locking forces frequency steps on the VCO, whereas the unlocked VCO can be put at any frequency, at least in theory. For our design, the advantages of PLL's far outweigh the disadvantages.

The big picture

Figure 3 shows the overall block diagram of the spectrum analyzer. At the heart of the unit is a Zenith tuner module (IC17). The tuner takes highband inputs from 50 to 810 MHz and converts them to a 45-MHz IF, which is the first IF stage. After that conversion, the first of two Signetics NE615 receiver IC's (IC16) downconverts the 45-MHz IF to a 10.7-MHz IF, which is the second IF stage. The 10.7-MHz IF is tapped off and sent to another NE615 (IC13) where the 10.7-MHz is downconverted to the standard 455-kHz IF, which is the third IF stage.

Figure 4 shows the circuit of the first 45-MHz IF stage. Of the four local oscillator's (LO's) used, three are phase-locked using Motorola's MC44802 IC (IC14, IC15, and IC23). The LO for the 10.7-MHz IF is crystal-controlled by XTAL1. The PLL's used for the tuner IC also perform band switching, which will be discussed in more detail below. Those PLL's are self contained and have a serial interface. A 4-MHz crystal oscillator (XTAL2, Fig. 5) is used as a common reference for all the PLL's, as indicated in the block diagram (Fig. 3).

The circuit of the second and third IF is shown in Fig. 5. FM demodulation is provided by IC13 and IC16. The output of the 10.7-MHz IF is suitable for wide-band FM such as standard FM radio broadcast. The FM output of the 455-kHz IF is not very clean but can be used for narrow-band FM signals such as voice-only broadcasts. However, only the FM from the 10.7-MHz IF is sent to the audio amp (IC22).

The NE615 receiver IC's (IC13 and IC16) have a received-signal strength indicator (RSSI) out-

cillators (VCO's) are used for that purpose.

There are problems, however, with the heterodyne type. In the mixing process, unwanted frequencies can appear in the fixed-filter bandwidth—additional noise is added and there is a reduction in dynamic range (the difference between the smallest signal detectable and the largest signal allowed).

One way to help eliminate the unwanted heterodyne frequencies is to use tracking filters (Fig. 2-c). A tracking filter is a filter that is tuned by voltage. In practice, tracking filters are used ahead of the mixer stage to reduce the number of frequencies that are mixed with the oscillator. A tracking filter is just a swept filter used in different way. It is designed to follow the oscillator (usually a VCO) so that some protection from the unwanted fre-

quencies is provided.

Our analyzer uses the heterodyne principle in combination with tracking filters. Fixed ceramic 10-kHz and 280-kHz band-pass filters provide the two resolution bandwidths.

Phase locking

Phase locking a VCO takes an otherwise unpredictable beast and nails down its frequency. VCO's, if left on their own, wander in frequency due to temperature, vibration, and a host of other causes. Frequency calibration is impossible with such variations. Frequency wandering can be greatly reduced by phase-locking the VCO with a highly stable source, such as a quartz-crystal oscillator. The VCO's in our analyzer can wander as much as 1 to 5 MHz. When phase-locked to the 4.000-MHz reference, the frequency drift is only a

put. When the RSSI output is read by the computer using an 8-bit analog to digital converter (ADC) (IC12, an ADC0834), raw data is provided for the spectrum display. Extensive use was made of serial interfaces in our analyzer to cut down on computer interface requirements.

The analyzer has two resolution bandwidths that are provided by a combination of ceramic filters. The 10.7-MHz filters (FL1 and FL2) are used for the 280-kHz RBW. Pretuned filters (FL3 and FL4) are used to provide the 10-kHz RBW.

In order to see frequencies below 50 MHz (the tuner's lower limit), an additional mixer and local oscillator (LO), IC24, are used to upconvert the 0.1–100-MHz band to an IF of 145 MHz. The analyzer's lower limit has its own separate input jack, LOWBAND INPUT. The 145-MHz IF is fed to the tuner where it is down converted, as before, to the 45-MHz IF. From here on, the signal is processed as in the highband case (50–810 MHz).

As shown in the block diagram (Fig. 3), an 8-bit DAC (IC7) controls the automatic gain control (AGC) input of the tuner. AGC cancels out gain variations and provides signal attenuation. An 8-bit shift register (IC8) is used to provide IC7 with a serial interface to the host PC.

The signal analyzer supports two interfaces: PC bus and the parallel printer port. Either interface may be used, but not simultaneously. There is no difference in operation between the two interfaces. All frequency, AGC, and RSSI information are communicated over those interfaces to or from the host PC.

Signal processing

Figure 6 shows a block diagram of the RF signal processing. Starting with the 0.1–100-MHz front end shown in Fig. 7, IC24, a Signetics NE602 oscillator/mixer, is used to provide the up-conversion to the 145-MHz IF. The oscillator of the NE602 is buffered by Q5 and sent to PLL2 (IC23) for frequency locking. A varactor diode (D4) in the oscillator of the NE602 allows for voltage control of its frequency. That oscillator is swept from 145 MHz to 245 MHz in order to cover

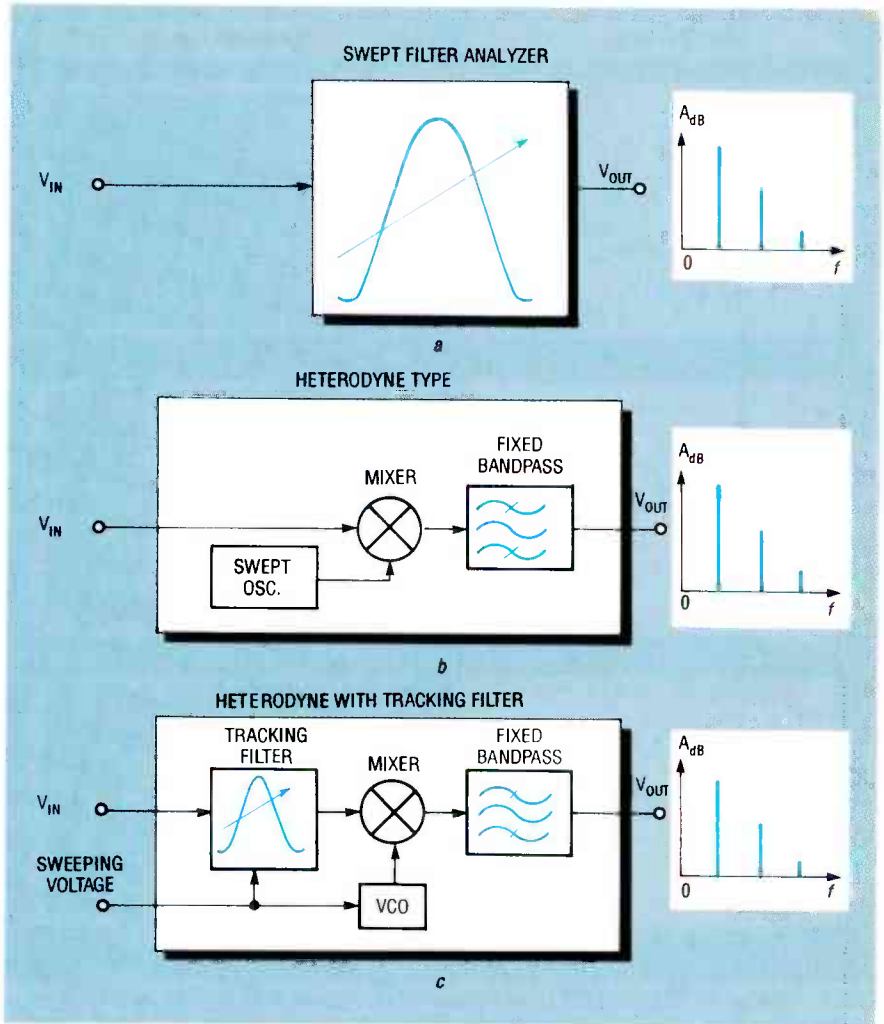

FIG. 2—SPECTRUM ANALYZER TECHNIQUES. The swept-filter analyzer sweeps, or tunes, a bandpass filter over a specific frequency range (a). The heterodyne type uses a swept oscillator in combination with a mixer to sweep over a frequency range; a fixed filter determines the resolution of the analyzer (b). A heterodyne type with tracking filter eliminates undesired heterodyne frequencies (c).

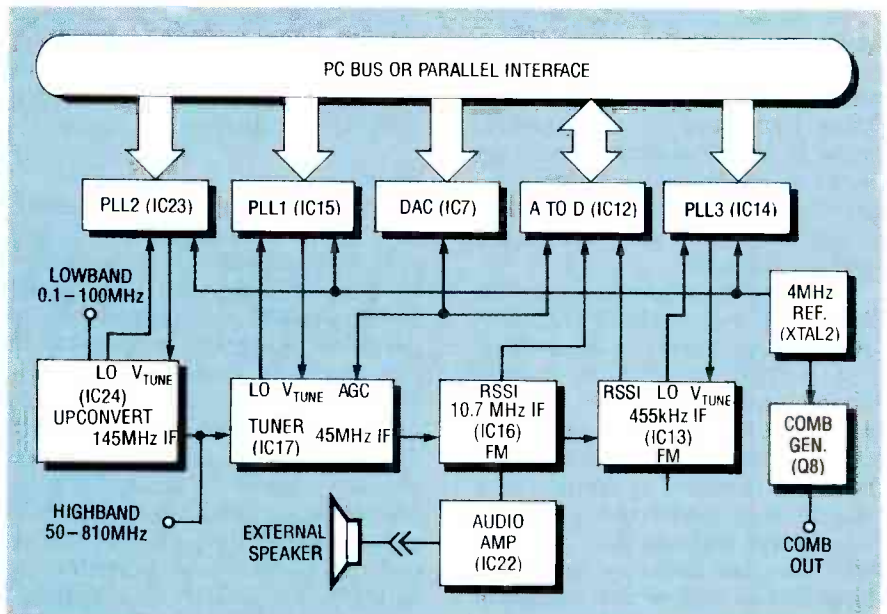

FIG. 3—A BLOCK DIAGRAM OF THE SPECTRUM ANALYZER shows the tuner module, phase-locked loops, receiver blocks, DAC, ADC, and the PC bus connection.

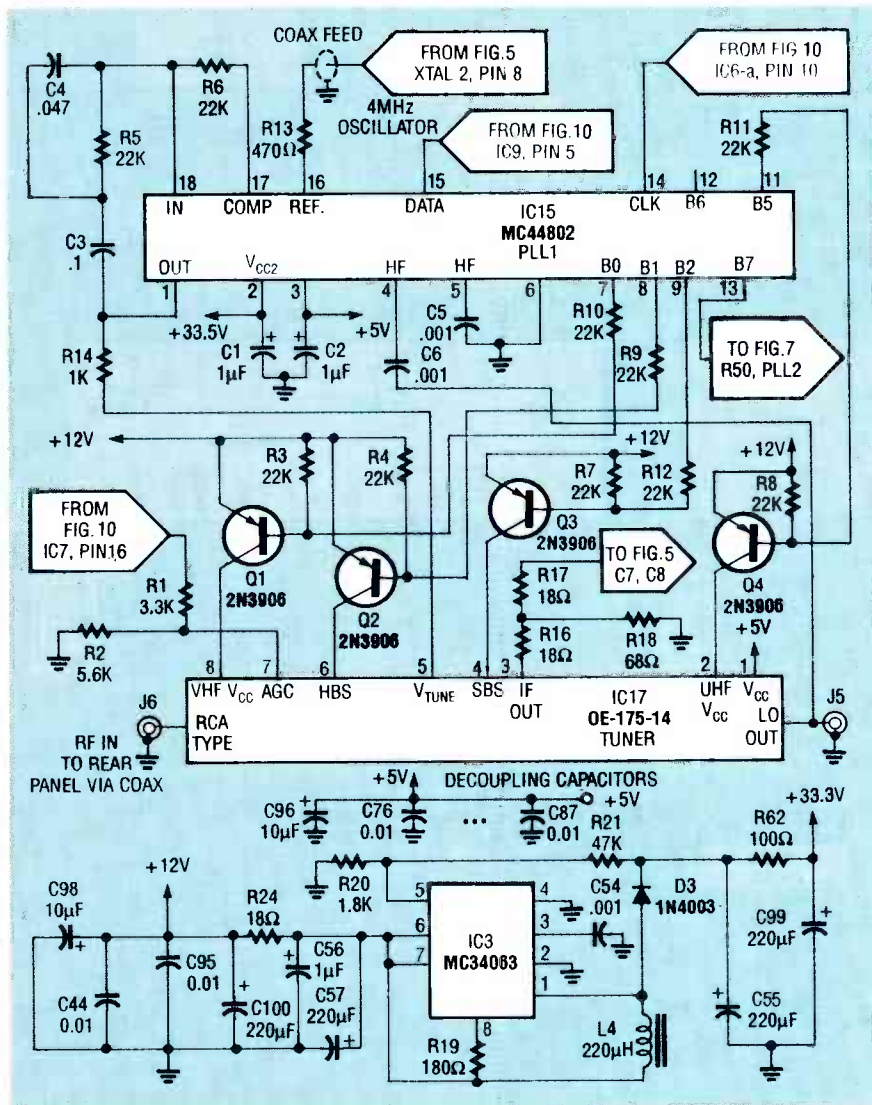

FIG. 4—THE FIRST 45-MHz IF STAGE. The tuner takes highband inputs from 50–810 MHz and converts them to 45 MHz.

the 0.1 to 100-MHz band. A lowpass filter, consisting of L5, C68, and C69, with a 100-MHz bandwidth is used on the input to the mixer to reduce unwanted frequency products at the output. The tuner is set up to receive the 145-MHz IF from the NE602 mixer. The NE602 is turned off for the highband mode using Q7 as an on/off switch, which is controlled from a PLL1 band-switching output.

The input is fed directly into the tuner module (IC17) in the highband case. The tracking filters are internal to the tuner, as previously described. Two bandpass trackers are used with a buffer amp between them. The output of the second filter is fed to the mixer for downconversion to the 45-MHz IF. A 45-MHz bandpass filter, with a 6-MHz band-

width, follows the mixer. The local oscillator (LO) must be 45 MHz above the input signal to mix to the 45-MHz IF. For the 50 to 810-MHz bandwidth, the tuner VCO must have a range of 95 to 855 MHz. The LO from the tuner is internally buffered and is sent to PLL1 (IC15, Fig. 4) for frequency locking.

The 45-MHz IF is fed through a 6-dB attenuation pad (R16–R18, Fig. 4) and a tuned circuit to the mixer for the 10.7-MHz IF. The attenuation pad is used to reduce signal gain from the tuner and to provide a wide-band termination for the output of the tuner mixer. The tuned circuit, consisting of L1, C8, and C7 (as seen in Fig. 5), acts to match impedance, filter, and to adjust the voltage gain. The tuning of L1 (Fig. 5) affects the overall gain and noise floor of

the instrument.

The 10.7-MHz IF is produced by mixing the 45-MHz IF with a 34.3-MHz third overtone crystal-controlled oscillator, which is tuned by L2. The 10.7-MHz output of the mixing process is bandpass filtered by two 10.7-MHz ceramic filters (FL1 and FL2) with a buffer amp between them. The 10.7-MHz IF is fed to a limiting amp and a quadrature tank (T1) to perform FM demodulation. The functions of LO, mixing, amplification, and FM demodulation are performed by IC16. The bandwidth of the 10.7-MHz ceramic filters is 280 kHz.

With the tuner or lowband LO set to a step size of 125 kHz and swept over the frequency span, those filters provide the 280-kHz resolution bandwidth (RBW) using the received signal strength indicator (RSSI) from IC16 (Fig. 5). The RSSI is lowpass filtered by R41 and C43 to smooth the voltage. The lowpass filter forms what is commonly called the video bandwidth. The audio from the 10.7-MHz IF is lowpass filtered by C52 and R43 and sent to the audio amp (IC22).

A sample of the 10.7-MHz IF is taken just after the first 10.7-MHz ceramic filter, passed through FL5 and sent to IC13 for downconversion to 455 kHz. The additional ceramic filter is used to further reduce unwanted mixer products and to provide isolation between the 10.7-MHz IF and the 455-kHz IF.

To produce the 455-kHz IF, a 10.245-MHz LO is needed. That LO is provided by phase-locking the oscillator of IC13 using PLL3 (IC14, Fig. 5). The oscillator of IC13 in our analyzer has been set up as a VCO using a varactor diode (D1). A sample of the LO is buffered by Q6 and sent to PLL3 (IC14) for error generation and locking. The LO is swept from 10.21375 MHz to 10.27625 MHz in step sizes of 3.90625 kHz. That is a total span of 62.5 kHz; the step size of the tuner LO, or the lowband LO when the RBW is set to 10 kHz.

It is necessary to sweep the 10.245-MHz LO because a step size of 3.90625 kHz is not possible with the tuner LO or the lowband LO phase-locked loops. Those step sizes must fall within the 10-kHz bandwidth of the 455-

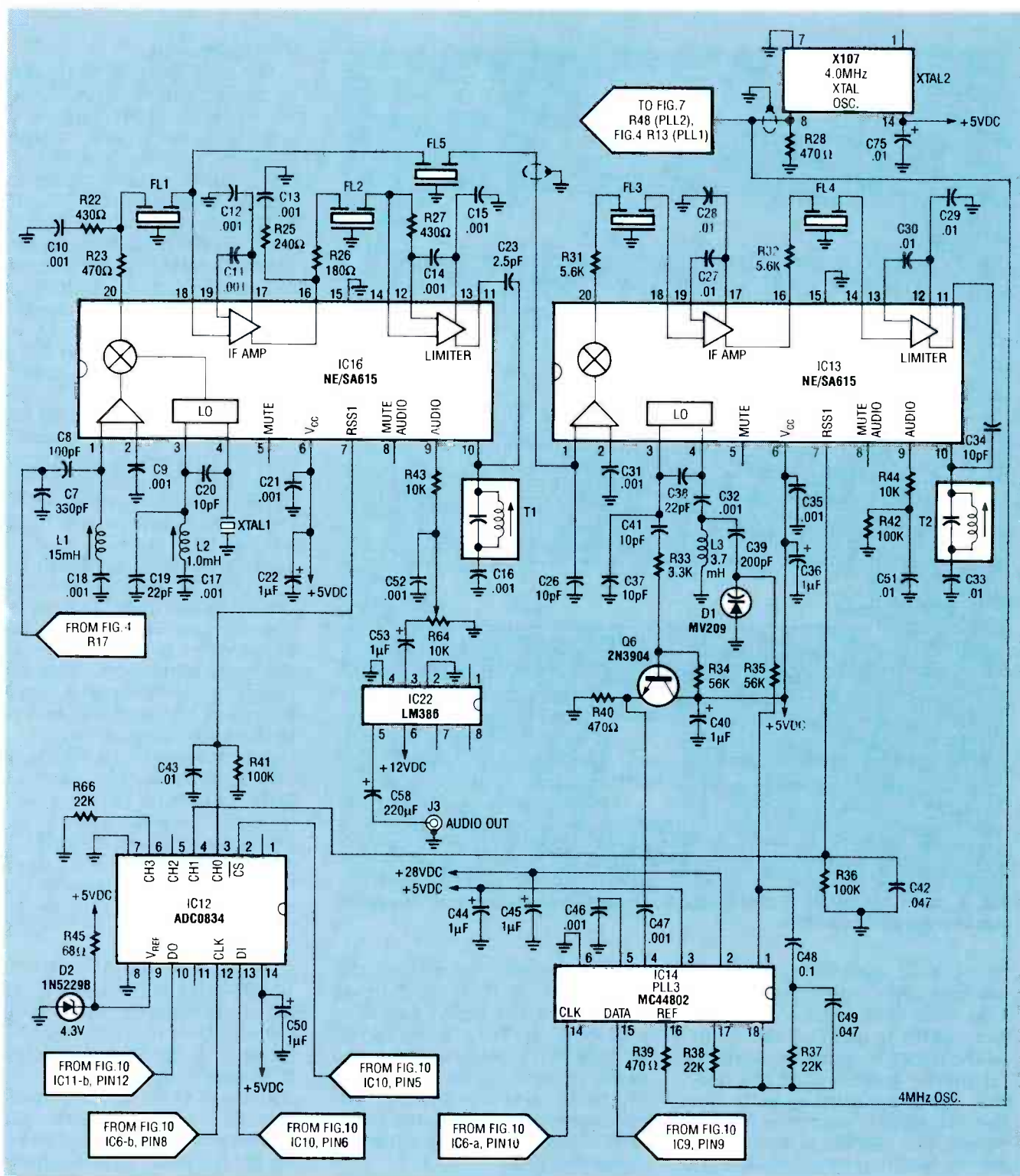

FIG. 5—SECOND AND THIRD IF STAGE. IC16 downconverts the 45-MHz IF to a 10.7-MHz IF, which is tapped off and sent to IC13 where the second IF is again downconverted to the standard 455-kHz IF. Pretuned ceramic filters FL3 and FL4 provide the 10-kHz resolution bandwidth (RBW).

using quadrature detection (T2). The comb generator, shown in Fig. 8, provides a wide-band test signal. Transistor Q8 is biased to produce the harmonics of the 4.0-MHz reference, XTAL2. That signal has detectable harmonics past 500 MHz.

Now that we've gone over the operating theory in some detail,

RADIO-ELECTRONICS

kHz ceramic filters. That combination of dual LO sweeping with the 455 kHz ceramic filters provides the 10-kHz RBW. As with the 280-kHz RBW, the 10-kHz RSSI is lowpass filtered

using R36 and C42. That forms the video bandwidth for the 10-kHz RBW. The 10.245-MHz LO is not swept in the 280-kHz RBW. As with the 10.7-MHz IF, the 455-kHz IF is FM demodulated

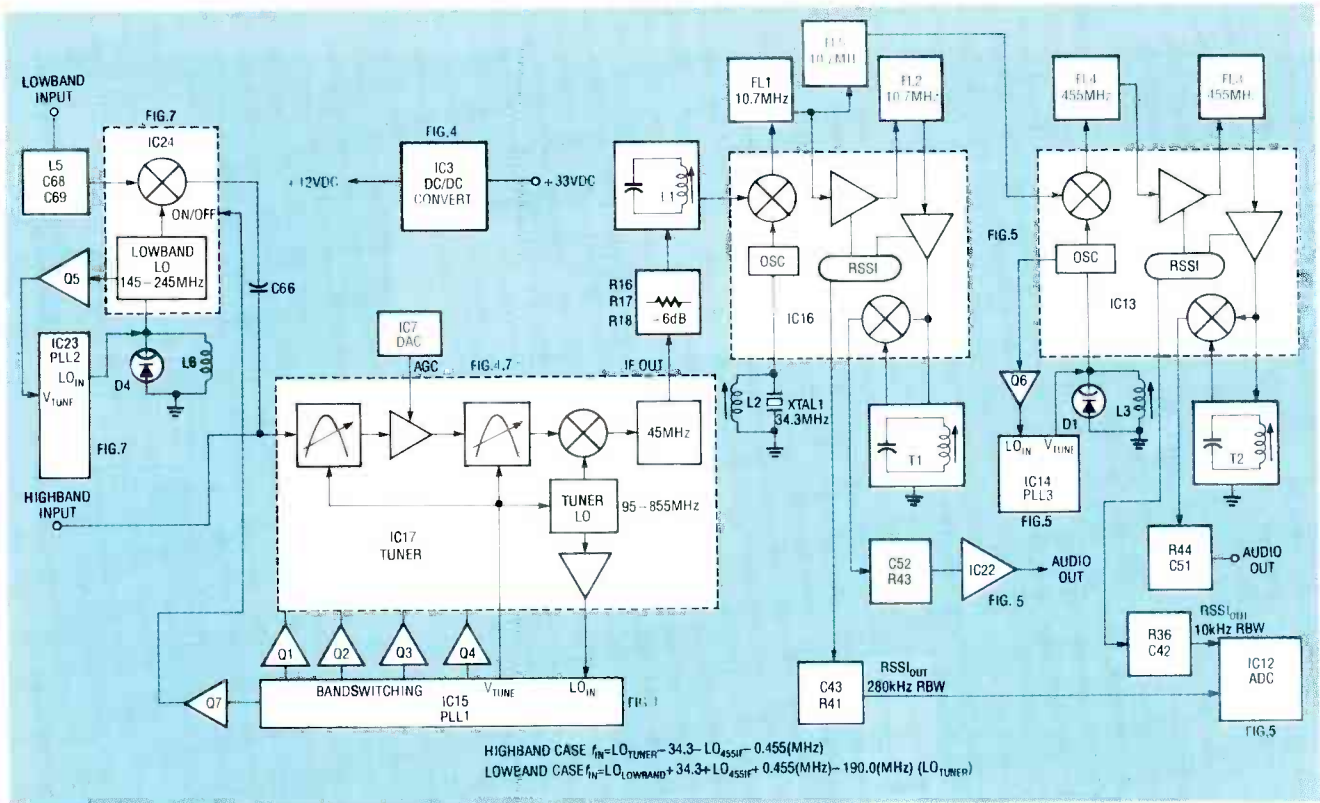

FIG. 6—RF SIGNAL PROCESSING block diagram.

we will discuss some of the more important IC's in this design, and the reason why each of them were chosen.

Tuner module

The tuner is a CATV type made by Zenith. No modifications to the tuner are needed to use it in our analyzer. Along the bottom is a row of pins for the AGC input, +5 VDC, VCO tuning input, IF out and band-switching inputs. Band-switching inputs are used because LO's cannot sweep from 95 to 855 MHz. Instead of one LO, there are four that are switched in one at a time to provide the complete span. Table 2 shows the points where the LO is switched at various frequencies.

The frequencies shown in the table are with respect to the input

frequency; to get the LO frequency, just add 45 MHz. Not only is the LO switched, so is the mixer! Two mixers are used: one for the VHF band and one for the UHF band. The mixers are switched by the same inputs as the LO so no additional switching logic is needed. The band switching results in two effects: a momentary delay in the sweep at the band switching points, and a slight step up or down in the noise floor at the switching points. The switching also affects the operation of the tracking filters. The tracking filters are internally tied to the VCO control voltage so that the input signal is always kept in the center of the bandpass filters.

PLL IC MC44802

The Motorola MC44802 IC,

used in IC14, IC15, and IC23, is tailor made to interface to a band-switching tuner. Figure 9 shows a block diagram of that IC. All the switching logic is provided in the IC for band switching. An on-board prescaler with associated divide counters enables the MC44802 to directly sense and control VCO's up to 1.3 GHz. An error/driver amp is also included that is used to provide VCO tuning voltages from 0 to 35 volts. Programmable reference dividers are also present in the IC. All of the internal settings of the MC44802 are controlled via a three-wire interface.

You can continually change the contents of the VCO divide counter by sweeping the VCO being controlled by the step size selected. You can control tuner band-switching by writing to the band-switching register of PLL1 (IC15). Transistors Q1-Q4 are used as drivers for the tuner band-switching inputs.

To set the PLL to a particular frequency, divide the frequency by the step size, truncate, and insert the resulting number into the divide counter. For example, if you want to set the tuner VCO frequency to 400 MHz using a step size of 125 kHz, the divide

TABLE 2—BAND SWITCHING

| BANDS | SWITCH SETTINGS | | | | |
|-----------------------------|-----------------|----------|-----------|---------|---------|
| | VHF B + | Highband | Superband | UHF B + | Lowband |
| VHF Low (50 to 100 MHz) | + 12 | Open | Open | Open | Open |
| VHF High (100 to 200 MHz) | + 12 | + 12 | Open | Open | Open |
| Super Band (200 to 372 MHz) | + 12 | + 12 | + 12 | Open | Open |
| UHF Band (372 to 810 MHz) | Open | Open | Open | + 12 | Open |
| Lowband (0.1 to 100 MHz) | + 12 | + 12 | Open | Open | + 12 |

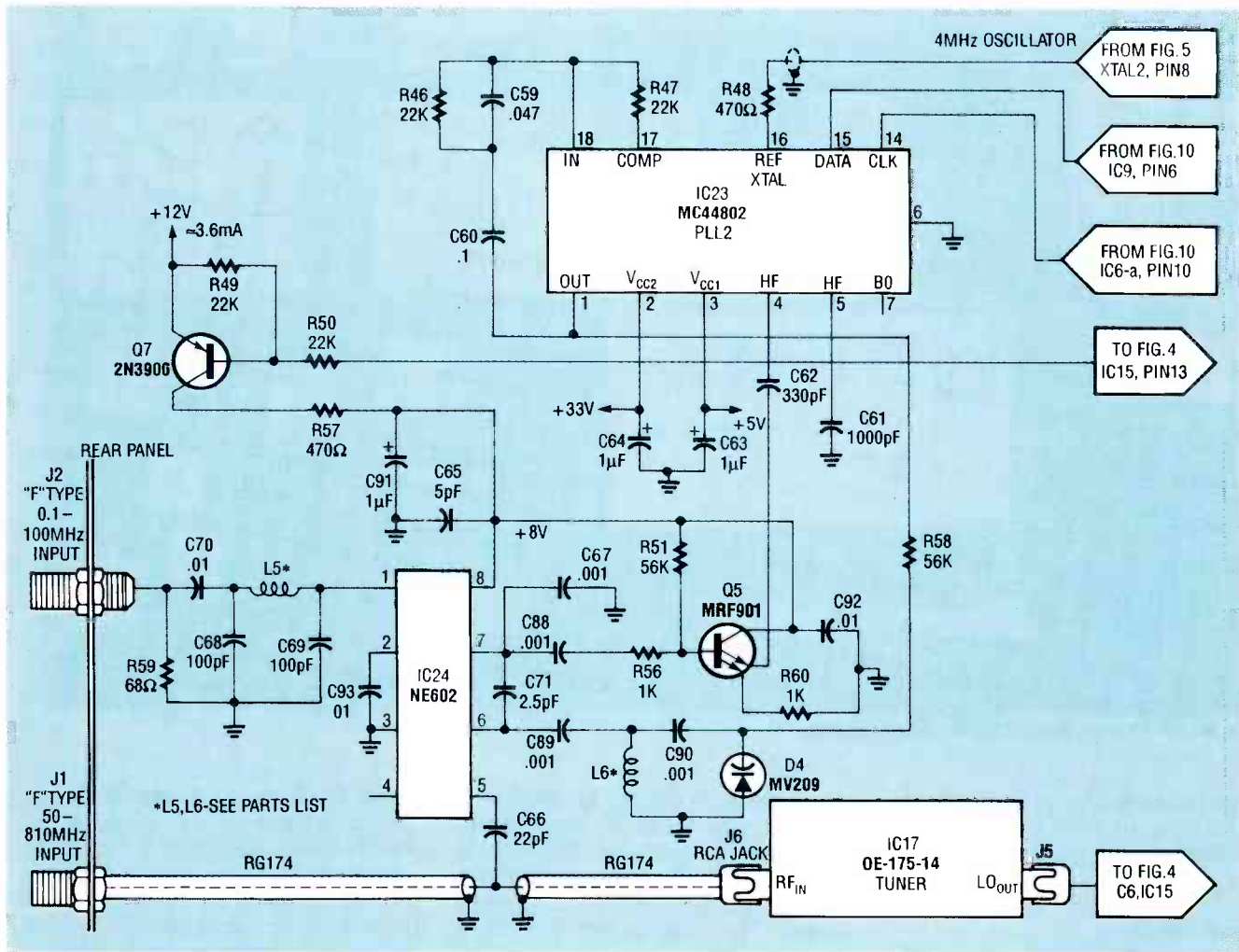

FIG. 7—0.1 TO 100 MHz FRONT END. An oscillator/mixer, IC24, provides the up conversion to the 145-MHz IF. The oscillator in IC24 is swept from 145 MHz to 245 MHz to cover the 0.1 to 100-MHz band.

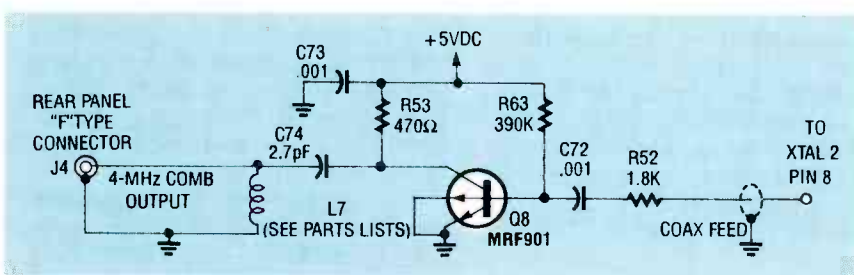

FIG. 8—THE COMB GENERATOR provides a wide-band, 4-MHz test signal.

counter should be loaded with $400/0.125 = 3200$ counts, of course you would also have to set the band switches accordingly. All of that programming is done by the host PC. A complete discussion of the details of programming this IC is too long to be presented here. You can refer to the *Motorola Linear and Interface Data Book* if you would like more information on programming the MC44802. Because of the high frequencies involved, the

use of sockets is not recommended for these IC's.

Receiver IC NE615

The Signetics NE615 IC contains all the necessary components to do frequency conversion. The RSSI output has a 90-dB dynamic range, although our analyzer only has a 60–70-dB dynamic range due to compression in the tuner. The oscillator can be either crystal controlled or LC-tank controlled. If a varactor

diode is added to the LC tank, you have a VCO.

One feature of the NE615 that is not used in our unit is the audio mute. That input allows for killing the audio output when no signal is present. The IF section has a total gain of 90 dB. The high gain can cause stability problems and consequently performance of this IC is greatly effected by circuit board layout. If you build a kit, do not put a normal socket on this chip! Individual, high-frequency, pin-type sockets can be used, but those are hard to come by.

ADC0834

The only thing that is unique about this ADC used for IC12 is its serial interface. Just four wires are needed to interface this IC to a processor. The ADC is used to convert the analog RSSI voltages to 8-bit digital information which is read by the PC. Diode D2 provides the reference voltage of 4.3 volts. This ADC has

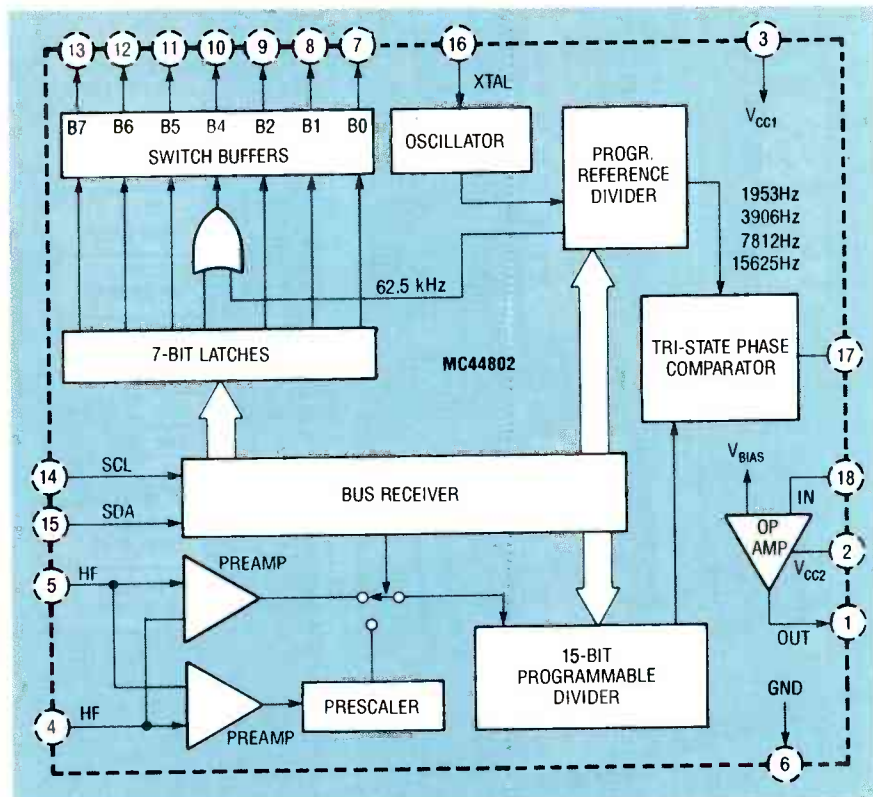

FIG. 9—BLOCK DIAGRAM OF THE MOTOROLA MC44802 IC. All switching logic is provided in this PLL IC. An on-board prescaler with associated divide counters allow the MC44802 to control VCO's up to 1.3 GHz.

four channels, all of which are programmable. Channels 0 and 1 are used for the two RSSI voltages from the NE615's. Channel 2 is unused. Channel 3 is connected to the DAC and is used for self testing. As with the MC44802, the details of programming this IC are too lengthy to be presented here and the reader is referred to National Semiconductor's Databook.

8-bit DAC AD558

This Analog Device's DAC was chosen for IC7 primarily because of its self contained reference and voltage output. It also needs only one supply voltage, +12 VDC. In keeping with the serial interface approach, a 74164 8-bit shift register (IC8) is tied to the input data of the DAC. Three lines, a clock, data, and strobe, are used to insert the shift register and load it into the DAC.

DC to DC converter

The PLL's used need +33 VDC to control the VCO's over the spans used. Motorola's MC34063 (IC3) can be configured as a step-up or -down DC-to-DC converter. In our case it is used to convert

+12 VDC to +33 VDC. Only 3 mA are needed to drive the three PLL's. The input and output voltages are heavily filtered by C57, C100, R24, C55, C99, and R62, as any ripple on the supply will show up as unwanted FM on the LO's.

Interfaces

As already stated, the analyzer can communicate via the PC bus or the parallel port LPT1 through LPT4. A header is provided on the board for a ribbon cable to connect to a Centronics-type adapter cable. If the card is operated external to the PC, an external power supply must be provided. The supply plugs into a 3-pin, Molex-type connector toward the back of the board.

A good quality DC supply with +5 volts at 1.0 amp and +12 volts at 0.4 amps is adequate. None of the DIP switches need to be set to select PC or LPT interface. When the Centronics cable is attached to the computer, it pulls pin 30 of the connector low which selects the LPT interface. The software, however, must be instructed by the user which interface is going to be used. That

is done using the SETUP program, which will be discussed in our next issue. You can actually operate the card plugged into the PC bus using the LPT interface. In that configuration, the PC interface is used just for power.

Figure 10 shows the PC bus interface circuitry. The entire LPT interface is accomplished by using two 74LS244's (IC4 and IC5) and one 74LS04 (IC6). The 74LS244's are three-state octal drivers, which are used to buffer the signals to and from the LPT interface. The PC bus interface is considerably more complex. It consists of one 74LS688 comparator (IC20), two 74LS138's 3-to-8 decoders (IC18 and IC19), two 74LS374 8-bit latches (IC9 and IC10), one 74LS245 bidirectional buffer (IC21), and one DIP switch (S1). The DIP switch is used to select the PC bus address. The default address is 768 decimal. The default DIP-switch setting for S1 is: positions 1-5 on, positions 6 and 7 off.

If another address is desired you will have to use SETUP to change the address used by the software and of course set the DIP switches to the new address. Details of setting the address switches are included in the README.DOC file contained in the SPECAN.ARC file. SPECAN.ARC can be copied from the **Radio-Electronics** BBS (516-293-2283, modem settings: 1200/2400, 8N1). If you never intend to operate the analyzer from the PC bus IC9, IC10, IC18, IC19, IC20, IC21, and IC11 can be removed from the circuit.

The PC interface does a comparison of the address bits A3 through A8 to determine where a block of eight decoded addresses will fall. Although eight READ/WRITE addresses are decoded, only two of the eight WRITE addresses are used, and one of the read addresses. That is modeled after the LPT interface, which has two WRITE registers and one READ register.

Operation

The PC host controls all aspects of the spectrum analyzer's control and data collection. After the user selects a start or center frequency and a span frequency, computations are performed to set up the various LO's that need

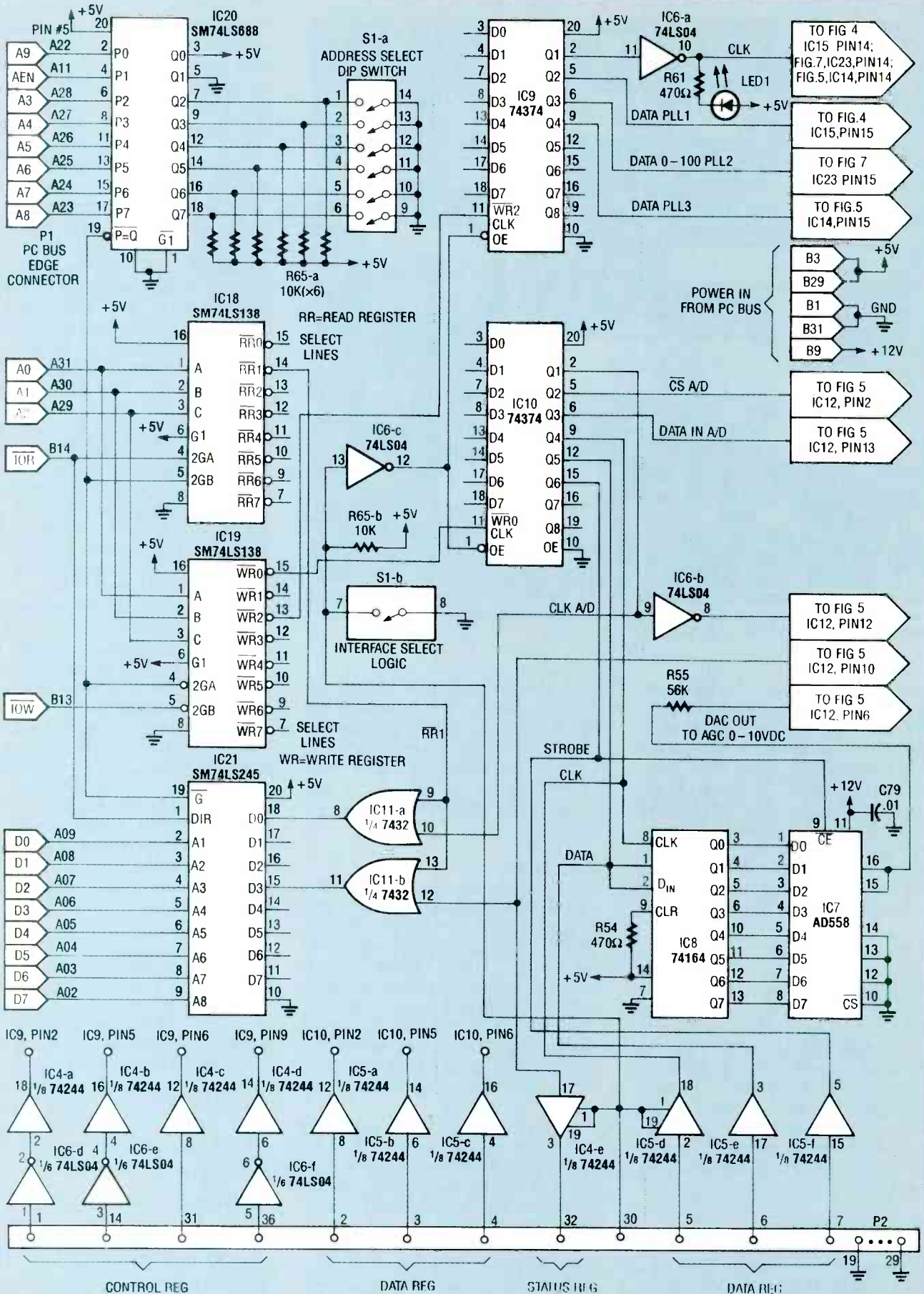

FIG. 10—PC BUS INTERFACE CIRCUITRY. The entire LPT interface is performed by IC4 and IC5. Those two 74LS244's buffer the signals to and from the LPT interface.

PARTS LIST

All resistors are 1/8-watt unless otherwise noted.

R1, R33—3300 ohms
 R2, R31, R32, R43—5600 ohms
 R3—R12, R37, R38, R46, R47, R49, R50, R66—22,000 ohms
 R13, R22, R23, R27, R39, R40, R48, R53, R54, R57, R61—470 ohms
 R14, R56, R60—1000 ohms
 R15, R28—R30—Not used
 R16, R17, R24—18 ohms
 R18, R45, R59, R62—68 ohms
 R19—180 ohms, 1/4-watt
 R20, R52—1800 ohms
 R21—47,000 ohms
 R25—240 ohms
 R26—180 ohms
 R34, R35, R51, R55, R58—56,000 ohms
 R36, R41, R42—100,000 ohms
 R44, R64—10,000 ohms
 R63—390,000 ohms
 R65—10,000 ohms × 7 SIP resistor

Capacitors

C1, C2, C36, C40, C44, C45, C56, C63, C64, C91—1 μF, 50 volts, tantalum
 C3, C48, C60—0.1 μF polyester
 C4, C49, C59—47,000 pF polyester
 C5, C6, C9—C18, C32, C46, C47, C61, C88—C90—0.001 μF ceramic disc
 C7, C62—330 pF ceramic disc
 C8, C68, C69—100 pF, ceramic disc
 C19, C38, C66—22pF ceramic disc
 C20, C26, C34, C37, C41—10 pF ceramic disc
 C21, C35, C67, C72, C73—1000 pF chip
 C22—1 μF, 50 volts, ceramic disc
 C23, C71, C74—2.7 pF, ceramic disc
 C24, C25, C97—Not used
 C27—C31, C33, C50, C70, C76—C87, C92—C95—0.01 μF, ceramic disc
 C39—200 pF, ceramic disc
 C42—0.047 μF, polyester
 C43, C51—0.01 μF, polyester
 C52—1000 pF, polyester
 C53—1 μF, 50 volts, tantalum or polyester
 C54—1000 pF, polyester
 C55, C57, C99, C100—220 μF, 35 volts, electrolytic
 C58—220 μF, 16 volts, electrolytic
 C65—5 pF, ceramic disc
 C75—0.01 μF polyester
 C96—10 μF, 16 volts, tantalum
 C98—10 μF, 16 volts, tantalum

Semiconductors

IC1, IC2—Not used
 IC3—MC34063, step-up voltage regulator, Motorola
 IC4, IC5—74LS244, three-state octal driver
 IC6—74LS04, hex inverter
 IC7—AD558, 8-bit A/D converter, Analog Devices
 IC8—74LS164, 8-bit par out shift register
 IC9, IC10—74LS374, three-state octal driver
 IC11—74LS32, quad OR gate
 IC12—ADC0834, A/D converter, National Semiconductor
 IC13, IC16—NE615, receiver, Signetics
 IC14, IC15, IC23—MC44802, PLL, Motorola
 IC17—OE-175-14, tuner, Zenith
 IC18, IC19—74LS138, decoder
 IC20—74LS688, address decoder
 IC21—74LS245, bus transfer
 IC22—LM386, audio amp, National Semiconductor
 IC24—NE602, oscillator/mixer, Signetics
 Q1—Q4, Q7—2N3906, PNP transistor
 Q5, Q8—MRF901, double emitter NPN transistor, Motorola
 Q6—2N3904, NPN transistor
 D1, D4—MV209 or MV2105, varactor diode, Motorola
 D2—IN5229B, 4.3 volts, Zener
 D3—1N4003, diode
 LED1—Any red light emitting diode
Other components
 L1—T10307, 0.15 mH, 7-mm can type, Toko
 L2—T10407, 1.0 mH, 7-mm can type Toko
 L3—421F224, 5.8 to 3.7 mH, 7-mm can type, Mouser
 L4—220 mH coil, Mouser
 L5—3 turns of #30 AWG wire on #23 drill, LS = 0.138"
 L6—5 turns of #30 AWG wire on #42 drill, LS = 0.2"
 L7—3 turns of #30 AWG wire on #42 drill, LS = 0.138"
 T1—421F128, 10-mm can type, Mouser
 T2—421F102, 10-mm can type, Mouser
 F1, FL2, FL5—SK M1, 10.7-MHz ceramic filter, Toko or Murata Erie

FL3, FL4—CFM2-455E, 455-kHz ceramic filter, Toko
 XTAL1—34.3000-MHz standard crystal
 XTAL2—X107, 4.00-MHz TTL oscillator

S1—7-position DIP switch

Connectors

J1, J2, J4—Female F-type bulkhead connector
 J3—RCA audio jack, PC board mounted (90°)
 J5, J6—F-type connectors are part of tuning assembly (IC17)
 J7—3-pin type, Molex, 0.156" O.C. power connector
 P2—36-pin DIP header
 Two RCA male connectors for coax to tuner connection

Miscellaneous

- Bottom shield—3-7/8" × 3-7/8" single-sided PC board with glass epoxy, copper side facing away from board. Four 1/2-long screws, four 4-40 nuts and bolts, four lock washers and insulating washers.
- Lowband shield—2-1/4" × 2-1/2" sheet metal.
- Rear panel with mounting screws.
- 3 inches of 0.047 miniature coax.
- 16 inches of RG174 coax.

Note: The following items are available from **DKD Instruments, 1406 Parkhurst, Simi Valley, CA 93065; (805) 581-5771:** A complete kit including a 5-1/4 inch disk with all executable files, and manual, \$255.00; Centronics interface cable, \$13.00; power cable, \$4.00; an assembled, tested, and calibrated unit, \$500.00. Send check or US postal money order. Allow 3 to 5 weeks for delivery. California residents add 6% sales tax.

to be swept using the PLL's. Once everything is properly set up, the computer starts sweeping the appropriate LO's and collecting data via the ADC data from the RSSI outputs.

If the RBW is 280 kHz, the 10.7-MHz RSSI output is read. If the RBW is 10 kHz, the 455-kHz RSSI is read. The LO's are not swept continuously, but rather in steps. The steps are determined by the internal settings of the PLL's. The steps used for the tuner are 125 kHz and 62.5 kHz. Steps for the

455-kHz IF are 3.90625 kHz. Those different step sizes are needed to accommodate the two filter bandwidths of 280 kHz and 10 kHz. As the computer is sweeping the LO's, it is also controlling the AGC via the DAC, which is there to keep the gain flat.

The overall basic sequence is

- Command LO's to the next frequency.
- Set AGC level from the look-up table.
- Allow adequate time for set-

tling of PLL's.

- Read RSSI voltage.
- Calibrate RSSI data to Power in dBm.
- Display the power/frequency pair on the screen.
- Repeat.

Those operations are performed continuously by the computer until interrupted by the user.

In our next edition, we'll go over the software, kit construction, tuning, power calibration, and troubleshooting of the spectrum analyzer. **R-E**

ELECTROCARDIOGRAPH

LAST MONTH WE DISCUSSED THE OPERATION OF THE CIRCUITRY for our electrocardiograph, or ECG. This month we'll build the unit and explain how to use it.

ECG construction

The ECG is relatively simple to build. Double-sided plated-through, silk screened, and solder masked PC boards, as well as all of the necessary components, are available from the supplier listed in the sources box. Software for checkout, data-acquisition, and display are also available. However, we are providing foil patterns so you can make your own PC boards, and we'll post the software on the RE-BBS (516-293-2283, 1200/2400, 8N1) as ECG.ARC.

Mount the components according to the parts-placement diagrams—Fig. 1 for the controller board and Fig. 2 for the front-end board. Most of the IC's are CMOS, and must be handled accordingly. A grounded work bench and soldering iron are strongly recommended, and a static wrist strap is also a good idea. We also recommend you use IC sockets for all the IC's.

Install the IC sockets first, making sure they are flush with the PC board. Then solder in the remaining components on both boards. Make sure the polarized components are properly oriented before you solder them. Inspect the finished boards thoroughly before beginning the system checkout. Do not insert the IC's in their sockets just yet, and don't wire the two boards together until instructed to do so. The finished controller board is shown in Fig. 3 and the finished front-end board is shown in Fig. 4.

Checkout

Begin the system checkout by attaching an RS-232 cable between your PC and the DB25 connector on the controller board. The cable should be wired as shown in Fig. 5 if your PC has a 9-pin communications port, or as shown in Fig. 6 if your PC has a 25-pin communications port. Apply power to the PC and measure the voltage at pins 1 and 8 of IC19. Pin 1 should read about +12V and pin 8 about -12V. Also, check pin 14 of IC26 for 5 volts. If those voltages are correct, install the IC's in the controller board and proceed with the checkout.

Install an unused battery in the B3 battery clip and insert the battery in the holder. Press the reset button on the controller board and measure the output of voltage-regulator IC32 at pin 3. If the output is about 5 volts, the power-on circuitry is working. Remove the battery from the circuit.

The remainder of the checkout will be accomplished by running a checkout program that provides a step-by-step procedure to verify each section of the controller and the front end. Some of the checkout software resides in the ECG program EPROM, IC9, on the controller board. The remainder of the checkout software runs on your PC. When the checkout process is complete, install the two boards in the case and prepare to take your first ECG.

Take an ECG

Skin electrodes with a conductive adhesive back-

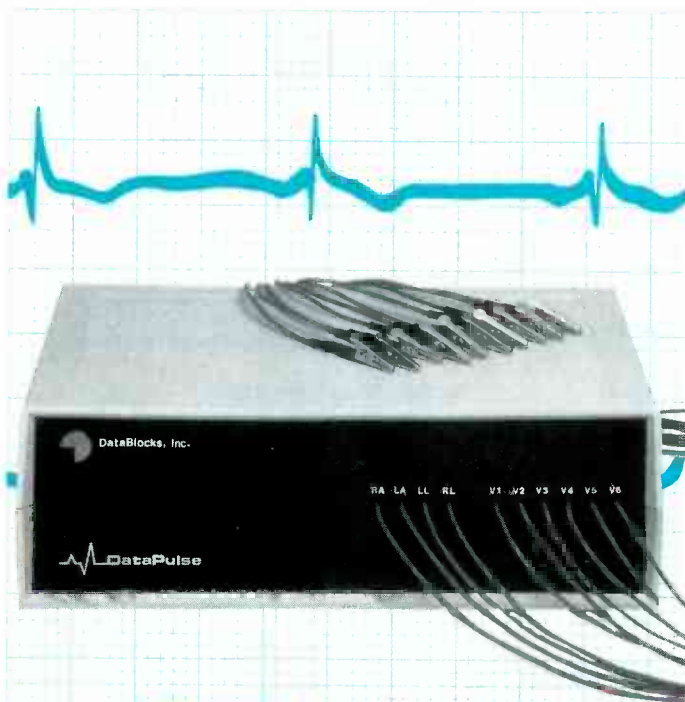

Keep an eye on your health and learn about medical electronics with the Radio-Electronics electrocardiograph.

H. EDWARD ROBERTS, M.D.

WARNING!! This article deals with and involves subject matter and the use of materials and substances that may be hazardous to health and life. Do not attempt to implement or use the information contained herein unless you are experienced and skilled with respect to such subject matter, materials and substances.

Furthermore, the information contained in this article is being provided solely to readers for educational purposes. Nothing contained herein suggests that the monitoring system described herein can be or should be used by the assembler or anyone else in place of or as an adjunct to professional medical treatment or advice. Neither the publisher nor the author make any representations as for the completeness or the accuracy of the information contained herein and disclaim any liability for damages or injuries, whether caused by or arising from the lack of completeness, inaccuracies of the information, misinterpretations of the directions, misapplication of the information or otherwise.

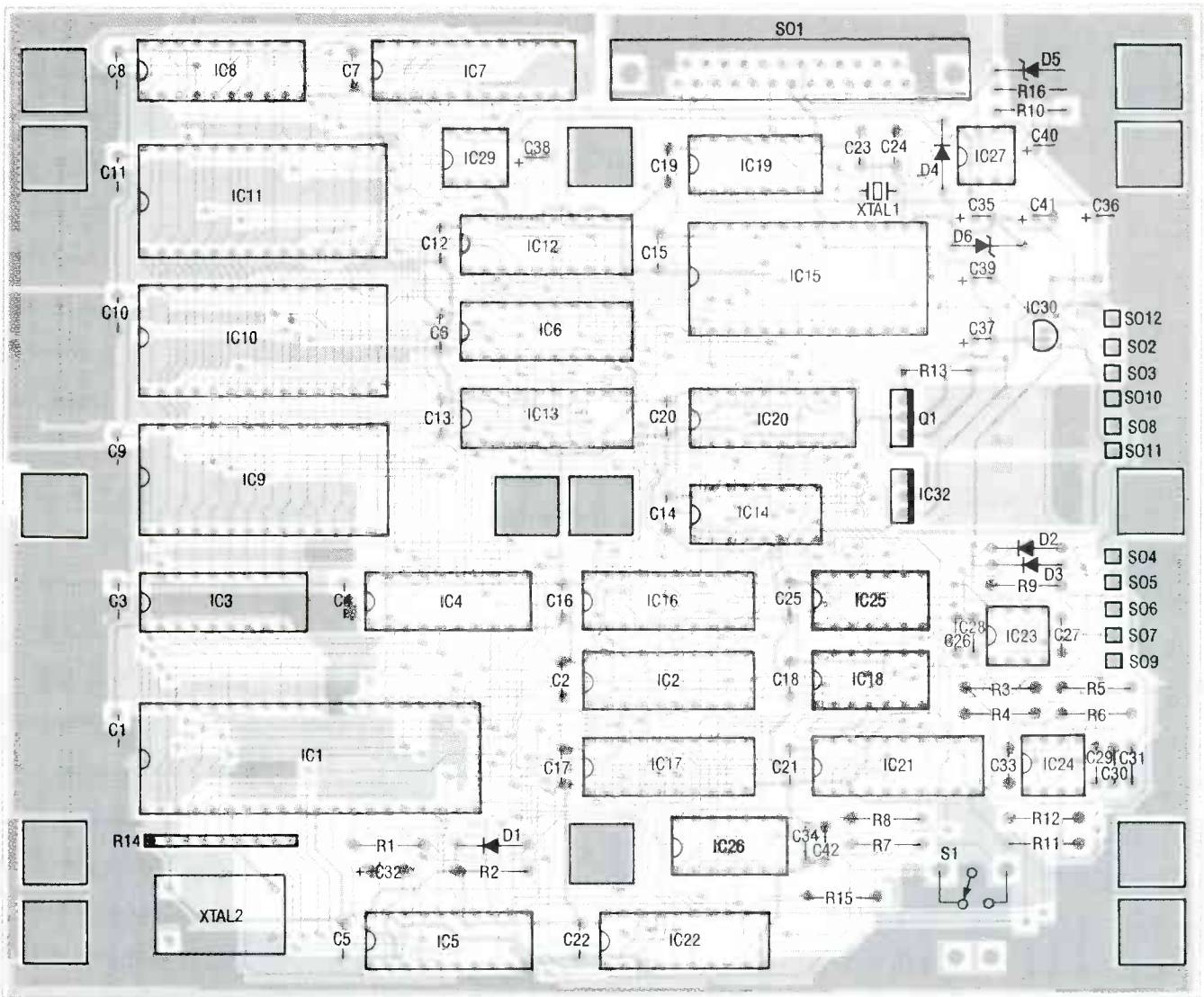
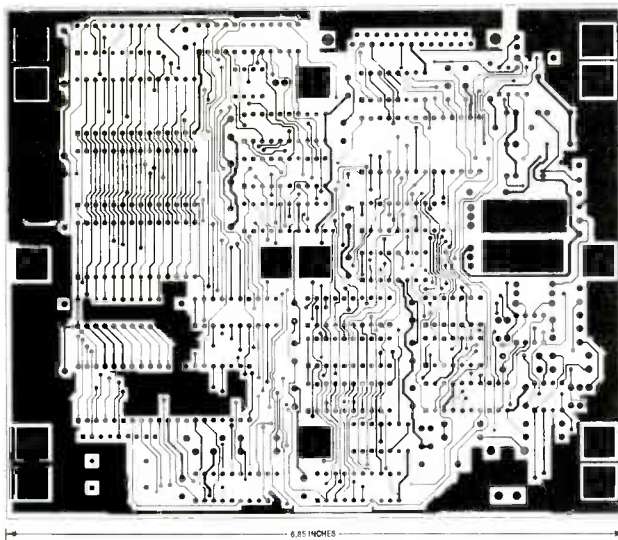

FIG. 1—MOUNT THE COMPONENTS for the controller board as shown here, and use IC sockets for all the IC's to reduce the risk of component damage during assembly.

ing are recommended to attach the leads from the ECG to the body. The electrodes are available

from the source listed in the sources box. Stick one electrode on each wrist and ankle and at

each of the six torso locations shown last month in Fig. 3. Use alcohol to clean the area where



COMPONENT SIDE of the controller board.

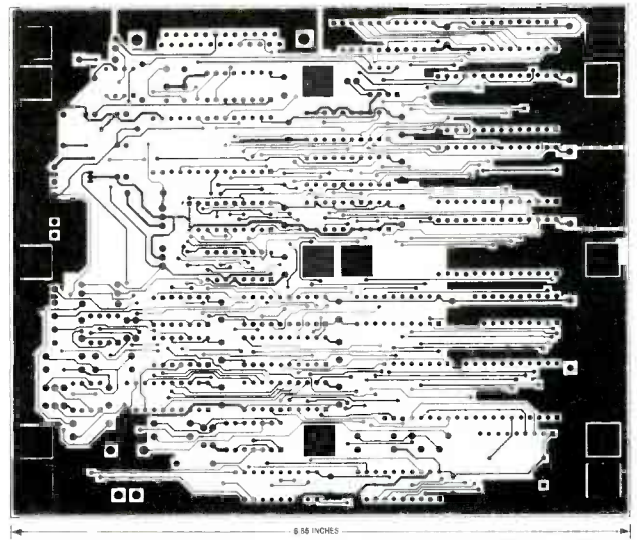

SOLDER SIDE of the controller board.

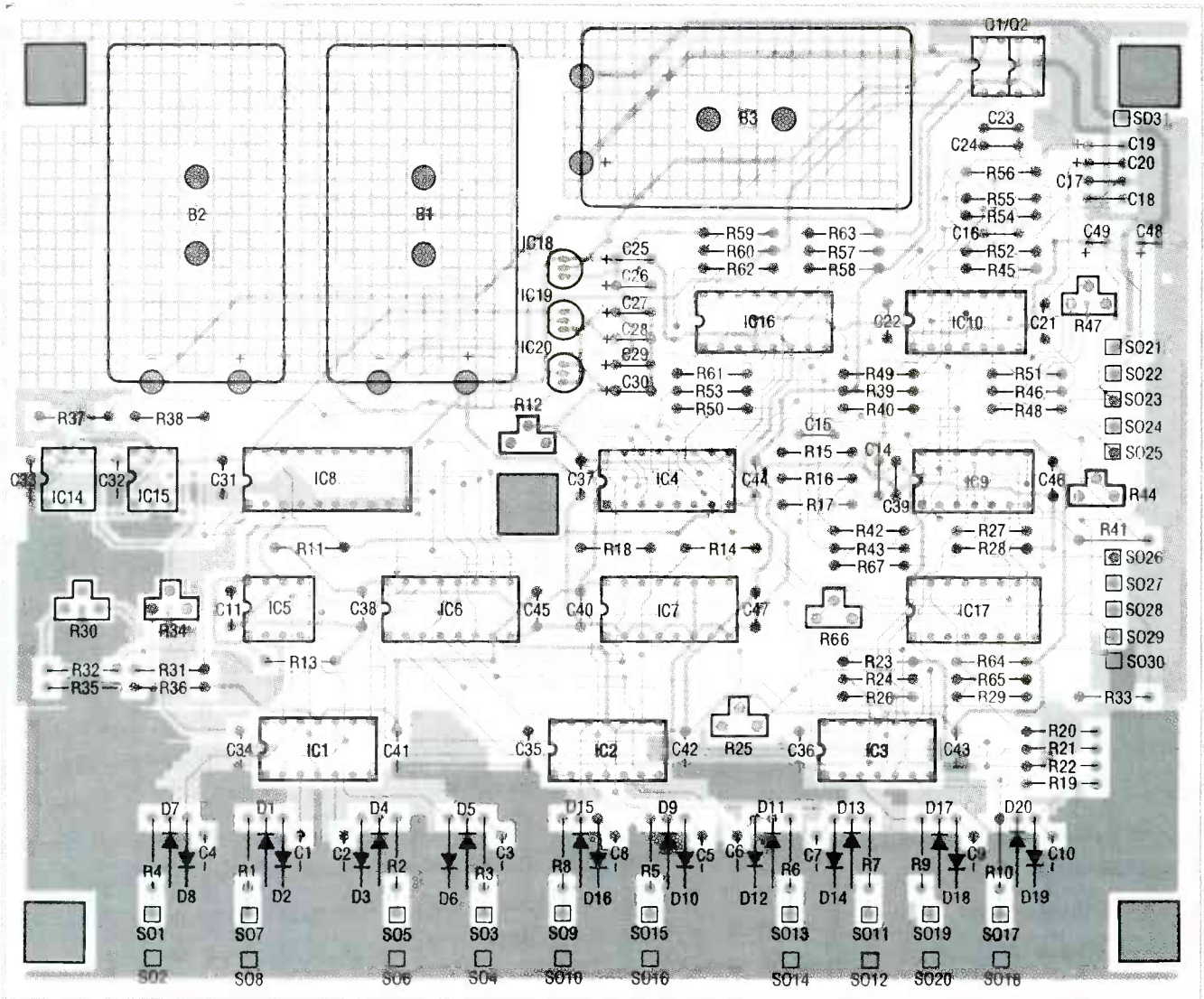

FIG. 2—MOUNT THE COMPONENTS for the front-end board as shown here. Most of the IC's are CMOS, so care must be used in handling them.

the adhesive electrodes will be placed to improve the connection and the signal, and place the elec-

trode in an area with minimal body hair. Using the alligator clips, attach the appropriate lead

to each skin electrode.

To acquire the ECG, make sure the ECG controller and your PC

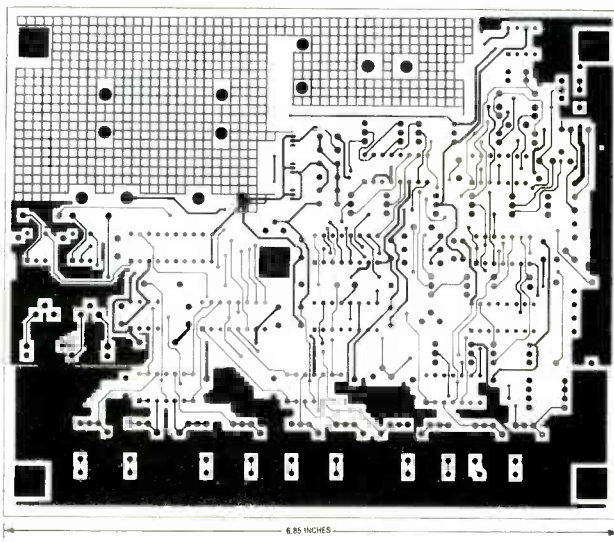

COMPONENT SIDE of the front-end board.

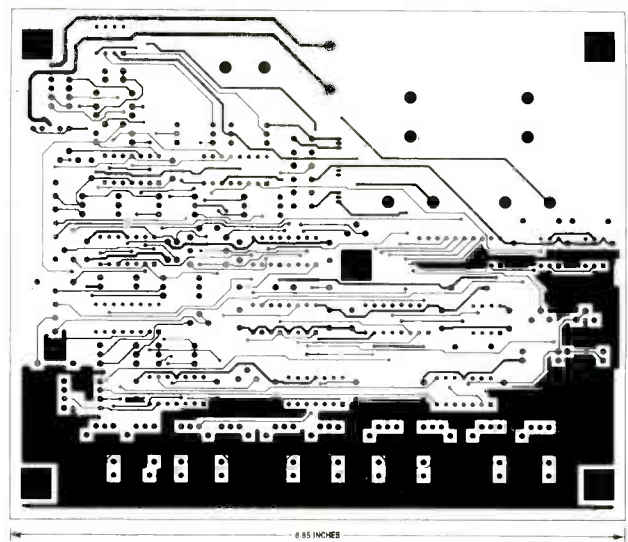

SOLDER SIDE of the front-end board.

PARTS LIST—FRONT-END

All resistors are ¼-watt, 5%, unless otherwise noted.

R1–R9, R13—20,000 ohms
R10, R24, R60, R63—30,000 ohms
R11—1800 ohms
R12, R25, R44—10,000 ohms, potentiometer
R14, R18, R26—4700 ohms
R15, R17—19,200 ohms
R16—39.2 ohms, 1%
R19—200,000 ohms
R20–R22, R41—100 ohms
R23—1500 ohms
R27—910 ohms
R28, R39, R40, R43, R55, R59, R62, R67—10,000 ohms
R29, R46, R48—15,000 ohms
R30—200,000 ohms, potentiometer
R31, R36—680,000 ohms, 1%
R32—500,000 ohms
R33—68 ohms
R34—15,000 ohms, potentiometer
R35—100 ohms
R37, R38, R43, R61—470 ohms
R42, R64—1000 ohms
R45, R51—680,000 ohms
R47—5000 ohms, potentiometer
R49—330,000 ohms
R50, R58—2200 ohms
R52, R56—1.5 megohm
R53—150 ohms
R54—150,000 ohms
R57—12,200 ohms
R65—3300 ohms
R66—1000 ohms, potentiometer

Capacitors

C1–C10—220 pF, 1000 volts, ceramic disk
C11, C19, C20—10 µF, tantalum
C12, C13—not used
C14, C23, C24—1 µF, ceramic
C15—0.001 µF, metal film
C16—39 pF, ceramic disk
C17—120 pF, ceramic disk
C18—0.01 µF, metal film
C21, C22, C31–C47—0.47 µF, ceramic disk
C25–C30—1 µF, tantalum
C48, C49—47 µF, 16 volts, electrolytic

Semiconductors

IC1–IC3, IC9, IC10—LM348 op-amp
IC4—AD625 instrumentation amplifier
IC5—TL431C precision voltage reference
IC6—4051 analog switch
IC7—4052 analog switch
IC8—Altera EP320 PAL
IC14, IC15—OP18012 optoisolator
IC16, IC17—PS2501A optoisolator
IC18, IC20—78L06AC voltage regulator
IC19—78L05AC voltage regulator
D1–D20—1N914 diode
Q1, Q2—IRFD123 N-channel HEXFET

Other components

B1–B3—9-volt battery

are connected with the RS232 cable used when you checked out the system. Load and run the data collection batch file, ECG.BAT, in your PC. Input the patient information that the program requests, terminating each

ORDERING INFORMATION

Note: The following items are available from DataBlocks, Inc., Glenwood, GA 30428, (912) 568-7101.

- **Design package including schematics, assembly instructions, and checkout- and plot-software design specifications (ECG-DP): \$27.00.**
 - **Front-end PC board, controller PC board, and design package from above (ECG-PC): \$74.00.**
 - **Complete kit of parts, including both PC boards, IC's, sockets, passive components, design package, ECG software, and checkout software (ECG-KIT): \$289.00.**
 - **Lead kit consisting of 50 feet of 29-gauge shielded cable, 10 alligator clips, heat-shrink tubing, and instructions (ECG-LD): \$53.00.**
 - **EPROM containing ECG software, ECG resident portion of checkout software (ECG-PROG): \$45.00.**
 - **Set of four programmed PAL's (ECG-PAL): \$67.00.**
 - **Case as shown with mounting hardware (ECG-CASE): \$29.00.**
 - **Package of 100 self-adhesive electrodes (ECG-EL): \$20.00.**
- Please include \$5.00 shipping and handling for design package and electrodes, \$10.00 shipping and handling for all other products. Georgia residents must add sales tax.**

answer with a carriage return. After the last response, press the reset button on the ECG to initiate data collection. Make sure the patient does not move during the collection process.

You will see a message on the PC as soon as the data collection process starts. After about 30 seconds you will see a message on the PC indicating that data is being transferred between the ECG and the PC. That is an indication that the ECG has finished collecting data. After the data has been transferred, your PC will begin processing it for display. Depending upon the speed of your PC, the graphs of the ECG will appear after a few seconds of processing. In addition to the plots shown on the CRT, each of the plots may be sent to your dot-matrix printer for a permanent record.

Now let's examine the hardware and software interactions involved with taking the ECG you just finished. First, assume the

PARTS LIST—CONTROLLER BOARD

All resistors are ¼-watt, 5%, unless otherwise noted.

R1—10 ohms
R2, R7–R10—10,000 ohms
R3–R6, R15, R16—1000 ohms
R11—7500 ohms
R12—24,000 ohms
R13—30,000 ohms
R14—10,000 ohms × 8, SIP
Capacitors
C1–C22, C25, C26, C28, C29, C33, C34, C42—0.47 µF, ceramic disk
C23, C24—22 pF, ceramic disk
C27, C30—0.001 µF, metal film
C31—220 pF, ceramic disk
C32—10 µF, 10 volts, electrolytic
C35, C38, C39—10 µF, 10 volts, tantalum
C36, C37, C40, C41—1 µF, 10 volts, tantalum

Semiconductors

IC1—Z80 CPU
IC2–IC5, IC12—74HC245 bus transceiver
IC6, IC8—Altera EP320 PAL
IC7—Altera EP600 PAL
IC9—27C256 EPROM
IC10, IC11—55257 static RAM
IC13—74HC688 equality comparator
IC14—74HC138 1-of-8 decoder
IC15—82C52 UART
IC16, IC17—74HC573 octal latch
IC18—74HC74 dual D flip-flop
IC19—MC145406 RS232 transceiver
IC20—AD0829 A/D converter
IC21, IC22—DAC0830 D/A converter
IC23, IC24—NE5532A op-amp
IC25—74HC14 hex Schmitt inverter
IC26—74HC00 quad NAND gate
IC27—PS2501A-2 optoisolator
IC28, IC31—not used
IC29—ICL7660 DC-DC converter
IC30—78L06AC voltage regulator
IC32—7805 voltage regulator
D1–D4—1N914 diode
D5—5.1-volt Zener diode
D6—6-volt Zener diode
Q1—IRFZ10 N-channel MOSFET
Other components
XTAL1—2.4576 MHz crystal
XTAL2—8.00 MHz oscillator
S1—SPDT momentary contact switch
SO1—DB25 connector

RS232 ports between the ECG and the PC have been connected, the PC has been booted, and the ECG batch file run. As soon as the ECG reset button is pressed, the microprocessor in the ECG controller boots up and enters a wait loop, waiting for the PC to announce to the ECG that it is time to begin taking data. After the initialization prompts for patient information, and the name of the file that will be used to store the ECG data has been entered through the PC keyboard, the PC

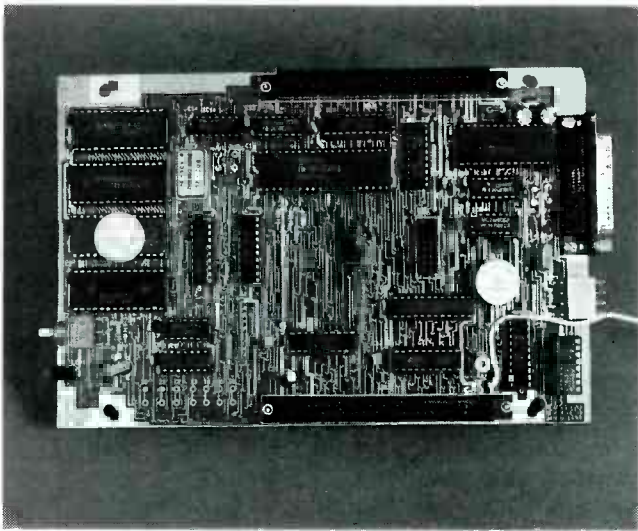

FIG. 3—THE FINISHED CONTROLLER BOARD will look similar to this one, although this is an early prototype board. Inspect the finished boards thoroughly before beginning the system check-out.

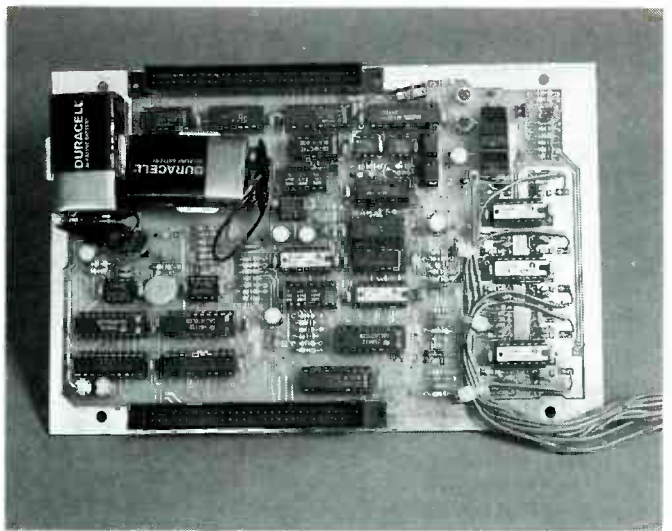

FIG. 4—THE FINISHED FRONT-END BOARD. This, too, is an early prototype, so your board won't look exactly like this one. Do not wire the two boards together until you are told to do so.

software transmits a control character to the ECG that causes it to start the ECG data-collection process.

The ECG turns both batteries on and enters a calibration routine. The first part of the routine determines whether the batteries are charged. That is accomplished by digitizing the output of IC10-d in the front-end electronics with the differential inputs to the instrumentation amplifier, both connected to ground through IC7. If the batteries are good, the voltage measured will be the 2.5-volt offset from the differential amplifier. If both batteries are not fully charged, the voltage from the divider formed from R31, R34, and R36 will change, causing the output of IC10-d to change from the expected 2.5 volts. If the batteries are not good, the ECG outputs a "low battery" message to the PC and stops. If the batteries are good, the channel calibration routine is entered.

The channel calibration routine determines the appropriate channel offset for each of the nine input channels. That is accomplished by sequentially connecting each of the input channels to the positive input of the differential amplifier and comparing its voltage to that of the Wilson electrode connected to the negative input of the differential amplifier. If those two voltages are equal, the digitized output of the differential amplifier will be its offset voltage, 2.5

volts. If the input lead is not equal to the Wilson electrode, a bias is added to the channel by incrementing the output of either IC21 or IC22 in the appropriate direction; IC21 is used for coarse changes, while IC22 is used for smaller increments. That change is added to the output of the other D/A converter at the summing junction of IC24-b and passed to the front-end board.

On the front-end board, the change goes through the optical isolator IC17-a and op-amp IC9-c to the summing junction of IC3-c, where it adds with the input channel being measured. After an appropriate delay to let the voltages in the loop settle, the output of the differential amplifier is sampled again. The process is continued until the difference between the input channel and the Wilson electrode voltage is within acceptable limits, at which time the system sequences to the next channel. The digital values required to adjust the analog output of IC21 and IC22 to bring the channel biases within acceptable limits are stored in the software to be used during the data-acquisition process.

The data-acquisition routine is entered immediately after the last channel bias has been determined. This routine digitizes the difference between each input lead and the Wilson electrode, in sequence, and stores the sample in memory. Prior to digitizing the

sample, the channel bias values for the channel being sampled, determined during the calibration sequence, are retrieved from the software and placed in the D/A converters, as previously described. Each channel is sampled as rapidly as the processing and loop settling time will permit. The software then enters a wait period before sampling the next data set to achieve a 400-sample-per-second rate on each of the nine channels. Two thousand samples are obtained from each channel and placed in memory for subsequent transfer to the PC for display.

At the completion of the data-acquisition phase, the ECG controller turns the batteries B1 and B2 off and signals the PC that the data is available for transfer. When the PC detects that it acknowledges the message and starts its transfer routine. The ECG also sets up a transfer routine and the data is passed from the ECG to the PC. At the conclusion of the transfer, the ECG powers itself down, waiting for the PC to signal that it is time to acquire another ECG. The PC begins to process the data it just received during the transfer.

The data transferred to the PC must be processed before it can be displayed as one of the twelve standard ECG leads. Remember that the digitized information is the difference between the input channel and the Wilson electrode. The first six ECG leads, however, are combinations of in-

put channels compared with one or more other input channels. For example, consider the standard ECG lead I. This lead is defined as the electrical activity from the heart measured on the left arm with respect to the right arm. Let S1 designate a sample from the right arm with respect to the Wilson electrode, and S2 designate a sample from the left arm with respect to the Wilson electrode. In other words:

$$S1 = RA - W$$

$$S2 = LA - W$$

Now,

$$I = LA - RA = (S2 + W) - (S1 + W)$$

$$I = S2 - S1$$

so that the PC must subtract Sample 1 from Sample 2 to get lead I. In an analogous manner leads II and III are derived from their definitions as:

$$II = S2 - S3$$

$$III = S1 - S3$$

The augmented leads are somewhat more complicated to derive from the samples. Recall that an augmented lead is defined as the electrical activity on one of the three input leads with respect to the other two leads. For example:

$$AVR = RA - (LA + LF)$$

Now,

$$S1 = RA - W$$

$$S2 = LA - W$$

$$S3 = LF - W$$

so that

$$AVR = S1 - S2 - S3 - W$$

Recall that W, the Wilson electrode, is the sum of RA, LA and LF (W = RA + LA + LF) so that:

$$S1 = RA - W = RA - RA - LA - LF = -LA - LF$$

$$S2 = LA - W = LA - RA - LA - LF = -RA - LF$$

$$S3 = LF - W = LF - RA - LA - LF = -RA - LA$$

Adding the samples:

$$S1 + S2 + S3 = -2RA - 2LA - 2LF = -2W$$

or

$$W = -(S1 + S2 + S3)/2$$

and

$$AVR = S1 - S2 - S3 - W$$

$$= S1 - S2 - S3 + (S1 + S2 + S3)/2$$

$$AVR = S1 + (S1 - S2 - S3)/2$$

Using the same arithmetic, it can be shown that

$$AVL = S2 + (S2 - S1 - S3)/2$$

$$AVF = S3 + (S3 - S2 - S1)/2$$

The chest leads V1 through V6 are defined as simply the electrical activity on the lead with respect to the Wilson electrode.

The processed data is stored on your disk drive under the file

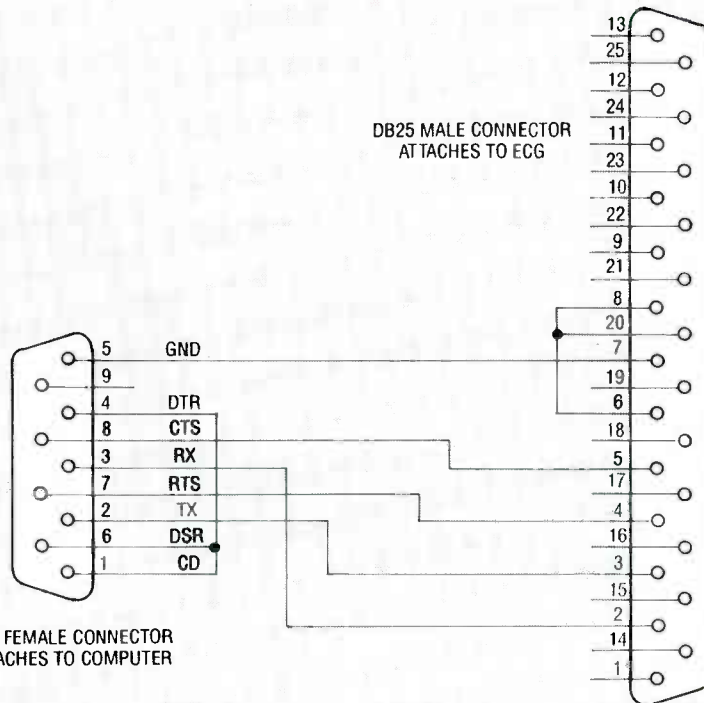

FIG. 5—THE RS232 CABLE between your PC and the DB25 connector should be wired as shown here if your PC has a 9-pin communications port.

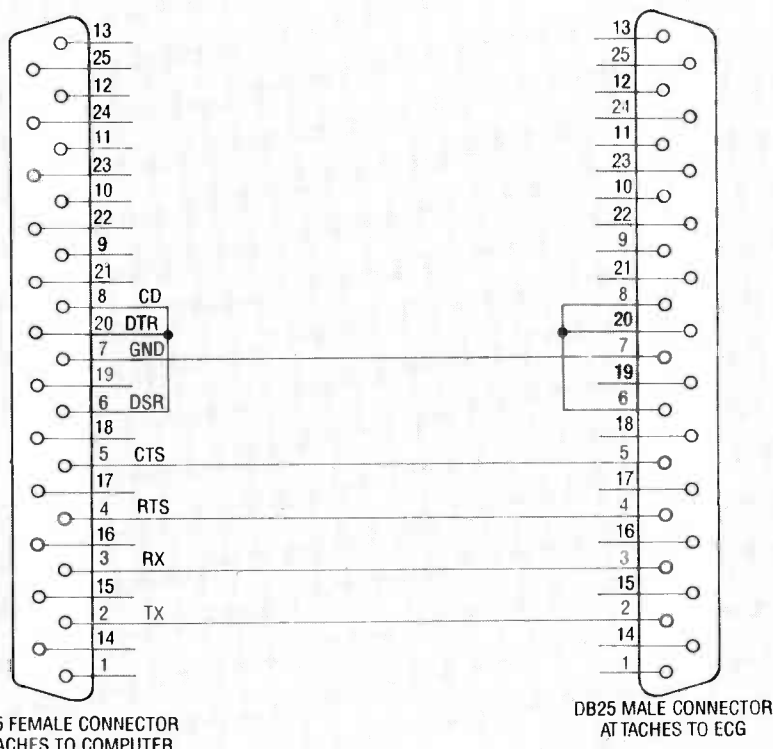

FIG. 6—IF YOUR PC HAS A 25-PIN communications port, wire the the RS232 cable between your PC and the DB25 connector as shown here.

name you entered. In addition, three traces are plotted on the CRT with each trace broken into four parts. The traces are segmented as follows:

- Trace 1 = Lead I, AVL, V1, V4
- Trace 2 = Lead II, AVR, V2, V5

Trace 3 = Lead III, AVF, V3, V6

You should have enough information now to use the ECG. However, if you're not a doctor, don't think of yourself as one—and be sure to see a medical doctor if you suspect any health problems. R-E

Build this powerful serial-bus analyzer for a fraction of the cost of commercial units—and learn about the ever-popular 68705 microcontroller in the process.



RS-232 TERMINAL/MONITOR

STEVEN AVRITCH

HAVE YOU EVER BEEN FRUSTRATED by a problem with an RS-232 line? Inexpensive breakout boxes with five or six LED's suffice for solving simple problems, but they don't provide enough information to debug the serious kind. On the other hand, full-featured serial bus analyzers (SBA's) give you all the debugging information you need, but can cost close to \$1000.

However, you don't really have to spend that much. Now you can build a powerful RS-232 monitor that does most of what the expensive SBA's do, yet doesn't cost much more than a quality breakout box. In addition, this project can also be used as a portable, battery-operated terminal. Features are summarized in Table 1.

Hardware design

The heart of the project is Motorola's MC68HC705C8 single-IC microcontroller, a 40-pin DIP containing built-in PROM, RAM, serial and parallel I/O ports, timer, and clock.

The monitor requires two serial receivers: one for the TXD line and one for the RXD line. Because the microcontroller has only one

built-in serial port, a second one has been implemented in software. However, the second port still requires a ± 12 -volt RS-232 interface. The schematic is shown in Fig. 1, and the wiring diagram is shown in Fig. 2.

A Maxim MAX232 RS-232 transceiver (IC2) provides the transmission portion of the interface; it converts TTL signals from the microcontroller to RS-232 levels. Unlike most RS-232 transceivers, which require separate +12- and -12-volt power supplies, the MAX232 has built-in charge pumps that generate the required voltages from a single 5-volt supply. A standard 1489 device (IC4) converts incoming ± 12 -volt signals to TTL levels.

Switch S1 is a DPDT unit that selects terminal or monitor mode. In terminal mode the CPU controls the logic levels of both lines. However, in monitor mode, all lines from the primary port (J1) are directly connected to the secondary port (J2), in which case all signals pass straight through and the device simply monitors TXD and DTR.

Other notable components include XTAL1 and the keyboard. The crystal is a standard, readily available device; it must have a

frequency of exactly 2.4576 MHz in order to generate the correct baud rates. The keyboard is a surplus unit from an old TI-99/4 personal computer; the keyboard is inexpensive and readily available through many suppliers.

A beeper may be connected to pin 19 (port B7) of the microcontroller. The beeper will sound whenever the monitor detects a bell character (ASCII 07 or Cntl-G). The beeper must be TTL-compatible (meaning that it must be powered from a 5-volt supply and draw less than 3 mA).

The low power consumption of the microcontroller allows it to operate over a wide range of input voltages (8–15 volts DC): IC3 provides voltage regulation. The output of IC3 is 6 volts; diode D2 drops voltage even further, to about 5.3 volts. D1 provides reverse-polarity input protection.

Operating modes

The RS-232 Terminal/Monitor has four basic modes of operation, as shown in Table 2. You use the keyboard to select mode, as well as a variety of operational parameters. In use, you must place S1 in the Terminal position when in terminal mode, and in the Monitor position when in any of the three display modes.

The terminal-mode display is similar to a dumb ASCII terminal, except that the display is limited to forty characters by two lines. The CPU converts keyboard characters to ASCII, then transmits them over the serial link. Conversely, received characters are displayed in ASCII on the LCD screen.

The Display Bits mode continuously displays the status of the six primary RS-232 signals, as shown in Fig. 3-a. The Display ASCII mode shows activity on the TXD and RXD lines. TXD data appears in ASCII on line one and RXD data on line two (Fig. 3-b). The Display Hex mode is similar, except that each character appears in hexadecimal format, as shown in Fig. 3-c. (A period "." indicates that the line was inactive when a character was received on the other line.)

TABLE 1—FEATURES

- 40-character × 2-line LCD display
- Full keyboard
- Selectable baud rate (300 –19,200)
- Selectable protocol (number of data and parity bits)
- Programmable scroll rate
- Recall of last two lines displayed
- 8- to 15-volt DC power (9V battery is perfect)
- CMOS design for low current drain and long battery life

TABLE 2—MODES OF OPERATION

| | |
|---------------|---|
| Terminal | The unit acts as a simple RS-232 "dumb" terminal. The unit can be connected anywhere a dumb terminal is needed. |
| Display Bits | Displays status (high or low) of the six primary RS-232 lines (TXD, RXD, RTS, CTS, DSR, DTR). |
| Display ASCII | Displays TXD (line 1) and RXD (line 2) activity in ASCII format. |
| Display Hex | Like Display ASCII mode except hexadecimal display. |

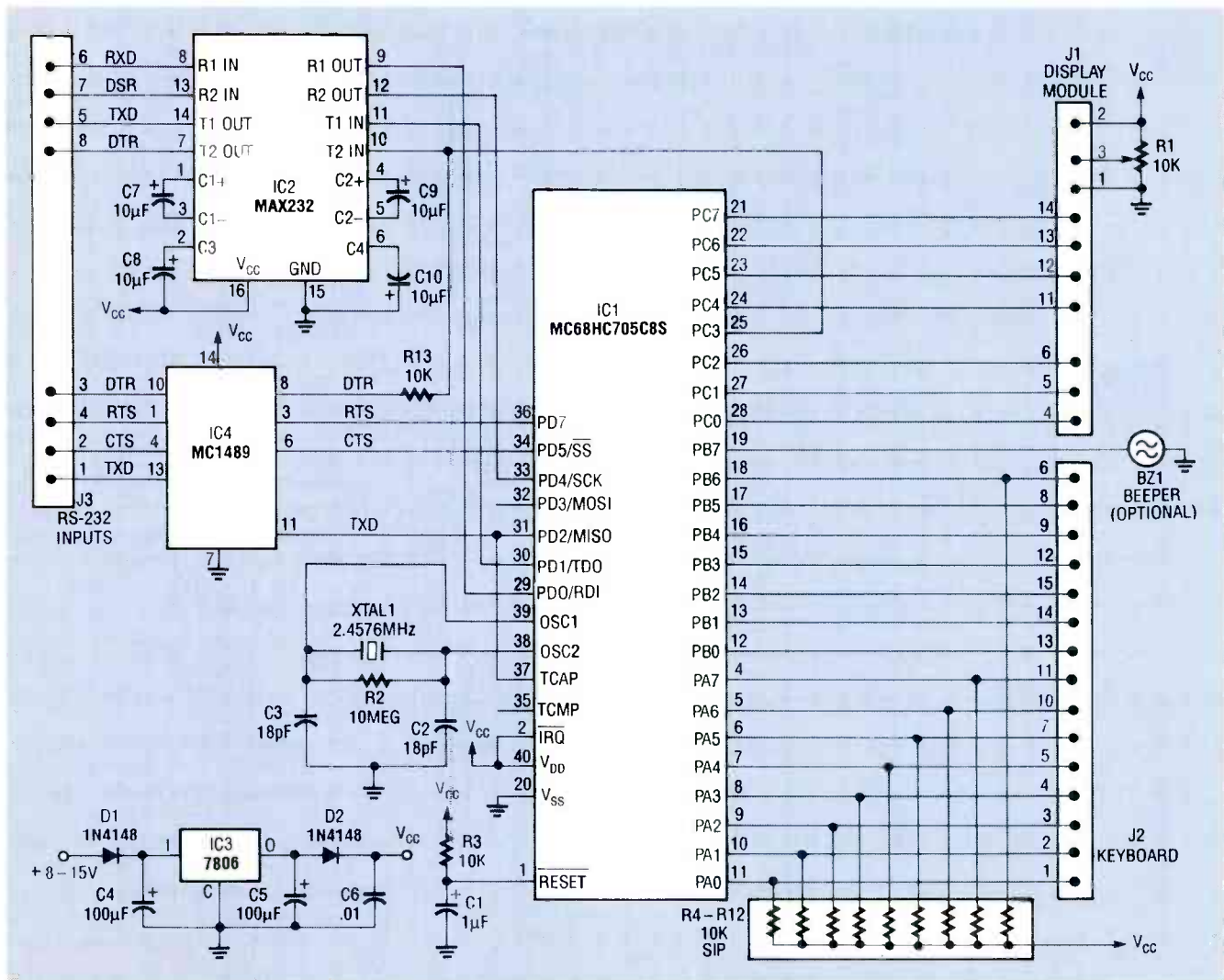

FIG. 1—SCHEMATIC OF THE TERMINAL MONITOR. The keyboard is a surplus unit from a TI 99/4 computer.

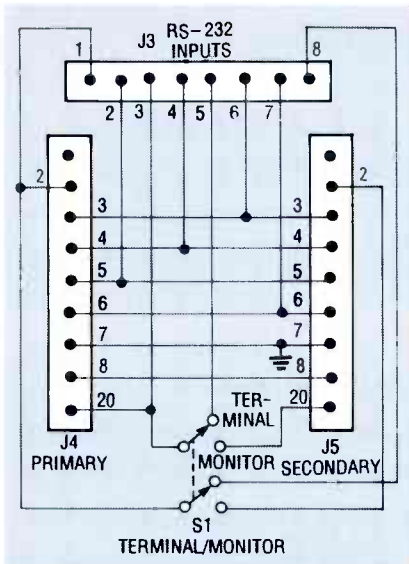

FIG. 2—WIRING DIAGRAM for the terminal/monitor. Connectors J4 and J5 are standard DB-25 males.

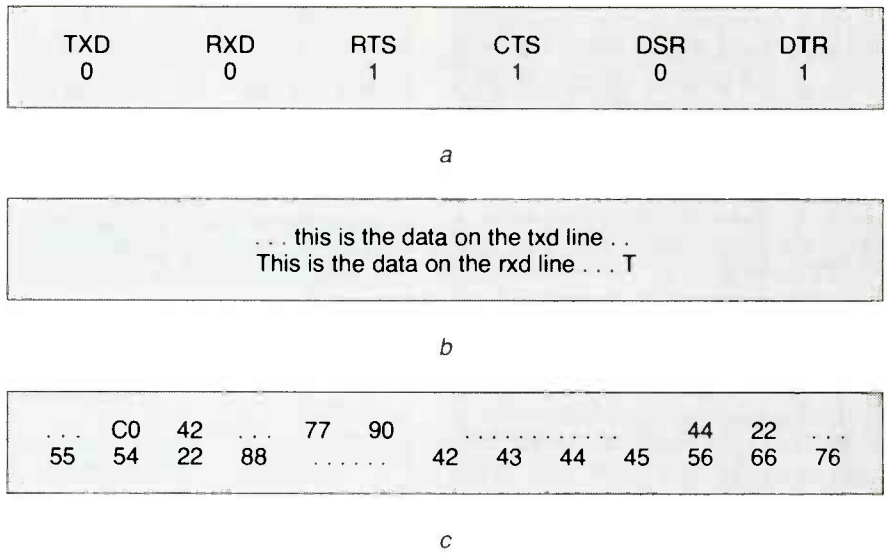

FIG. 3—DISPLAY SAMPLES. The Display Bits mode is shown in *a*; the ASCII mode is shown in *b*, with TXD on top and RXD on the bottom; and the hex mode is shown in *c*, again with TXD over RXD.

TABLE 3—FUNCTION REQUESTS

| 1st | Description | 2nd | Description |
|-----|-----------------------------|-----|---------------|
| M | Select mode | 1 | Terminal |
| | | 2 | Display Bits |
| | | 3 | Display ASCII |
| | | 4 | Display Hex |
| 0 | Display current parameters | | |
| 1 | Set baud rate | 0 | 19,200 |
| | | 1 | 9600 |
| | | 2 | 4800 |
| | | 3 | 2400 |
| | | 4 | 1200 |
| | | 5 | 600 |
| | | 6 | 300 |
| 2 | Set Protocol | 0 | 8N1 |
| | | 1 | 7N1 |
| | | 2 | 7E1 |
| 3 | Set scroll rate delay | 0-9 | 0=off, 9=max |
| 4 | Toggle scroll/two-line mode | | |
| 5 | Enable/disable linefeed | | |
| 6 | Recall last two lines | | |
| L | Toggle local/online modes | | |
| H | Display help information | | |

During operation in ASCII or hex mode, you can press Cntl-S to halt input temporarily and read what is displayed. Then simply press Cntl-Q when you're ready to continue.

The monitor has several keys that can produce more than one symbol. For example, the question mark symbol is located on the front of the "I" key. To produce a question mark, press I and the FCTN key simultaneously.

Function requests

You can change several operating characteristics by pressing special key combinations, as shown in Table 3. To set a given parameter, press FCTN and the key shown in column one of the table.

Select Mode. Press FCTN-M, then press 1-4 to select mode.

Current Parameters. Press FCTN-0 to view current settings for mode (terminal), baud rate (1200), protocol (7E1), scroll rate (0), scroll mode, linefeed status (enabled), and on/off-line status (on-line). (Default values shown in parentheses.)

Set Baud Rate. Press FCTN-1 to set baud rate. The monitor runs from 300 to 19,200 bits/sec, but the maximum rate in ASCII and Hex Display modes is 9600.

Protocol. Press FCTN-2 to define the number of data bits (7, 8), parity (Even, Odd, None), and stop bits (1, 2) in each byte sent or received. The terminal currently supports three popular formats: 8N1, 7O1, and 7E1.

PARTS LIST

All resistors are ¼-watt, 5%

R1—10,000 ohms, PC-mount potentiometer

R2—10 megohms

R3, R13—10,000 ohms

R4—R12—10,000 ohms, SIP

Capacitors

C1—1 µF, 16 volts, radial electrolytic

C2, C3—18 pF, ceramic disk

C4, C5—100 µF, 25 volts, axial electrolytic

C6—0.01 µF, ceramic disk

C7—C10—10 µF, 16 volts, radial electrolytic

Semiconductors

IC1—MC68HC705C8 CMOS microcontroller

IC2—MAX232 5-volt RS-232 transceiver

IC3—MC7806CT 6-volt regulator, TO-220 case

IC4—MC1489A RS-232 receiver

D1, D2—1N4148 switching diode

Other Components

XTAL1—2.4576 MHz

J1—16-pin 0.1" dual-row header

J2—30-pin 0.1" dual-row header

J3—8-pin 0.1" dual-row header

J4, J5—DB25 connector, male

S1—DPDT switch

BZ1—TTL-compatible beeper (Radio Shack #273-65 or equivalent)

Display—40 × 2 line LCD display module (Hitachi LM018L or equivalent)

Keyboard—Surplus TI-99/4 (48-key, 15-pin connector)

Note: The following are available from Simple Design Implementations, P.O. Box 9303, Forestville, CT 06010. (203) 582-8526:

- Complete kit including everything in parts list, IC sockets, PC board, instructions, and schematic—\$75 + \$5 S/H

- Preprogrammed MC68HC705C8, instructions, and schematic—\$28.00 + 2.50 S/H

- Software on 5¼-inch IBM-compatible floppy disk—\$15.00 + \$2.50 S/H

- PC board only—\$13 + \$2 S/H. CT residents please add 8% sales tax.

Scroll Rate Delay. Press FCTN-3 to vary scroll rate. Data may scroll by faster than you can read it; variable scroll rate allows you to reduce scrolling speed by disabling the DTR line for a while after receiving each carriage return. Scroll-rate delay may vary

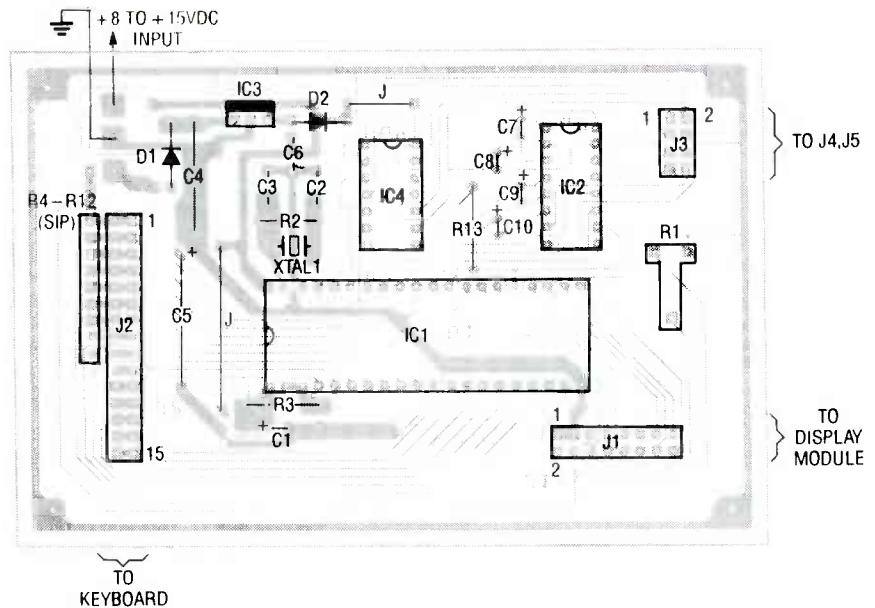

FIG. 4—PARTS PLACEMENT DIAGRAM. Mount all parts on the board as shown here.

from 0 (no delay) to 9 (maximum delay—about three seconds). The device connected to the monitor must recognize DTR and stop sending data when it is low. This works only in terminal mode.

Two-line/Scroll Mode. Press FCTN-4 to switch between the continuous scrolling and two-line modes. In scroll mode the terminal scrolls incoming data at the scroll rate set by FCTN-3. In two-line mode the terminal stops the display every time both display lines are filled. You must then press the space bar to continue. This feature works only in terminal mode.

Enable/Disable LF. Press FCTN-5 to switch between responding to and ignoring incoming linefeed characters. Some terminals, modems, and host systems issue a linefeed (LF) in addition to a carriage return (CR) at the end of every line. Extra linefeeds cause a blank line to be displayed on the screen, hence make it difficult to read. Tell the monitor to ignore extra linefeeds by selecting the LF Disabled mode. This feature works only in terminal mode.

Recall Last Two Lines. Press FCTN-6 to review the last two lines that scrolled off the screen. Press any key to return to the current two lines. Note that communication is disabled via the DTR line when displaying the last two lines. This feature works only in terminal mode.

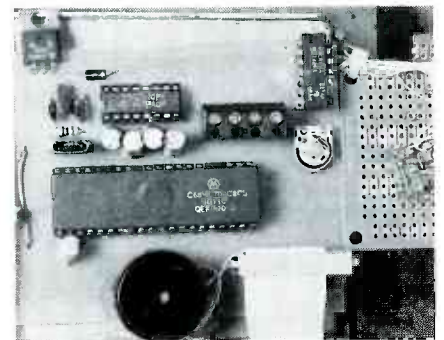

FIG. 5—THE AUTHOR'S PROTOTYPE. After applying power to the unit a brief sign-on message should appear. The display contrast can be adjusted via potentiometer R1.

Help. Press FCTN-H to view a brief summary of the function associated with each. You are able to view this screen from any operating mode.

Local/On-line Mode. Press FCTN-L to switch between local and on-line modes. In local mode, RS-232 communications are disabled; characters typed on the keyboard appear on the LCD display immediately. In on-line mode, RS-232 communications are enabled. Characters typed on the keyboard are transmitted over the serial link and are not displayed until they are echoed by the host system. This feature works only when used in the terminal mode.

Interfacing

To use the device as a dumb

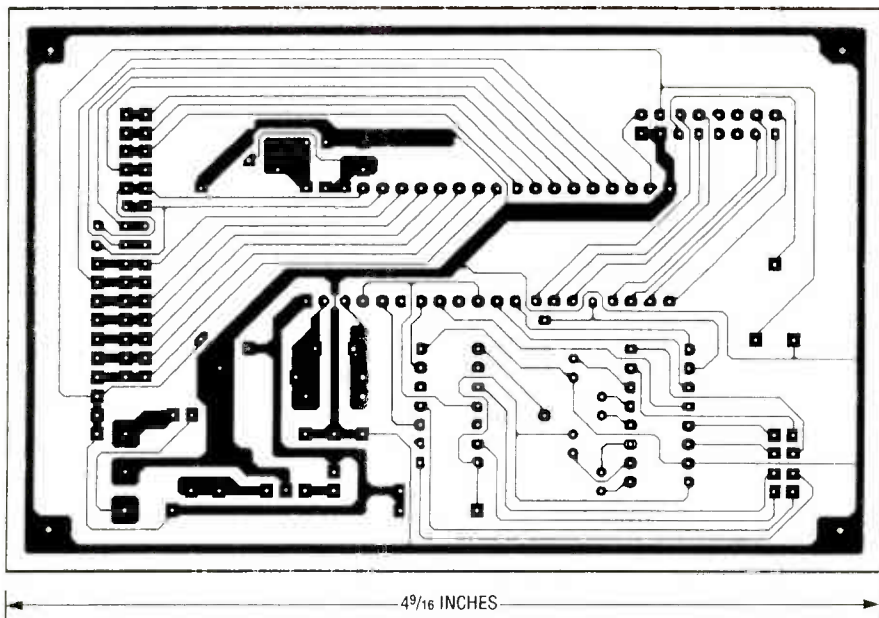

USE THIS FOIL PATTERN if you would like to etch your own board.

TABLE 4—TERMINAL VOLTAGES

| Pin | Description |
|-----|---|
| 2 | - 7 to - 12 VDC |
| 3 | 0 VDC |
| 7 | Check for continuity to ground |
| 8 | 0 VDC |
| 20 | Press Cntl-S and Cntl-Q to toggle between + 7 to + 12 and - 7 to - 12 VDC |

ASCII terminal, be sure to place switch S1 in Terminal position, then make sure that the unit is operating in terminal mode, and then enter the correct operating characteristics (baud rate, protocol, etc.). Last, connect the unit to the host system via a standard 25-conductor cable. If the unit doesn't seem to work, you may need to reverse pins 2 and 3 using a null-modem cable or adapter.

To use the device as a monitor, connect it in series with the two devices (host and terminal, host and modem, etc.), place S1 in Monitor position, and choose one of the terminal modes. Then all you have to do is set protocol, baud rate, etc.

Software

The MC68HC705C8 software consists of an assembly-language

program; unfortunately the listing is too long for publication. The program must be assembled and the resultant object code must be burned into the microcontroller's built-in EPROM. If you don't have facilities for assembling the program and burning it in, don't worry—you can purchase a pre-programmed MC68HC705C8 from the author; take a look in the parts list for details.

If you wish to modify the source code (or maybe just look it over), you can download it from the RE-BBS (516-293-2283, 1200/2400, 8N1) as a file called SMART232.SRC, or you can otherwise order it directly from the author.

Construction

You can build this project using wire-wrap or a PC board. A foil pattern is provided if you'd like to make your own board; you can also purchase a ready-to-use board from the source mentioned in the parts list if you don't want to make your own.

Using Fig. 4 as a guide, assemble the PC board starting with the passive components. Then mount sockets for the IC's, connectors J1-J3, and don't forget the two jumpers. Check your work carefully, correct any mistakes, and then insert the IC's into the sockets. Connect the cables from the keyboard and LCD module. Then make the connec-

tions between J1, J2, and the PC board. A photograph of the author's prototype unit is shown in Fig. 5.

After verifying all wiring, apply power to the unit; a brief sign-on message should appear on the display. Adjust Contrast potentiometer R1 for best effect. Now set switch S1 to the appropriate position, and set the desired mode and operating characteristics using the Function keys. That's all there is to it!

Troubleshooting hints

If the sign-on message does not appear on the display on power-up, the most likely cause of the problem is a wiring error. The error is probably in the power or ground lines (IC1, pins 20 and 40), the oscillator lines (IC1, pins 38 and 39), the reset line (IC1, pin 1) or the display interface lines (pins 1-6 and 11-14 of the LCD display).

If the terminal comes up with the initialization message but does not seem to communicate, check the keyboard and RS-232 driver. Check the keyboard by pressing FCTN-0 to display system parameters. If they don't appear, check the keyboard wiring. If the terminal does display system parameters, press FCTN-L to put the terminal in local mode and then test the keyboard by pressing every key and checking for the correct letter on the display. If the keyboard checks out, the problem is probably located somewhere in the RS-232 driver, in the cabling, or in the RS-232 line itself.

Remove the connector from the terminal's primary port, set the DPDT switch to terminal mode, and check the voltages on the terminal's primary port. They should be close to the values shown in Table 4. If any of the values do not agree with Table 4, check the wiring of the RS-232 driver (IC2).

Wrapping up

The author housed his prototype in a custom-built enclosure that resembles a miniature RS-232 terminal. You could use an off-the-shelf metal or plastic case just as well. Just keep in mind that, however you package it, this terminal/monitor is a useful and fun project. R-E

SPEAKER PROTECTOR

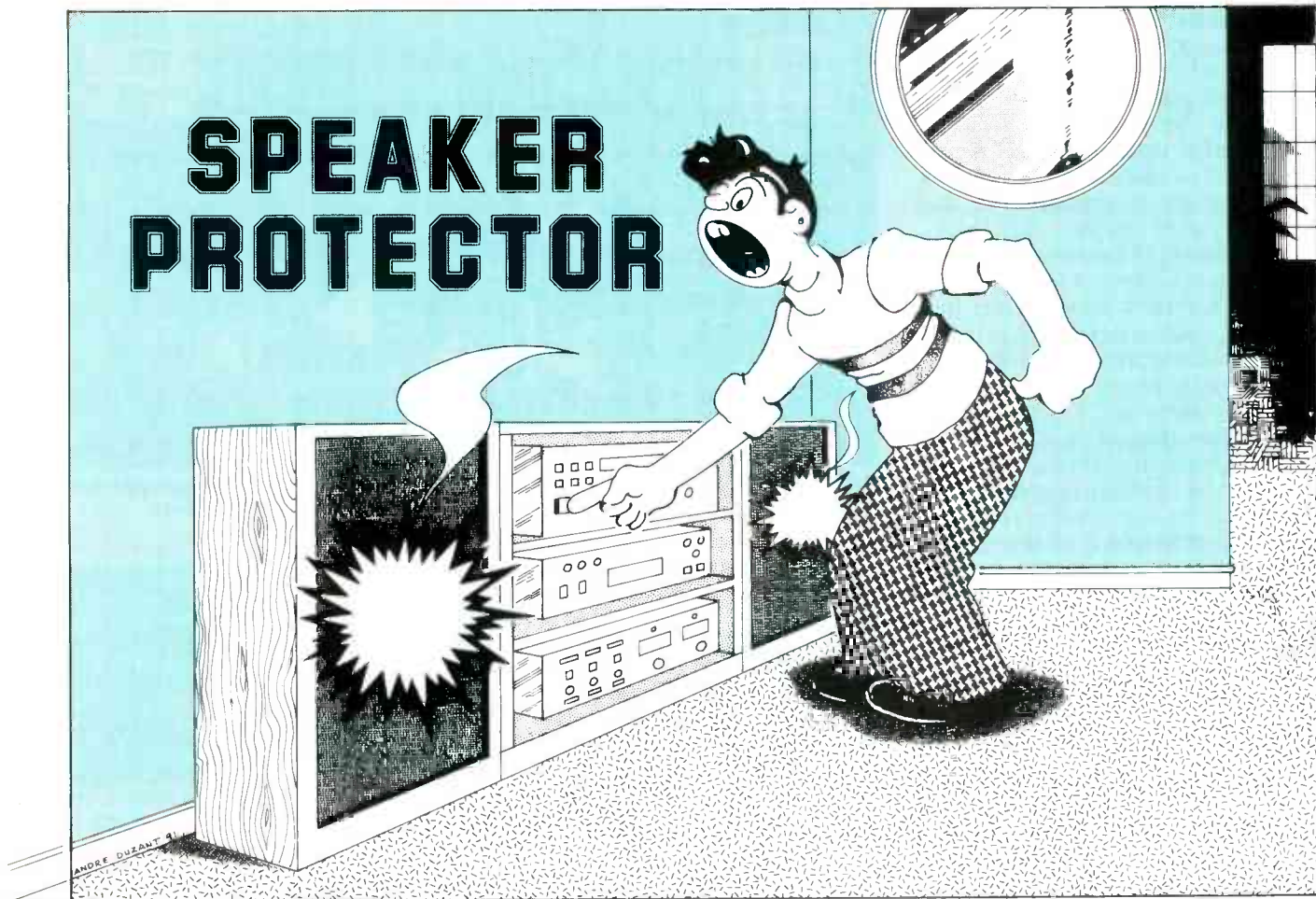

This simple circuit will protect your stereo speakers in the event of amplifier failure.

IF YOU'VE HAD FIRST-HAND EXPERIENCE with damaged speakers due to a faulty amplifier, or if you value your speakers enough to want to prevent such damage in the first place, then the circuit described in this article is for you. The circuit will protect speakers against an amplifier that may have a shorted output stage and thus deliver excessive DC voltages that will easily ruin a speaker coil. If your amplifier has a sound-processing delay after the power has been turned on, a functionally similar circuit is already built in. This article will give you a basic idea of the delay's function and how it works to protect the speakers. The circuit is designed for solid-state amplifiers and is not necessary for tube-type amplifiers that have output transformers. (An output transformer blocks any DC from the speaker terminals.)

MARK A. VAUGHT

The circuit is very versatile and can be customized for many different applications. Plans for home stereo, automotive, and commercial PA/guitar amplifier applications are included.

The most common cause of speaker failure is catastrophic amplifier failure. That's in contrast to the conception that the speaker has been overdriven by an amp that's operating normally. Most often the speaker power level has been chosen to match the driving amplifier. Semiconductors designed to handle high current, such as bipolar power transistors and MOSFET's, usually short when they blow out. Often these devices are connected directly to an amplifier's DC power-supply rails or through a small amount of resistance that can't effectively lim-

it the current when the short occurs.

The DC level of an amplifier's power supply is designed to accommodate the peak power levels that occur when the amp is driving the speaker at full power. A 100-watt amplifier has power-supply rails of at least 40 volts. Under normal operating conditions, that level would never be applied to the speaker coil for more than a few seconds. However, if an output device in the amp shorts, the DC is applied to the speaker continuously. In the case of a 100-watt amplifier, that causes a power dissipation of:

$$P_D = (40V/\text{speaker resistance})40V$$

Speaker resistance is usually one to two ohms less than the AC impedance. If a blown amplifier is connected to a 100-watt speaker with a 7-ohm DC resistance, the power being dissipated is:

$$P_D = (40V/7\Omega)40V \\ = 228 \text{ watts}$$

The speaker will be able to dissipate that power for only a couple of seconds before the coil is damaged due to excessive heat.

When the protector circuit senses a DC voltage on the speaker line, it activates a relay whose contacts are in series with the speaker; after two seconds the relay disconnects the speaker until the DC is removed. A fuse is inadequate for this application because the value needed to protect the speaker against DC will blow out at peak power levels during normal operation. Conversely, a fuse value chosen to allow peak power operating levels will not protect the speaker against a DC voltage. The protector circuit allows peaks to occur in the power level and also protects the speaker against DC. It should be used in conjunction with a fuse value calculated from peak power levels. The fuse should be placed as close to the amplifier as possible, if not in the same chassis, and is therefore not shown in the protector circuit's schematic.

Circuitry

The protector circuit's schematic is shown in Fig. 1 and the power supply is shown in Fig. 2. Up to four individual protector circuits can be powered from one supply, although most applications will require only one or two circuits per chassis. The optional 9-volt DC output jack can be used to power a footpedal or fuzzbox, eliminating the need for a DC wall transformer when the circuit is used to protect guitar-amplifier speakers. The power supply can be modified for different applications, and we'll talk about them later.

Referring to Fig. 1, the voltage-divider resistors R3–R6 are used to bias the positive and negative inputs of the window comparator formed by IC1-a and IC1-b. The inputs are biased at plus and minus 3 volts. The voltage divider also provides a 9-volt reference for the negative input of comparator IC1-c.

Resistors R1 and R2 form an input voltage divider fed from the speaker terminals of an audio amplifier. The input divider is referenced to analog ground, and the output of the divider is connected to the negative and positive inputs of the window

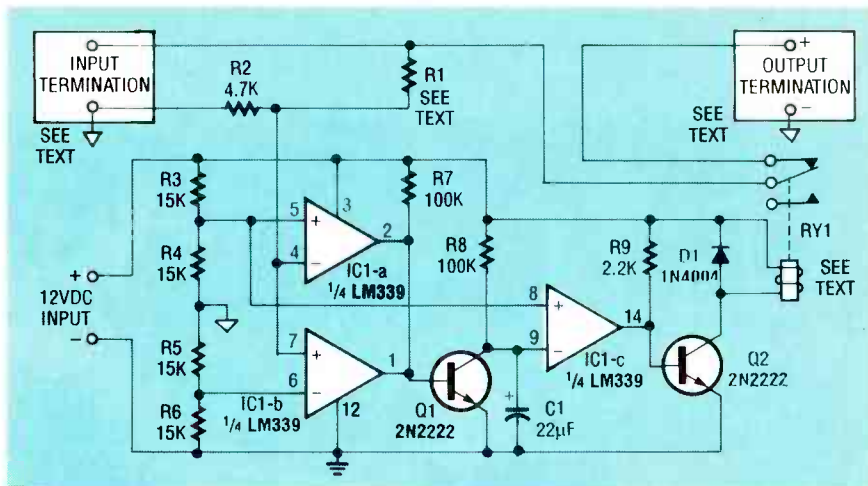

FIG. 1—IF AN AMPLIFIER OUTPUT SHORTS, this circuit will protect your speakers from the harmful DC voltage that will be present at the amplifier's speaker outputs.

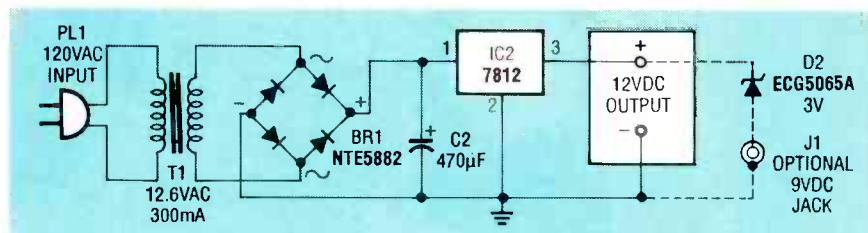

FIG. 2—THE POWER SUPPLY can be used for up to four individual protector circuits. The optional 9-volt DC output jack can be used to power an electric-guitar footpedal or fuzzbox.

comparator (IC1-a and IC1-b). The outputs of IC1-a and IC1-b are open-collector stages, wired together, and pulled high through R7. That forms a wired-OR function and completes the window comparator. When the output of the R1-R2 voltage divider exceeds the reference levels set by R4 and R5, the output of the window comparator goes low and removes the bias from Q1. The input voltage at which that happens is determined by the value of R1. The formulas for calculating R1 are presented later in this article. Transistor Q1 is turned off while the output of the window comparator is low, thus allowing timing-capacitor C1 to begin charging through R8.

Under normal input conditions (an AC audio signal), the output of the window comparator will return to a high level when the input returns to the plus and minus 3-volt range. That biases Q1 into conduction and immediately discharges C1. If a DC signal large enough to trigger the window comparator is present on the input, then Q1 will remain in its off state and C1 will charge until it reaches 9 volts

with reference to the power-supply ground. When C1 reaches 9 volts it triggers comparator IC1-c causing its output to go high and bias Q2 into conduction via R9. When turned on, Q2 grounds one end of relay RY1 thereby activating it and disconnecting the audio passing through its contacts from the speaker. The relay contacts will remain open until the DC input is removed from the protector circuit. Diode D1 protects Q2 against reverse-bias spikes generated by the relay coil.

The circuit has two separate grounds: a speaker ground and a power-supply ground. Under no circumstances should these two grounds be connected together. If two circuits are used together, then three entirely separate grounds will exist: a power-supply ground and a speaker ground for each circuit (see Fig. 3-a).

Some stereo amplifiers, especially those used in car-radio amplifiers, have differential or floating-ground outputs for each channel and cannot be connected together. Figures 3-a, -b, and -c are AC model diagrams showing the equivalent connection paths between two circuits

TABLE 1

| POWER OUTPUT OF AMP (W) | 4-OHM LEAD | | | | 8-OHM LEAD | | | |
|-------------------------|-------------|--------------|------------------|--------------------|-------------|--------------|------------------|--------------------|
| | RMS VOLTAGE | PEAK VOLTAGE | R1 VALUE IN OHMS | FUSE VALUE IN AMPS | RMS VOLTAGE | PEAK VOLTAGE | R1 VALUE IN OHMS | FUSE VALUE IN AMPS |
| 10W | 6.3V | 8.9V | 5.2K | 2.2A | 8.9V | 12.7V | 9.2K | 1.6A |
| 20W | 8.9V | 12.7V | 9.2K | 3.2A | 12.7V | 17.9V | 15.2K | 2.2A |
| 30W | 11.0V | 15.5V | 12.5K | 3.9A | 15.5V | 21.9V | 19.6K | 2.7A |
| 35W | 11.8V | 16.7V | 13.8K | 4.2A | 16.7V | 23.7V | 21.5K | 3.0A |
| 40W | 12.7V | 17.9V | 15.2K | 4.5A | 17.9V | 25.3V | 23.3K | 3.2A |
| 50W | 14.1V | 20.0V | 17.4K | 5.0A | 20.0V | 28.3V | 26.6K | 3.5A |
| 60W | 15.5V | 21.9V | 19.6K | 5.5A | 21.9V | 31.0V | 29.6K | 3.9A |
| 75W | 17.3V | 24.5V | 22.4K | 6.1A | 24.5V | 34.7V | 33.7K | 4.3A |
| 85W | 18.4V | 26.0V | 24.1K | 6.5A | 26.0V | 36.9V | 36.0K | 4.6A |
| 100W | 20.0V | 28.3V | 26.6K | 7.0A | 28.3V | 40.0V | 39.6K | 5.0A |
| 120W | 21.9V | 31.0V | 29.6K | 7.8A | 31.0V | 43.8V | 43.9K | 5.5A |
| 140W | 23.7V | 33.5V | 32.4K | 8.4A | 33.5V | 47.3V | 47.8K | 5.9A |
| 150W | 24.5V | 34.7V | 33.7K | 8.7A | 34.7V | 49.0V | 49.7K | 6.1A |
| 175W | 26.5V | 37.4V | 36.8K | 9.4A | 37.4V | 52.9V | 53.9K | 6.6A |
| 200W | 28.3V | 40.0V | 39.6K | 10.0A | 40.0V | 56.6V | 58.0K | 7.0A |
| 250W | 31.6V | 44.7V | 44.8K | 11.2A | 44.7V | 63.3V | 65.3K | 7.9A |
| 300W | 34.7V | 49.0V | 49.7K | 12.3A | 49.0V | 69.3V | 72.0K | 8.7A |

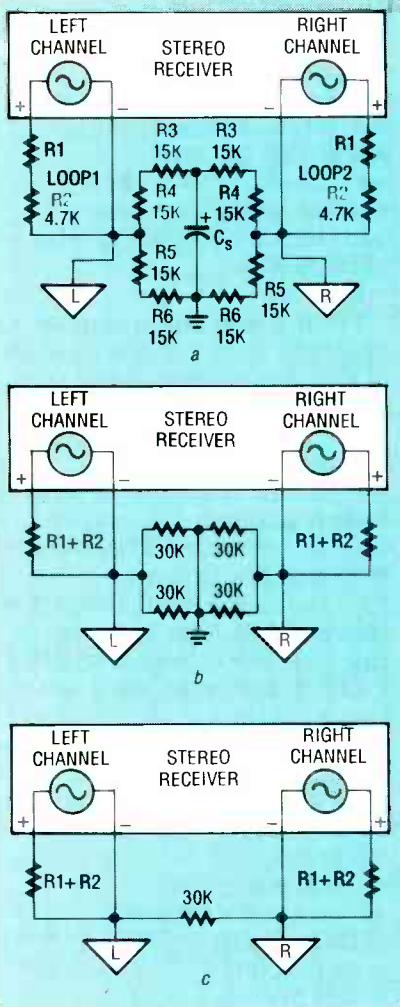

FIG. 3—THE CIRCUIT HAS A SPEAKER GROUND and a power-supply ground that should never be connected together; a shows that the current flowing in either loop is not a function of the other; b shows the power-supply capacitor from a (C_s) replaced by a wire; and, in c, the equivalent resistance between the two speaker grounds is shown as 30K.

operating from a single power supply. Figure 3-a clearly shows that the current flowing in either Loop 1 or Loop 2 is not a function of the other. The speaker grounds return to the common power supply rails through the voltage-divider resistors R3–R6. Figure 3-b shows the power-supply capacitor from 3-a, which is seen as a short to AC, replaced by a wire. Finally, in Fig. 3-c, the equivalent resistance between the two speaker grounds is shown as 30K. DO NOT short the two grounds together under any circumstance.

If the amplifier speaker grounds are connected inside the amplifier, they should NOT be connected at the speaker protec-

tion circuit's chassis. High current is assumed to be flowing in each speaker ground lead and connection of separate ground leads anywhere except inside the amplifier will degrade performance.

Calculations

To calculate the value for R1, which determines the time it takes C1 to reach nine volts, the following example analysis is presented. The first step is to calculate the RMS (average) voltage applied to the speaker terminals to obtain the rated amount of power. We'll arbitrarily use 100 watts and a speaker load of 8 ohms. From the equation:

$$P = (I^2)R$$

we can substitute values
 $100W = (I^2)8$
 divide by 8
 $12.5 = I^2$
 take the square root of both sides
 $I = 3.53$ amps
 From the equation:
 $V = IR$
 we can substitute values
 $V = 8(3.53A)$
 $= 28.28$ volts RMS
 As a final check use the formula
 $P = IV$
 we can substitute values
 $P = 3.53A(28.28V)$
 $= 99.82$ watts

To calculate the value for R1 we use the equation:
 $((V_{IN}(R2))/V_{OUT}) - R2 = R1$
 and substitute values

$$= ((28.28V(4.7K))/3V) - 4.7K$$

$$= 39.60K$$

To calculate the fuse value for amplifier short-circuit protection, use the equation:

$$V_P = V_{RMS}/0.707$$

and substitute values
 $28.28V/0.707 = 40$ volts
 From the equation:

$$I = V_P/R$$

we can substitute values
 $40V/8$ ohms
 $= 5$ amps

If you would rather avoid making all of the calculations, Table 1 shows the correct resistance values to be used for R1 for 10- to 300-watt applications. Appropriate fuse values are also provided in Table 1.

The next step is to calculate the maximum time that C1 will charge, and the voltage level it will reach before it is discharged, under normal operating conditions. This is a necessary analysis in order to prove that the circuit will not trigger falsely when peak audio power levels are reached. The lowest frequency normally associated with audio is 20 Hz. It has the longest time period (50 milliseconds) in the audio spectrum so we'll use it for analysis of the speaker protector circuit. (An actual audio signal is quite complex, but the complexity of the waveforms only decreases the time that C1 will charge, so we'll therefore use 20 Hz.)

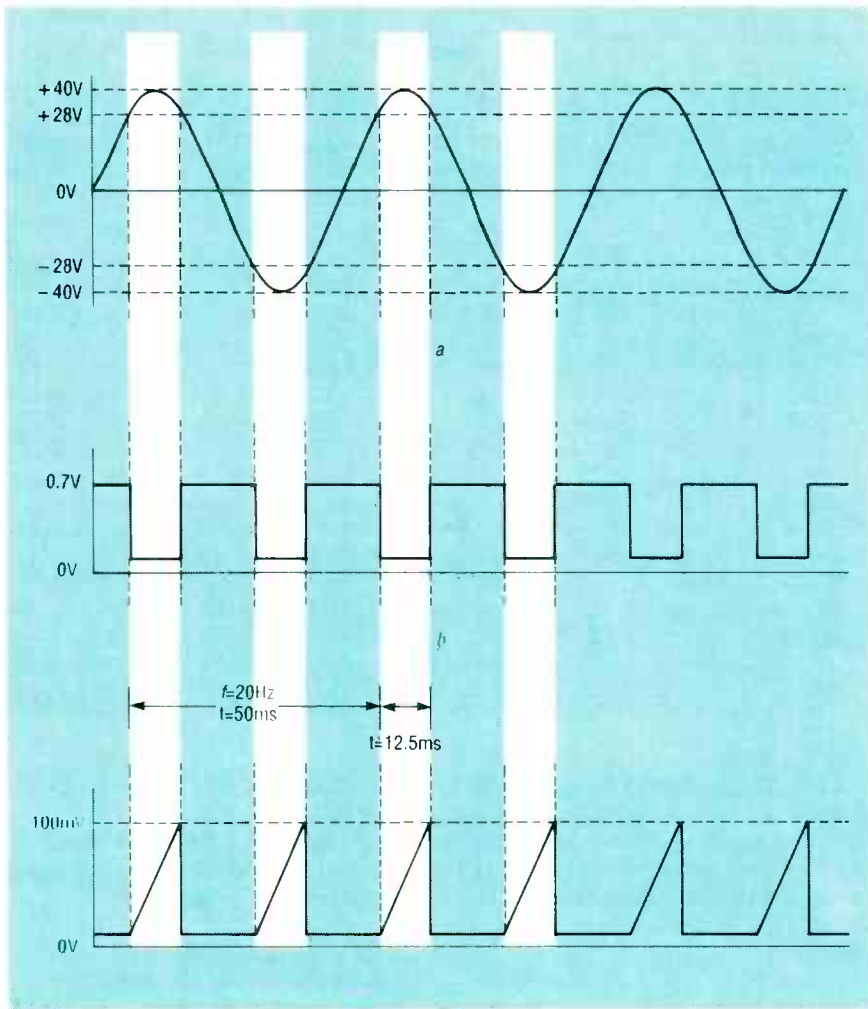

FIG. 4—SHOWN IS THE INPUT TEST SIGNAL (a), the Q1 base voltage (b), and the Q1 collector voltage (c).

$e_1 = E_M(\sin(360f))$
 we divide by E_M
 $e_1/E_M = \sin(360f)$
 we now take the inverse sign
 $\sin^{-1}(e_1/E_M) = 360f$
 and divide by 360f
 $(\sin^{-1}(e_1/E_M))/360f = t$
 now we substitute values
 $(\sin^{-1}(28.28/40))/360(20\text{Hz})$
 $= 45/7200$
 $= 6.25 \text{ ms}$

From those equations we can conclude that, for the sine wave of Fig. 4-a to travel from 0 to 28 volts ($0.707 \times$ peak value), it takes 6.25 ms, or one eighth of the total period (50 ms) of the waveform. 6.25 ms is also the time it takes the sine wave to return to zero volts. Therefore:

$6.25 \text{ ms}(2) = 12.5 \text{ ms}$
 12.5 ms is the total time C1 will charge (4-c). The last step is to calculate the voltage level of C1 at $t = 12.5 \text{ ms}$, and we'll assume that e_c is the capacitor voltage at t , E is the power-supply voltage (12V), e equals 2.718, t equals 12.5 ms, C equals $22 \mu\text{F}$, and R equals 68K. Now we take the equation:

$$e_c = E(1 - e^{-t/(CR)})$$

and substitute values

$$= 12(1 - 2.718^{-12.5\text{ms}/(22\mu\text{F})68\text{K}})$$

$$= 12(0.0084)$$

$$= 100 \text{ mV}$$

The speaker protector circuit will disconnect the amplifier from the speaker after a 2-second interval using the values shown for R8 and C1. That amount of time will protect the speaker under most circumstances. Charging time for C1 to reach 9 volts can be calculated by rearranging that equation and assuming that e equals 2.718. \ln is the natural log (the inverse of e^x). E is the power-supply voltage (12V), e_c is the capacitor voltage (9V), t is the time for C to charge to 9V, C equals $22 \mu\text{F}$, and R equals 68K. The rearranged equation is:

$$t = CR(\ln(E/E - e_c))$$

now we substitute values

$$t = (22 \mu\text{F})(68\text{K})(\ln(12/(12 - 9)))$$

$$= 1.49(1.39)$$

$$= 2.0 \text{ seconds}$$

To change the time delay for the speaker protector circuit to disconnect the speaker from a DC voltage use the equation $R8 = t/1.39C$ to recalculate the value of R8.

Construction

Construction of the protector

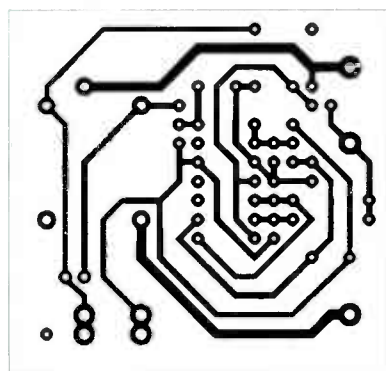

MAIN FOIL PATTERN shown actual size.

Capacitor C1 will charge whenever the input voltage exceeds the RMS voltage level necessary to produce 100 watts if R1 is equal to 39.6K. Figure 4 shows the analysis waveforms for the circuit; shown is the input test signal (a), the Q1 base voltage (b), and the Q1 collector voltage (c). Referring to Fig. 4-a, to calculate the time that the input waveform

is between 28 and 40 volts, we'll first assume that e_1 is the instantaneous voltage level (28.28 VRMS). E_M is the maximum or peak voltage level (40.00V_p), the frequency is f (20 Hz), π (π) is equal to 3.14, t is the time for sine wave to reach 28.28 V_{RMS}, and that 2π radians equals 360 degrees (and we'll stick to degrees from this point on). That out of the way, from the equation:

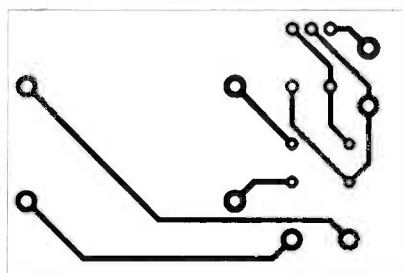

POWER SUPPLY FOIL PATTERN shown actual size.

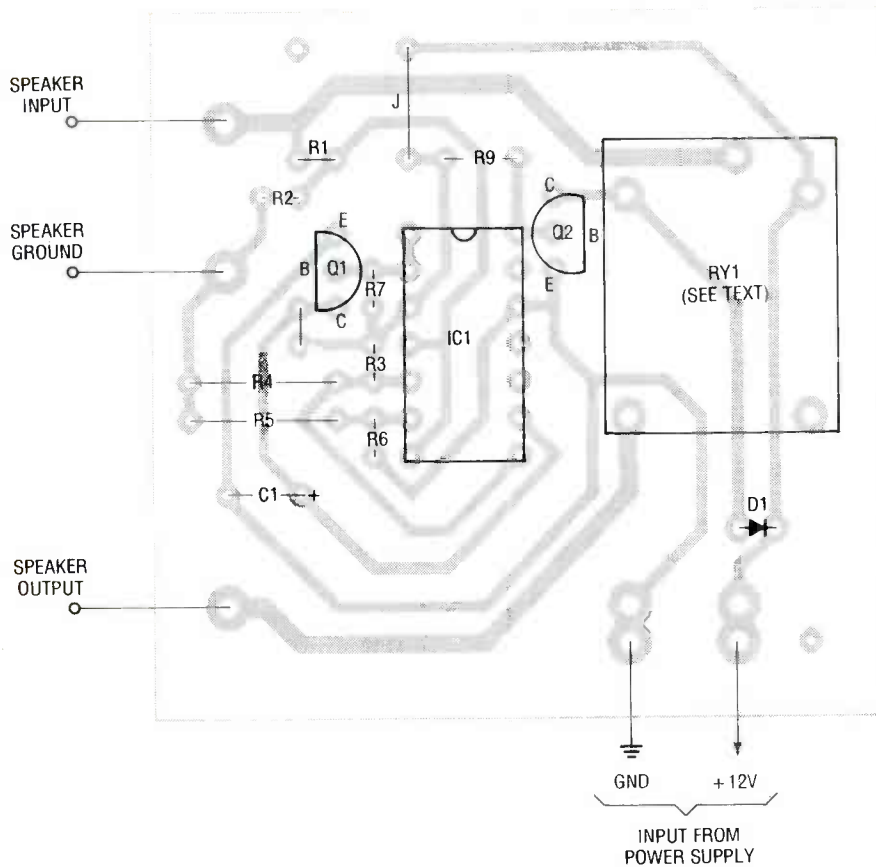

FIG. 5—PARTS-PLACEMENT DIAGRAM for the protector circuit. The 5-amp relay will mount right on the board, while the 15-amp relay must be mounted on the edge of the board using double-sided tape.

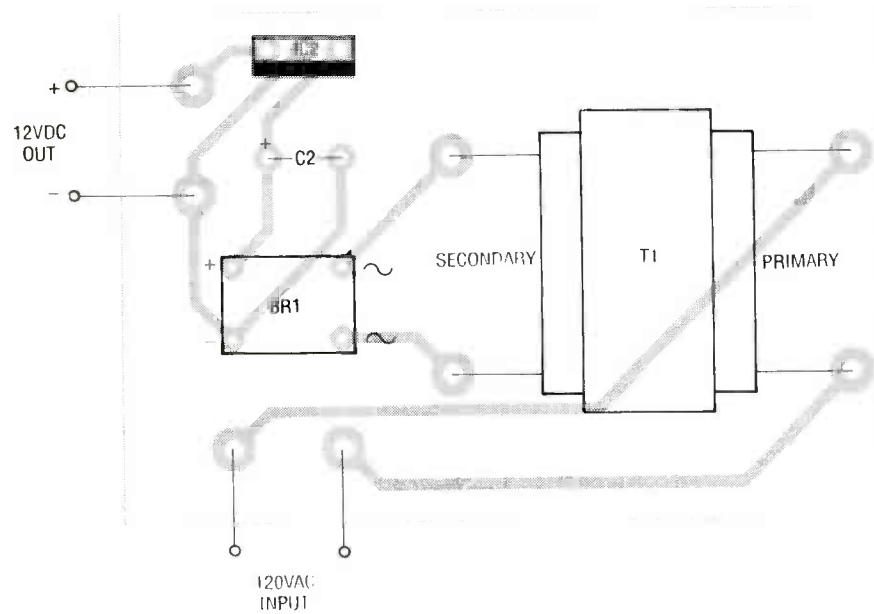

FIG. 6—PARTS-PLACEMENT DIAGRAM for the power-supply board.

circuit depends on the intended use. Once you have a clear idea of the application, then you can customize the circuit to meet your needs. To use the circuit to protect car-stereo speakers, re-

place R4 and R5 with 3-volt Zener diodes. That will ensure that the window-comparator reference voltages, with respect to analog ground, will be independent of the DC supply voltage. For power

PARTS LIST

All resistors are 1/4-watt, 10%.
R1—value depends on your setup (see text and Table 1)

R2—4700 ohms

R3—R6—15,000 ohms

R7, R8—100,000 ohms

R9—2200 ohms

Capacitors

C1—22 μ F, 35 volts, radial electrolytic

C2—470 μ F, 35 volts, radial electrolytic

Semiconductors

IC1—LM339N quad open-collector voltage comparator

IC2—7812 12-volt regulator

D1—1N4004 diode

D2—ECG 5065A 3-volt Zener diode (required for optional 9-VDC output, see text)

Q1, Q2—2N2222 NPN transistor

BR1—ECG 5882 1-amp bridge rectifier

Other components

T1—120/12-VAC 300-mA transformer

RY1—5- or 15-amp relay (see text)

J1—optional 9-VDC jack (whatever type best suits your needs)

Miscellaneous: PC boards, AC plug and line cord, 18-gauge stranded hookup wire, cabinet(s), speaker-input and -output jacks (RCA jacks, spring-terminal board, etc.), solder, etc.

Note: The following items are available from Applitron Electronics, 2721 Creswell Road, Bel-Air, MD 21014: Kit of parts for the speaker protector circuit including an etched and drilled PC board and all parts that mount on it for \$14.95. Please specify the value of R1 you desire (standard 10% values only) and P.A./guitar, home stereo, or automotive version. Add an additional \$3.50 for the optional high-current (15 amp) relay. A kit of parts for the 12-volt supply is also available that includes an etched and drilled PC board and all parts that mount on it for \$14.95. Include \$1.95 postage and handling for each kit ordered and allow 3–4 weeks for delivery. Maryland State residents must add 5% sales tax.

levels below 100 watts, you can use the 5-amp relay shown in the parts list; above 100 watts, you must use a 15-amp relay.

The parts-placement diagram for the protector circuit is shown

in Fig. 5. The PC board is configured for on-board mounting of the 5-amp relay that the author used.

A compatible relay with a different pinout can be used. However, it may have to be mounted on the edge of the board using double-sided tape; it will then have to be hardwired to the board. The parts-placement diagram for the power-supply board is shown in Fig. 6.

After mounting all compo-

nents, solder leads of adequate length to the boards, and use different colors for the speaker and power ground leads to avoid connecting them together. Next, connect the power leads between boards, and connect an AC line cord to the power supply. The author's completed unit, containing a protector circuit for both the left and right channels and one power supply, is shown in Fig. 7.

The completed boards can be



FIG. 7—HERE'S THE AUTHOR'S PROTOTYPE. It contains a protector circuit for both the left and right channels and one power supply. The entire unit is only about 4 inches wide by 6 inches long.

mounted in a case like the one pictured in Fig. 7. Otherwise you can use whatever case you like. When drilling holes in plastic cases, start with a small drill bit and work your way up to the final size. Otherwise you may find yourself with a handful of plastic fragments.

As a final word, the circuit is designed to protect speakers from excessive DC levels caused by amplifier failure. However, it will not protect a speaker that's rated at power levels much less than the driving amplifier can supply—only your own common sense in keeping the volume down will protect your speakers in a situation like that.

R-E

Special LEADER Special
DSOs
Limited Quantity

Model 3060D
\$4485 \$2999

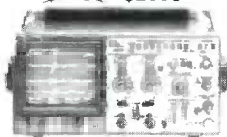

40-MS/s DSO/60-MHz Analog

The 3060D is a CRT readout, 40-MS/s Digital Storage and 60-MHz Real Time Oscilloscope featuring 4k memory, sine and pulse interpolation, X100 expansion and video line select of field 1 and 2.

LBO-5825
\$2950 \$1999

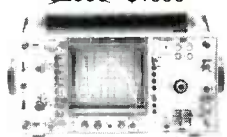

5-MS/s DSO/35-MHz Analog

A versatile DSO and 35-MHz real time oscilloscope packed with features that are not normally found on DSOs of its class, it uses a separate A/D converter for each channel.

RF CONNECTORS

BNC Self-Terminating Receptacles
(Built-in Resistance)

When the plug is removed, the receptacle termination closes to maintain the internal circuit electrical current automatically.



Also available are reliable high quality circular connectors for sophisticated industrial applications.

Call for a free catalog.

1 800-372-1616
212-691-9050 in NY

direct sound

DIRECT SOUND CORPORATION
150 FIFTH AVE., SUITE 842 • NEW YORK, NY 10011

CIRCLE 193 ON FREE INFORMATION CARD

Save on cable rental fees!

**CABLE TV
DESCRAMBLERS
WE'LL BEAT
ANY PRICE!**

CALL TOLL-FREE 1-800

284-8432

JERROLD-TOCOM-ZENITH
HAMLIN-OAK-PIONEER
SCIENTIFIC ATLANTIC

- 24 HOUR SHIPMENTS!
- MONEY BACK GUARANTEE!
- FREE CATALOG & INFO!
- QUANTITY DISCOUNTS!

MASTER CARD / AMEX / VISA / C.O.D.



Have make and model number of equipment used in your area ready

**1-800-284-8432
CABLE WAREHOUSE**

4700 N. HIATUS ROAD, SUNRISE, FLA. 33351
NO FLORIDA SALES

CIRCLE 189 ON FREE INFORMATION CARD

**LEARN
Advanced
VCR
REPAIR TECHNIQUES**



Now, in a **complete** multimedia package consisting of a 200-page training manual and a 1-hour 22-minute video training tape, you can learn **secrets** of Advanced VCR Repair. (Also includes Color Bar Test Tape.)

Includes many examples of VCR make/model specific troubleshooting tips... Learn how to quickly isolate most "tough" VCR malfunctions, whether electrical or mechanical.

Complete coverage of Theory of Operation — Read manual, view 1-hour 22-minute video!

FREE INFORMATION PACKAGE!

Call 1/800-537-0589

Viejo Publications, Inc.
5329 Fountain Ave., Dept. REA
Los Angeles, CA 90029

CIRCLE 192 ON FREE INFORMATION CARD

Try the

**Radio
Electronics®**

bulletin board
system

(RE-BBS)

516-293-2283

The more you use it the more useful it becomes.

We support 1200 and 2400 baud operation.

Parameters: 8N1 (8 data bits, no parity, 1 stop bit) or 7E1 (7 data bits, even parity, 1 stop bit).

Add yourself to our user files to increase your access.

Communicate with other R-E readers.

Leave your comments on R-E with the SYSOP.

**RE-BBS
516-293-2283**

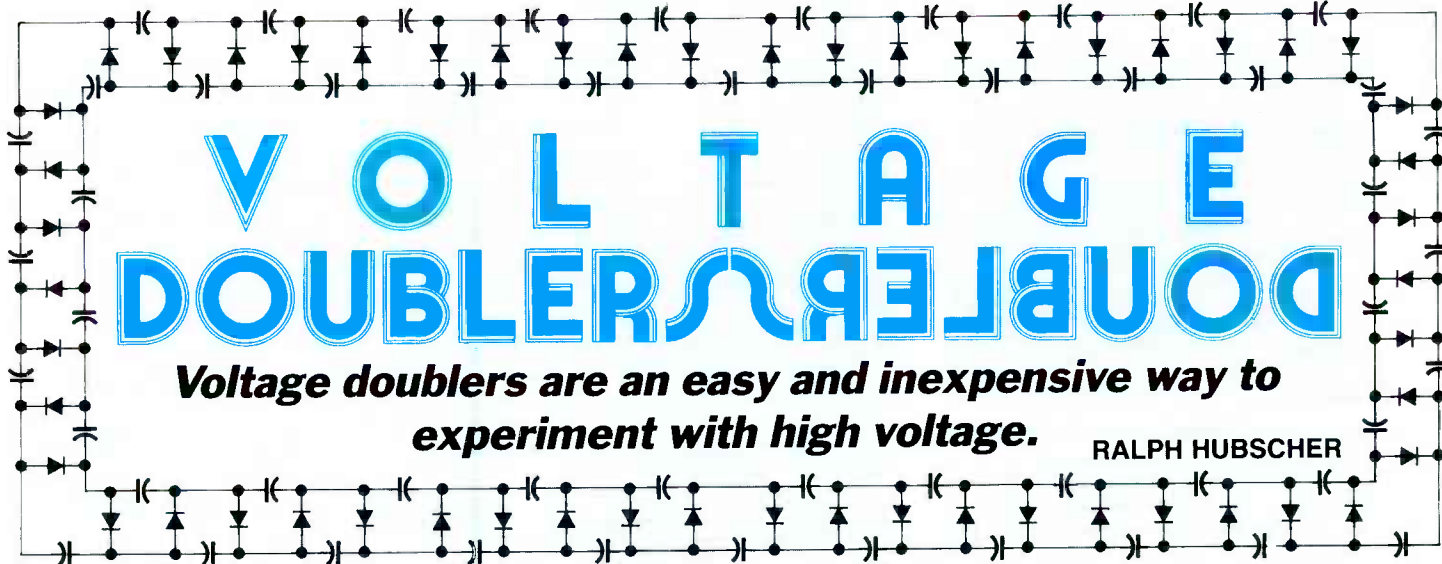

VOLTAGE DOUBLERS ARE
Voltage doublers are an easy and inexpensive way to experiment with high voltage.

RALPH HUBSCHER

IF YOU'VE BEEN LOOKING FOR A WAY to generate high voltage, you've undoubtedly run across the voltage doubler. Voltage doubling using diode-capacitor combinations is a common practice. However, whole banks of doublers, called cascades, can also be used for producing extremely high DC voltages from moderate to high AC voltages. Such high DC voltages may be needed for TV sets, lasers, air purifiers, industrial smoke-stack dust removers, negative-ion generators, and, of course, for experimenting, on which we'll concentrate here.

Half-wave doubler

Figure 1 shows a half-wave voltage doubler; we'll assume that C1 and C2 are initially discharged. During the first half-cycle shown in a, the upper input terminal is positive and the bottom negative, so D1 conducts and C1 charges to about 170 volts peak. Diode D2 can't conduct, since it's back-biased, so C2 discharges through R_L . In the second half-cycle (b), the analysis is similar, except that D2 conducts and C2 charges.

The circuit is really a transformerless voltage amplifier. While T1 can provide isolation, as well as increase the AC voltage initially going into the doubler, the amplification due to the doubling action would occur without it. When the polarity reverses, both the input voltage and the charge across C1 are in series like two batteries, producing about 340 volts peak. One problem, though, is that a half-wave doubler can't be used with a load that draws much current.

Full-wave doubler

Let's see how a full-wave voltage doubler is related to and built from both positive and negative half-wave rectifiers. Figure 2-a shows a half-wave rectifier with a positive output, Fig. 2-b shows the same version with a negative output, and Fig. 2-c shows the two combined into a full-wave voltage rectifier.

The full-wave voltage doubler shown in Fig. 3 has been redrawn for greater clarity; it has better regulation than a half-wave version, and is easier to filter. The circuit produces nearly double the peak AC voltage of 170 volts, or about 340 volts peak across R_L . For the first half-cycle (a), D2 is cut off and D1 conducts, so that V_{C1} equals approximately 170 volts DC. On the next half-cycle (b), the positive voltage is replaced by a negative voltage, so D2 conducts and D1 is cut off. R_L goes across C1 and C2 in series, effectively creating a doubled level of about 340 volts DC.

Warning!! This article deals with and involves subject matter and the use of materials and substances that may be hazardous to health and life. Do not attempt to implement or use the information contained herein, unless you are experienced and skilled with respect to such subject matter, materials, and substances. Neither the publisher nor the author make any representation as for the completeness or accuracy of the information contained herein, and disclaim any liability for damages or injuries, whether caused by or arising from the lack of completeness, inaccuracies of the information, misrepresentations of the directions, misapplication of the information, or otherwise.

Unlike the half-wave voltage doubler, the full-wave version has two capacitors across R_L rather than one. Whereas C1 shown in Fig. 1 is cut off and uncharged for half of every cycle, C1 and C2 in Fig. 3 are supplied on alternate half cycles. When the capacitor corresponding to the diode that's cut off discharges, it can only do so through the capacitor being supplied, slightly decreasing both its current and the maximum voltage it reaches.

Measuring high-voltage DC

Voltage measurements will be possible only to about the second or third stage of a cascaded voltage doubler with most voltmeters. Beyond that, you'll need to use either a high-voltage DC meter or an external voltage divider for use with a standard high-impedance voltmeter (10 megohms or more).

A good voltage divider that can be used for the purpose of high-voltage measurements is the RCA SK3868/DIV-1, a high-voltage DC divider; it's used in TV's to reduce the final anode voltage going to the CRT to the level required for the focus voltage. It consists of resistors R1 (200 megohms) and R2 (40 megohms) in series, as shown in Fig. 4. There are three leads, one for the free ends of each resistor, and the other at their juncture. If you put both a 10-megohm meter (shown as Z_M in Fig. 4) and a 2.7-megohm resistor (R3) in parallel with the 40-megohm resistor (R2), you can achieve almost exactly 100:1 range multiplication, for a full-scale deflection of 20 kilovolts DC.

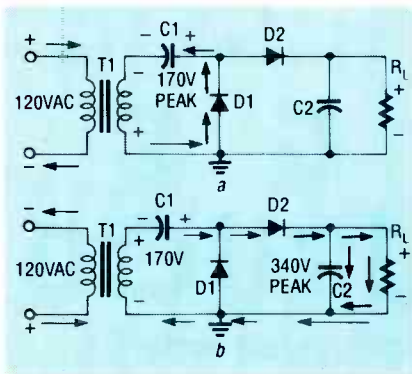

FIG. 1—HALF-WAVE VOLTAGE DOUBLER. During the first half-cycle (a), D1 conducts, D2 cuts off, C1 charges to 170 volts peak, and C2 discharges through R_L . For the second half-cycle (b), the input polarity is reversed, and both the input and C1 are in series, producing 340 volts peak. Now D1 cuts off while D2 conducts, and the current divides between C2 and R_L ; the cycle then repeats.

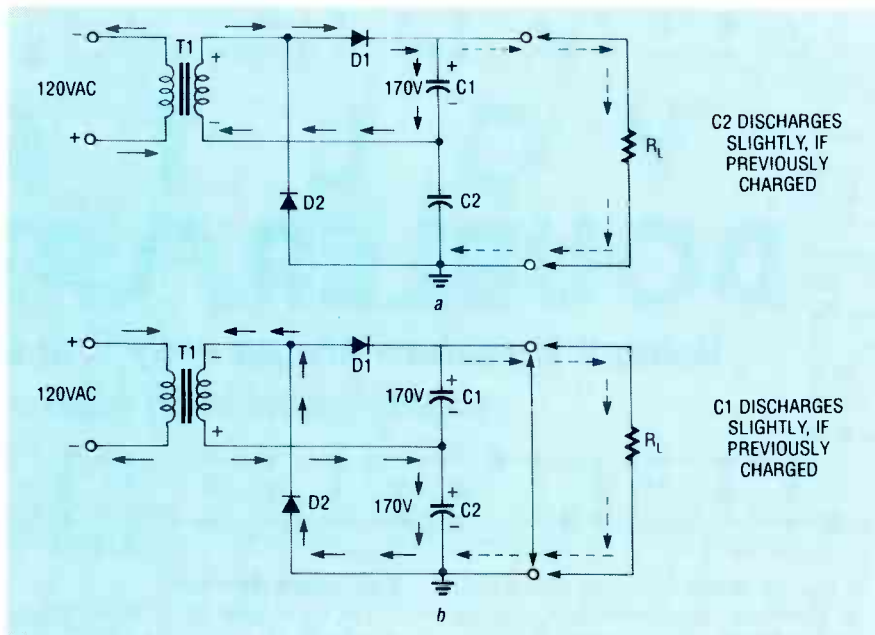

FIG. 3—FULL-WAVE VOLTAGE DOUBLER, redrawn for greater clarity. For the first half-cycle (a), D2 is cut off and D1 conducts, producing about 170 volts DC across C1. On the next half-cycle (b), D2 conducts and D1 is cut off. The output voltage is now across C1 and C2 in series, doubling the level to about 340 volts DC.

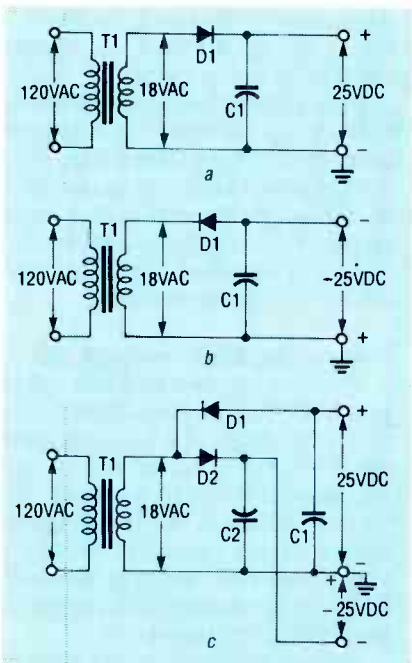

FIG. 2—TWO HALF-WAVE RECTIFIERS, one with a positive output (a) and one negative (b), combine to make a full-wave voltage doubler (c).

Cascaded voltage doublers

Figures 5–8 show four additional voltage doublers. The one shown in Fig. 5 is the most straightforward. If you build it, use 1N4007 diodes with peak inverse voltage (PIV) ratings of 1 kilovolt for D1–D6, and 0.068–0.1 μF capacitors with working voltages of 400 volts DC. Figure 5 is electrically identical to the one in Fig. 6, so keep that in mind if you should come across either format. Figure 7 shows an extended version that's better

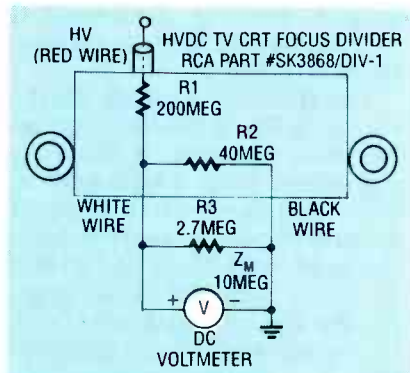

FIG. 4—TO MEASURE HIGH VOLTAGES with an ordinary 10-megohm meter, you can use the RCA SK3868/DIV-1 high-voltage divider. The circuit provides a 1:100 voltage division, allowing 20 kilovolts to be measured on a 200-volt scale.

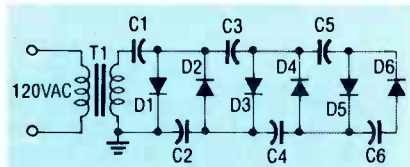

FIG. 5—THIS CASCADED DOUBLER uses 1N4007 diodes rated at 1 kilovolt PIV, and capacitors from 0.068–0.1 μF with a 400-volt DC working voltage.

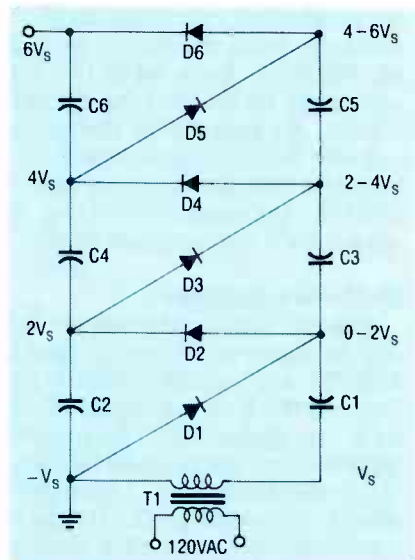

FIG. 6—THIS VOLTAGE DOUBLER is the same as the one shown in Fig. 5, although it's drawn differently. You should be able to recognize both versions.

stabilized for moderate-current applications; it's called either a Cockcroft-Walton or Greinacher cascaded voltage doubler.

You can use a sewing needle as an emitter for the doubler shown in Fig. 8 to generate "corona wind." That will sound like a his-

sing noise. (We'll show you how to demonstrate the "wind" later on.) The circuit delivers 3.75 kilovolts DC when powered from 120 volts AC, or 7.5 kilovolts DC when powered from 240 volts AC.

The output of a cascaded voltage doubler should be terminated with at least 200 megohms, and only then be allowed to extend beyond a protective plastic case, for safety. Voltages as high as 5 megavolts DC have been generated using

cascaded voltage doublers, especially when operating in a pressurized atmosphere. The biggest advantage to using voltage doublers is that they use inexpensive low-voltage parts. Otherwise, if all the parts had to be of the high-voltage variety, you would have to use expensive and rather large capacitors like the one shown in Fig. 9.

If you have problems with the circuit in Fig. 8 (or any other high-voltage circuit), you must discharge every capacitor (we'll tell you how in a minute) before you check for malfunctions. When examining the circuit for problems, closely check the solder connections, and then the diode directions and continuity. The 1N4007's should have a resistance of 1.1K when forward-biased and be open when reverse-biased, while the capacitors

should all have infinite resistance.

To properly discharge capacitors, build a discharging wand like the one shown in Fig. 10. Use a 2-foot wooden (or plastic) dowel, and connect a stiff wire tip



FIG. 9—HIGH-VOLTAGE CAPACITORS. A 0.25 μ F, 7.5-kilovolt capacitor is on the left; a 100 pF, 15-kilovolt capacitor is in the middle; and 0.0005 μ F, 5-kilovolt capacitor is on the right.

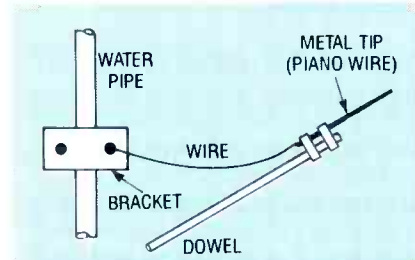

FIG. 10—A HIGH-VOLTAGE GROUNDING wand is used to discharge capacitors. A 2-foot wooden dowel is attached to a stiff wire tip. The metal tip must be connected to an earth ground, such as a cold-water pipe.

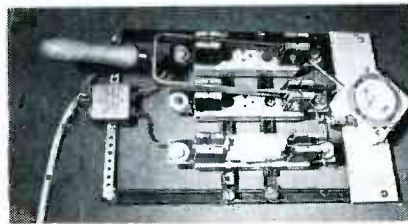

FIG. 11—HOMEMADE SWITCH for high-voltage DC. The line filter at left is a safety measure to keep high-voltage DC out of the house wiring.

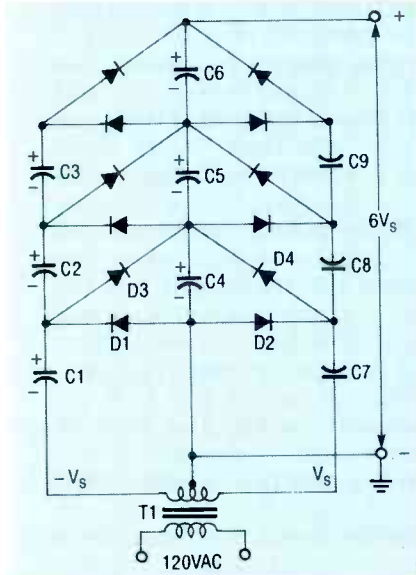

FIG. 7—THE COCKCROFT-WALTON, or Greinacher cascaded voltage doubler, has improved performance for moderate-current applications.

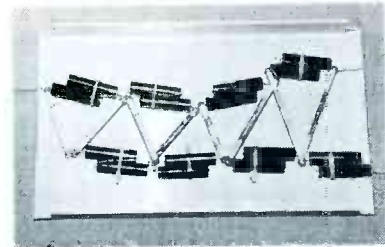

FIG. 12—A TYPICAL CASCADED voltage doubler. Note the wide spacings between the diodes, the long connecting wires, and the smooth solder joints.

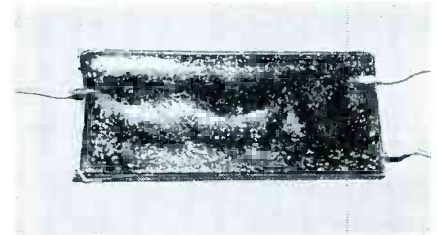

FIG. 13—THIS IS THE DOUBLER from Figure 12, after being sealed in candle wax. For better protection, you can immerse it in pure paraffin oil.

(piano wire works well) to a cold water pipe as earth ground with a good electrical connection. Discharge all capacitors twice, since they generally either hold charge, or tend to recharge from other capacitors. Don't use an AC line ground or chassis ground instead of an earth grounded water pipe, or you may blow a fuse or damage parts.

Figure 11 shows a switch for high-voltage DC that you can use with any of the cascaded voltage-doublers shown here; standard switches may present a shock hazard. Also, use an electromagnetic interference (EMI) line filter like the one seen at left in the photo to keep high-voltage DC out of house wiring, and to prevent shock from static charge. The EMI filter is from Corcom Corp. (1600 Winchester Road,

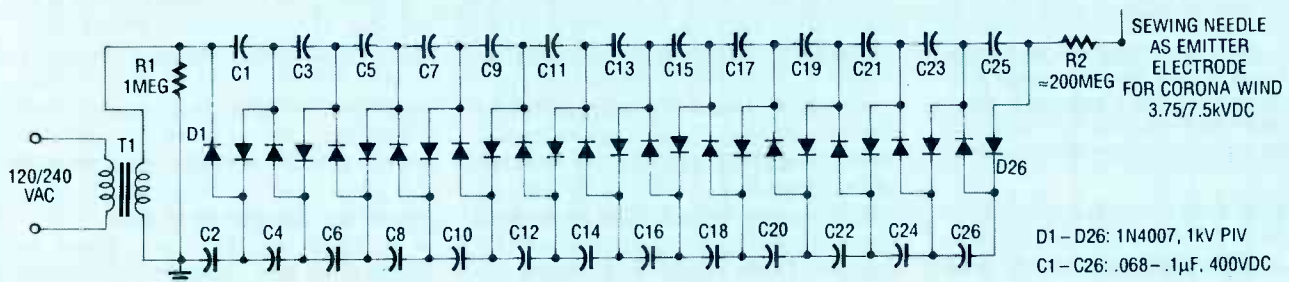

FIG. 8—THIS 25-STAGE VOLTAGE DOUBLER will generate "corona wind." It delivers 3.75 kilovolts DC when powered from 120 volts AC, or 7.5 kilovolts DC when powered from 240 volts AC.

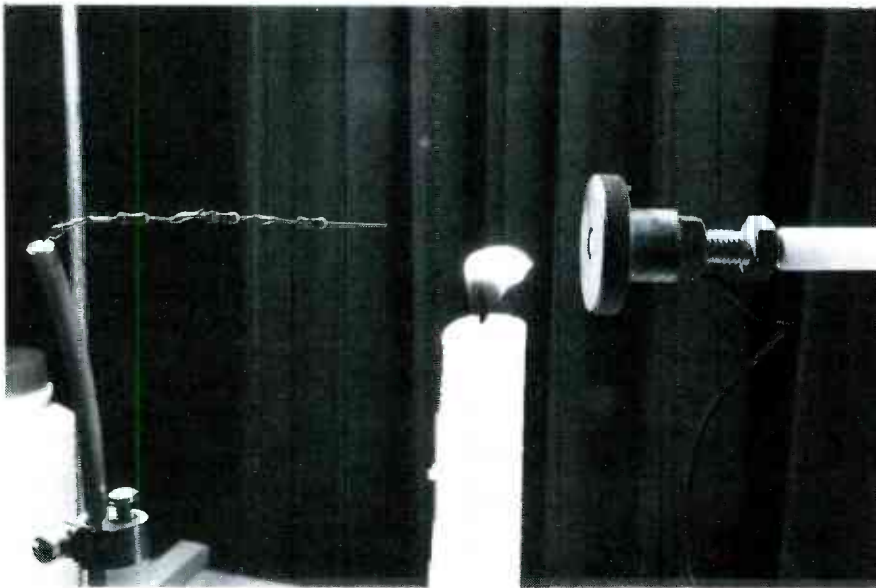

FIG. 14—CORONA WIND DEMONSTRATION. The flame will deflect toward the ground plate. Note the black ground wire attached near the screw threads.

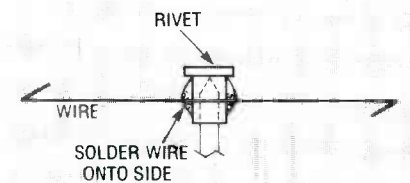

FIG. 15—THIS ION-MOTOR ROTOR, when placed on top of the sewing-needle emitter, will spin in a circle.

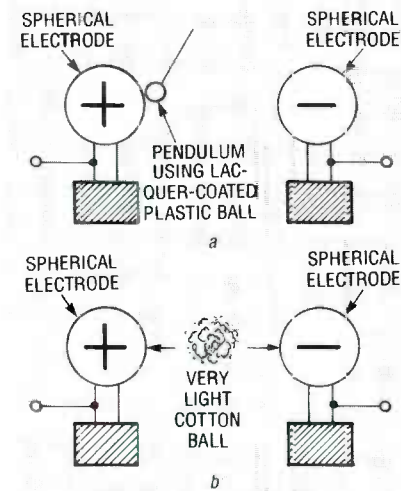

FIG. 16—TWO CHARGED DOOR KNOBS cause a suspended, lacquer-coated plastic ball to behave like a pendulum (a). A light cotton ball will bounce back and forth without being suspended on a string (b).

When you build a cascaded voltage doubler, you can encase the circuit in pure paraffin oil or candle wax to reduce the chances of getting shocked. It will also minimize corona loss, so the high-voltage DC arrives where it's needed. Figures 12 and 13 show a typical ladder-type voltage doubler before and after being sealed in wax.

Experiments

There are many experiments that can produce observable effects due to the high-voltage DC produced by voltage doublers.

- With a high-voltage emitter pointed at a ground plate (used to attract ions), with a burning candle placed in between them (see Fig. 14), you'll see the candle flame deflect toward the metal plate.

- You can make a rotor for an ion motor, using a light pivot made from a rivet with thin, stiff wire (like piano wire) attached, as shown in Fig. 15. The rotor must be balanced on top of the sewing-needle emitter (much as in a compass) used for the doubler shown in Fig. 8. (We ran a similar construction project in **Radio-Electronics**, February, 1991.) When powered up, the rotor will spin and a hissing sound will be heard. Both ends of the wire are bent at opposite right angles, so the emitted electrons propel the wire in a circle. You should sharpen both ends of the rotor wire to provide a sharp surface

good for corona generation and electron emission. The sharpened ends will have a small radius of curvature (a tight curve or bend), giving rise to a highly distorted electric field at its surface. The high electric field is what tends to ionize air molecules in the vicinity.

- Another experiment you could try involves holding a fluorescent tube near the emitter. The tube will glow, but be careful not to touch the terminals on the ends, or you'll get a shock.

- Lines of force of an electrostatic field can be demonstrated by placing the electrodes (the high-voltage DC output and ground) in a tray covered with castor oil containing some farina. The farina will produce the pattern of the electric field lines; similar to iron filings shaken lightly on a piece of paper in the presence of a bar magnet.

- If you place two round door knobs on insulated stands made from plastic cups filled with candle wax, and then charge them, then a plastic ball suspended from a string will be drawn to and touch the positive electrode, and fall back to center when the spheres are discharged (see Fig. 16-a). A plastic ball coated with conductive lacquer swings toward the positive electrode like a pendulum; when the ball and doorknob touch, the ball becomes positively charged, so they repel one another. It then swings toward the negative side, absorbs electrons, becomes negatively charged, and is repelled back to the positive. The process repeats indefinitely as long as the high-voltage DC is present, and it will continue to operate for some time after it's shut off. The charge exchange is slow, and there'll be arcing at the positive electrode.

- A grounded metal ball alternates between both electrodes, like the conducting plastic ball. However, the arcs are smaller due to its greater weight, and should be observed at both ends, but more on the positive side.

- A light cotton ball should be drawn to the positive electrode and hang there by itself, as shown in Fig. 16-b. It's then repelled 0.5-inch toward the negative electrode, and the process should repeat indefinitely. **R-E**

An Intuitive Look At Electromagnetic Theory

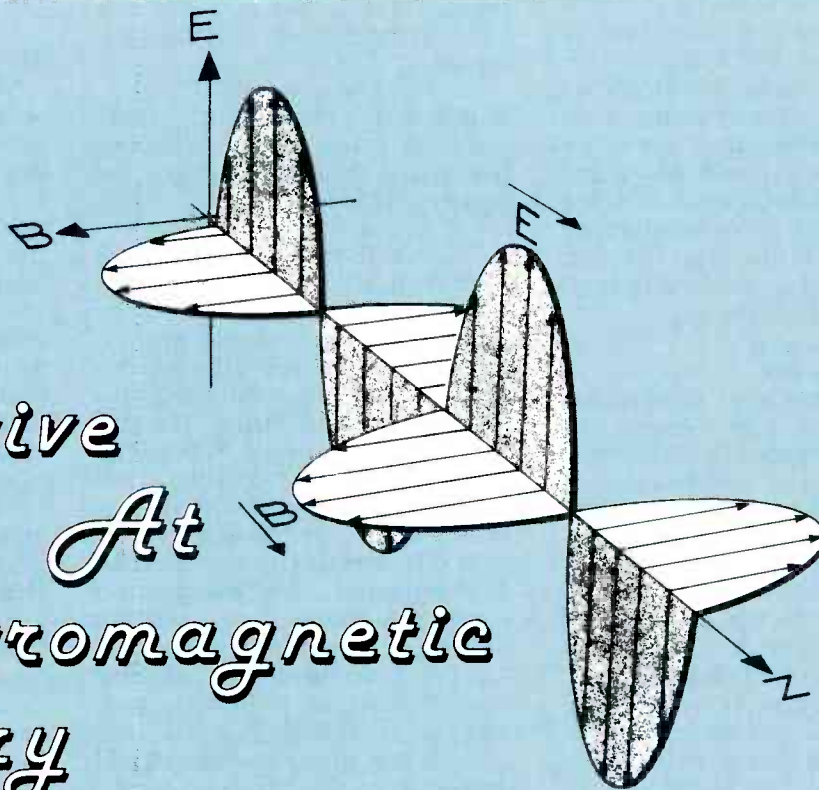

WILLIAM P. RICE

SOME OF OUR READERS MAY NOT BE aware that 1991 marks the 100th anniversary of the third edition of James Clerk Maxwell's *A Treatise on Electricity and Magnetism*, the ultimate reference on electromagnetic theory. What better way to recognize the impact that Maxwell had on the study of electromagnetics than to present the first of a series of articles in **Radio-Electronics** on the subject? In this edition, we will take a physical, intuitive look at the basics of electromagnetism, how they relate to some common electronic components, and how to interpret some of the complex mathematical symbolism. Only a familiarity with vector algebra is needed.

Maxwell's equations were first formulated in 1873. In his first publication, a mathematical foundation for relating electric and magnetic effects were given. In the Preface to the 1891 edition, J.J. Thomson noted that most of his students had difficulty with some aspects of electromagnetic theory. One hundred years later, not much has changed in that regard. One reason is that electromagnetic theory requires

knowledge of some involved mathematics such as vector and tensor calculus and integral-differential equations.

Maxwell's idea that a changing electric field gives rise to an associated magnetic field developed from an intuitive sense for the natural order in the world. By presenting physical concepts in such an "intuitive" way, the reader will find it easier to understand Maxwell's equations, and his mathematical approach. Let's begin by examining the concept of an electric field.

The electric field

A scalar can be thought of as a quantity that can be completely characterized by its magnitude. Some examples of scalar quantities are mass, time, and volume. A scalar field is simply an extension of the scalar concept. It is a function of position that is specified by its magnitude at all points in a region of space. Land elevation is a two-dimensional scalar field because at each point of latitude and longitude there is an associated height above sea level. Air temperature is an example of a three-dimensional scalar field. With the appropriate in-

strument one could measure the height, or temperature, at each point. A scalar quantity is symbolized by a letter, such as h , for height.

A vector is a quantity that is characterized by its magnitude and direction. Some examples of vectors are velocity, acceleration, and force. A vector field is a function of position that is specified by its magnitude and direction at all points in a region of space. An example of a vector field is air velocity, where at each point in space, the magnitude and direction of air flow can be measured with the proper instrument. Vectors are often symbolized by letters with arrows above them, however, we will use boldface letters to indicate vectors.

When using vector notation, \mathbf{A} is a vector with a specific magnitude and direction, and $-\mathbf{A}$ is a vector of the same magnitude but pointing in the opposite direction. Vectors are illustrated graphically by arrows, which have a direction and a corresponding length, which is proportional to the magnitude.

The field concept allows us to associate something that happens at one point with what hap-

pens at another point even though there may be no material objects connecting those points; examples are air temperature and velocity fields. Although we will not be directly concerned with them here, there are other types of fields, such as tensor fields, that assign a set of three vectors to each point in space, or quantum fields that assign mathematical operations to each point in space-time.

Electric charges

Experiments have shown that electric charges are either positive or negative. Like charges repel each other, unlike charges attract. The unit of charge is the Coulomb, C. The smallest magnitude of charge, e , is equal to $e = 1.60 \times 10^{-19} \text{C}$.

Charge follows the principle of conservation, which states that the net sum of all charges in an isolated system remains constant. A charge can be moved, but it cannot be created without the creation of an equal and opposite charge.

Experiments by Coulomb showed that if a charge, q_1 , was placed at a point in empty space, nothing appears to happen. But if another charge, q , is placed at some other point, as shown in Fig. 1-a, it will experience a force in newtons

$$F_c = \left[k \frac{qq_1}{r_1^2} \right] \mathbf{r}_1$$

where \mathbf{r}_1 represents a vector of magnitude 1 (a unit vector which defines the direction) directed from q_1 to q . \mathbf{r}_1 is the separation distance in meters. The constant of proportionality, k , is a number that is chosen to make the units work out. Coulomb's constant, k , has the value in a vacuum of $k = 9.0 \times 10^9 \text{ N}\cdot\text{m}^2/\text{C}^2$

The value of k in air is slightly greater. Using the mks system, the constant k can also be written as

$$k = 1/(4\pi\epsilon_0) \text{ N}\cdot\text{m}^2/\text{C}^2$$

which will give familiar units such as volts, ohms, and amperes. ϵ_0 is the permittivity of free space, and is equal to

$$\epsilon_0 = 8.85 \times 10^{-12}$$

The Coulomb force, \mathbf{F}_c , on a charge, q , will have a magnitude proportional to the product of the charges, and inversely proportional to the square of the separation distance. That force will also be directed away from q_1 . If one of the charges is negative, then the direction will be opposite. That force tends to provide an acceleration, \mathbf{a} , to q in the same direction. There is, of course, an equal and opposite force on q_1 , and Coulomb's law for that is written by simply redefining \mathbf{r} .

If there is a number, n , of point charges instead of just q_1 present, as shown in Fig. 1-b, the force vector of each would all add vectorially to give the total force

$$F_c = \left[k \frac{qq_1}{r_1^2} \right] \mathbf{r}_1 + \dots + \left[k \frac{qq_n}{r_n^2} \right] \mathbf{r}_n = kq \sum_{k=1}^n \left[\frac{1}{r_k^2} \right] \mathbf{r}_k q_k$$

The fact that the vector forces add in this manner is called linear superposition.

If a charge q is spread out over a region of space instead of being located at one point, we consider the charge by dividing it up into an infinite number of infinitesimal charges, dq , and sum the contributions from each. The force that is exerted on a charge q_0 at another point is given by the calculus notation

$$\mathbf{F}_c = kq_0 \int \left(\frac{1}{r^2} \right) \mathbf{r} dq$$

where the integration symbol \int can be "read" as the sum of an

infinite number of infinitesimal contributions.

The electric field \mathbf{E}

Coulomb's law defines the force only at one point where q is located. It does not define a field in the sense used here, but it provides a starting point to develop the idea of an electric field. Suppose we make q a very small positive charge and use it as an instrument to explore all points other than where q_1 is located. Since q experiences a force \mathbf{F}_c at every point it is placed, we get the impression that the condition of space is affected by the presence of q_1 . We can amend the statement that "if q_1 were alone in space, nothing appears to happen" to "if q_1 were alone in space, then space has the propensity to exert a force on another charge, if it is present, according to Coulomb's law." Since that inclination appears to apply to space, independent of any q , we divide q out of Coulomb's law to obtain a definition of the electric field (also called electric field intensity)

$$\mathbf{E} = \frac{F_c}{q} = \left[k \frac{q_1}{r_1^2} \right] \mathbf{r}_1$$

which can be thought of as a measure of the propensity. \mathbf{r}_1 is a unit vector pointing from q_1 to whatever point in space is being considered and r_1 is the distance. That assigns an \mathbf{E} vector to every point in space (except at q_1 where $r_1 = 0$).

In the case of a number of point charges, n , the \mathbf{E} field is obtained by linear superposition

$$\mathbf{E} = k \sum_{k=1}^n \left[\frac{1}{r_k^2} \right] \mathbf{r}_k q_k$$

For a spread out charge distribution, summing by integration gives

$$\mathbf{E} = k \int \left[\frac{1}{r^2} \right] \mathbf{r} dq$$

Figure 2 illustrates the \mathbf{E} fields for a number of charge configurations. The Coulomb force on any charge q at a point is just $\mathbf{F}_c = q\mathbf{E}$ where \mathbf{E} is evaluated at that point.

A small charge q is used to explore the field so that it has a minimal effect upon the object it is measuring. Suppose we let q ap-

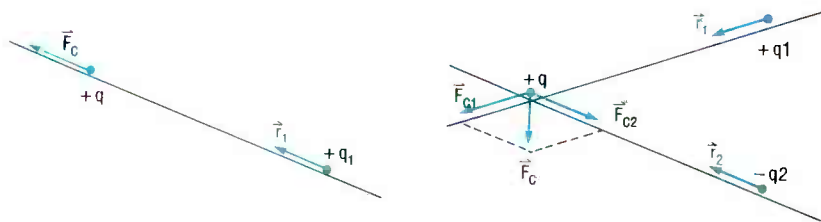

FIG. 1—COULOMB'S EXPERIMENTS showed that a static electric charge produces a force F_c on another charge. A positive-point charge $+q_1$ produces a force on another positive charge $+q$ in the direction of the unit vector \mathbf{r}_1 (a). A positive charge $+q_1$ produces a force F_{c1} on $+q$ in the direction of the unit vector \mathbf{r}_1 . A negative charge $-q_2$ produces a force F_{c2} directed opposite to \mathbf{r}_2 . The total force on $+q$ is the vector sum F_c (b).

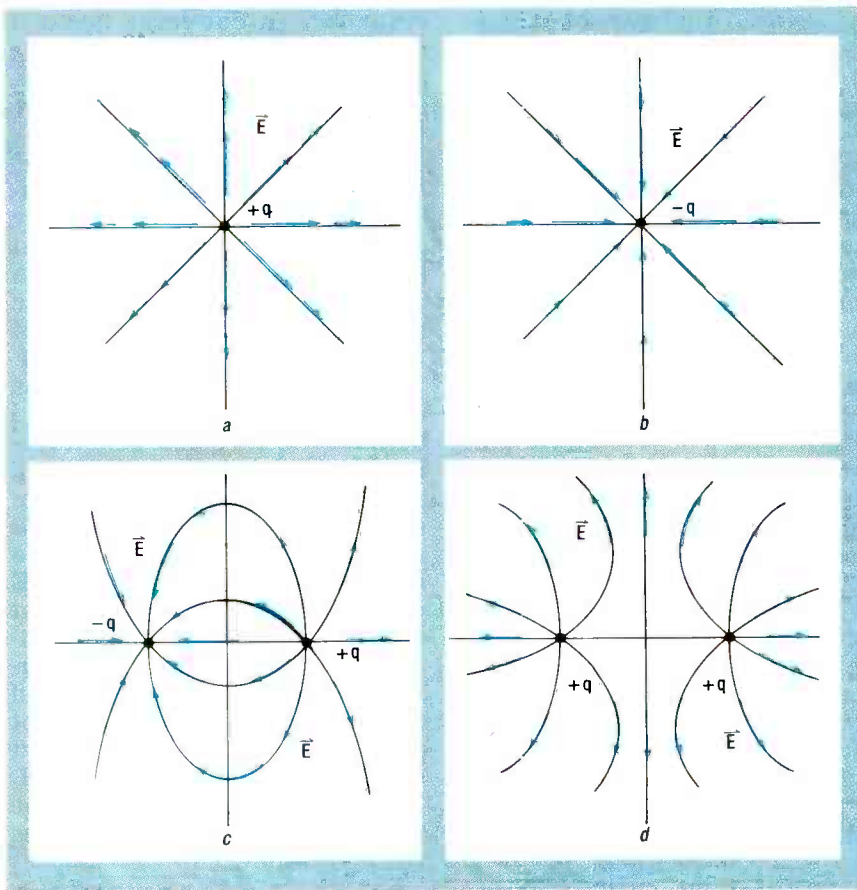

FIG. 2—THE **E** FIELD IS A RESULT OF the forces between static electric charges. Field vectors are shown in a cross section of a 3-dimensional space for a static positive-point charge (a) and for a static negative-point charge (b). In (c) and (d) the **E** fields for two static charges are shown; the vectors are located at their tail points.

proach 0. In reality, we can't vary the charge continuously since charge appears to come in multiples of e , but we can idealize the process. The force felt by that charge will decrease as the charge decreases, but the ratio of the change in force to the change in charge will reach some limiting value. That relationship is written in the calculus notation

$$\mathbf{E} = \lim_{\Delta q \rightarrow 0} \frac{\Delta \mathbf{F}}{\Delta q} = \frac{d\mathbf{F}}{dq}$$

Very small positive point charges (so small that their **E** fields can be neglected) can be thought of as ideal devices to explore the **E** field.

Field characteristics

A scalar field, as shown in Fig. 3, can be characterized by the fact that a scalar value can change by a certain amount in a particular direction. In any real field, the values differ little from one point to neighboring points. The gradient of a scalar field is a

mathematical operation. It gives a vector that points in the direction for which the value undergoes the largest change, and whose magnitude is that rate of change. The gradient of the scalar field h is symbolized by ∇h . If ∇h equals zero, then the neighboring points must all equal h

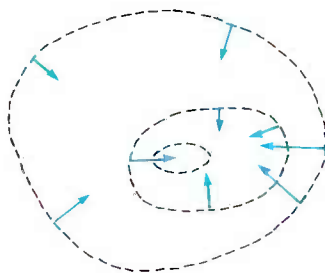

FIG. 3—THE GRADIENT OF A SCALAR FIELD is a vector field. The scalar value is the same along each dashed line called an equi-line. Each of the vectors have a magnitude proportional to the greatest rate of change in scalar value per unit distance, and point in the direction of the greatest change. The vectors are perpendicular to the equi-line at their respective points.

values. If ∇h is non-zero at a point, then the neighboring points at right angles to ∇h have the same value h .

For example, imagine standing at a point on a hillside with the height, h , at every point known. ∇h would point in the direction of maximum increase in h , and the maximum decrease would be in the opposite direction, $-\nabla h$. If you walked at right angles to ∇h at each point, you would walk along a level or equi-height line. If ∇h equals zero, you would be at a flat spot. ∇h is a vector field since it gives a vector for each point.

Vector fields can be characterized by the fact that they give the impression of flow, as shown in Fig. 4-a-e. In general, near any point the apparent flow diverges away from (or toward) the point, rotates or curls around a point, or is a combination of both. If the field describes a material, such as air velocity, then there is an actual flow of material.

To measure the apparent flow, or spreading out of the **E** field from a point, imagine an arbitrary closed surface, called a

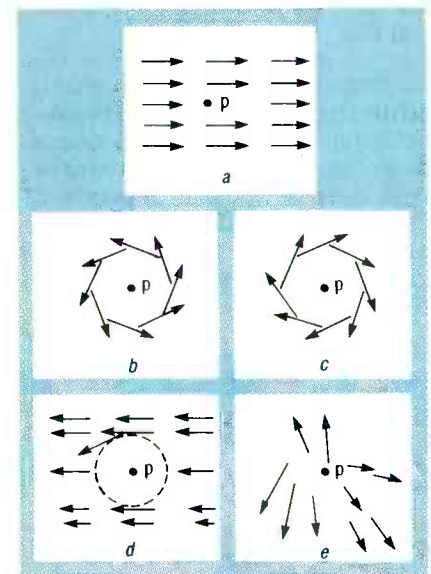

FIG. 4—VECTOR FIELDS GIVE the impression of flow that diverges from, or curls around, an arbitrary point p . Both the divergence and curl of the field are zero in (a). There is zero divergence and non-zero curl in (b); the curl is a vector out of the page at the point. In (c), the direction is reversed, and the vector points into the page. In (d) there is zero divergence but non-zero curl since there are non-symmetrical contributions around the closed line. Both the divergence and curl are non-zero in (e); these fields could not be static **E** fields.

Gaussian surface enclosing a charge q , as in Fig. 5-a. Divide the surface into an infinite number of infinitesimal surface areas ds . Area is a vector because it has a magnitude and also a direction, or orientation in space which is taken as normal (perpendicular) to the surface, and pointing outward away from the enclosed volume. Each infinitesimal area is essentially a small plane with an \mathbf{E} vector through it. Because the surface is arbitrary, each ds and its \mathbf{E} vector does not have to be parallel. In other words, \mathbf{E} may not be normal to the plane.

To find the apparent outflow, we need to consider only the component of \mathbf{E} normal to the plane; the rest is just flowing over the surface. The scalar, or dot product, $\mathbf{E} \cdot ds$, does that by giving the product of the magnitude of \mathbf{E} parallel with ds times the magnitude of ds . That is the same as the product of the magnitude of the effective area (the projected area with ds parallel to \mathbf{E}) times the magnitude of \mathbf{E} . The apparent flow is electric flux. Summing the contributions from each ds over the entire surface gives the total flux

$$\psi = \int \mathbf{E} \cdot ds \text{ (N/C m}^2\text{)}$$

ψ is proportional to the charge q within the volume since \mathbf{E} is proportional to q . Because \mathbf{E} obeys the $1/r^2$ law, and the effective area obeys the r^2 law, ψ is independent of the surface. If a number of point charges were contained inside the volume, ψ would be proportional to the total charge

because the total \mathbf{E} field is the linear superposition of their \mathbf{E} fields. The proportionality constant is $1/\epsilon_0$, therefore

$$\psi = q/\epsilon_0$$

Charges outside the volume would not contribute to the \mathbf{E} field. The reason for that is if some \mathbf{E} came in through some ds 's, it would go out through some other ds 's in just the right amounts to cancel out because of the $1/r^2$ and r^2 dependence. Graphically, lines having the direction of \mathbf{E} at each point, and with their closeness proportional to ψ are sometimes used to depict the \mathbf{E} field. That's a convenient approach, but it must be remembered that the \mathbf{E} field is actually a vector at each point in space.

If the Gaussian surface shrinks down to a point, then all the ds 's would shrink to zero and so would flux ψ . The ratio of the change in flux to the change in volume as the surface shrinks reaches a limiting value. That limiting value is called the divergence, and is symbolized by

$$\nabla \cdot \mathbf{E} = d\psi/d_{\text{volume}}$$

That must be proportional to the charge per unit volume

$$dq/d_{\text{volume}} = \rho,$$

which is called charge density within the surface, therefore

$$\nabla \cdot \mathbf{E} = \rho/\epsilon_0 \text{ (N/C m)}$$

Since ϵ_0 is a constant and is independent of the volume, the above equation could be written as

$$\nabla \cdot \epsilon_0 \mathbf{E} = \rho$$

A number of \mathbf{E} field instruments (small $+q$'s) scattered around a region, would diverge away from a positive charge (a positive di-

vergence) or converge upon a negative charge (a negative divergence). A field with zero divergence cannot start or end at the point.

The apparent rotation of the \mathbf{E} field around a point can be measured by imagining an arbitrary closed curve, called an amperian loop, of length l , encircling a charge q as in Fig. 5-b. Divide the loop into an infinite number of infinitesimally small lengths, $d\mathbf{l}$. The direction of $d\mathbf{l}$ is taken as counter-clock wise. A loop is used because the $d\mathbf{l}$'s define general directions around q , whereas for a surface, the ds 's define general directions away from q . Each $d\mathbf{l}$ is so small that it is essentially a straight line segment with an \mathbf{E} vector through it. The apparent rotation at each $d\mathbf{l}$ is the magnitude of the component of \mathbf{E} , parallel to $d\mathbf{l}$ times the magnitude of $d\mathbf{l}$. We must again use the dot product $\mathbf{E} \cdot d\mathbf{l}$ to allow for the fact that \mathbf{E} may not be parallel to $d\mathbf{l}$. That gives the magnitude of the \mathbf{E} component parallel to $d\mathbf{l}$ times the magnitude of $d\mathbf{l}$.

Imagine moving around the loop, summing up $\mathbf{E} \cdot d\mathbf{l}$ to obtain the total apparent rotation, or electric circulation. Since \mathbf{E} points radially along \mathbf{r} , the only place $\mathbf{E} \cdot d\mathbf{l}$ is non-zero is where $d\mathbf{l}$ has a component parallel to \mathbf{r} . But the entire loop is closed, so for any amount it moves out radially, it must at some place move that same amount inward. The field is symmetrical, therefore whenever $\mathbf{E} \cdot d\mathbf{l}$ is positive along some $d\mathbf{l}$'s, it is negative by the same amount along other $d\mathbf{l}$'s, with a net result of zero. In calculus notation

$$\oint \mathbf{E} \cdot d\mathbf{l} = 0$$

The circle on the integration symbol reminds us that the loop is closed. Again, by linear superposition, that is true for any static charge configuration.

If the amperian loop shrinks down to a point, all the $d\mathbf{l}$'s would shrink to zero, and so would $\oint \mathbf{E} \cdot d\mathbf{l}$ (even if it weren't already zero). But the ratio of the change in $\oint \mathbf{E} \cdot d\mathbf{l}$ to the change in the enclosed area as the loop shrinks reaches a limiting value. That limiting value is called the curl, and is symbolized by

$$\nabla \times \mathbf{E} = d(\oint \mathbf{E} \cdot d\mathbf{l})/d_{\text{area}}$$

The curl is a vector, since area is a vector. It's direction is taken as

continued on page 79

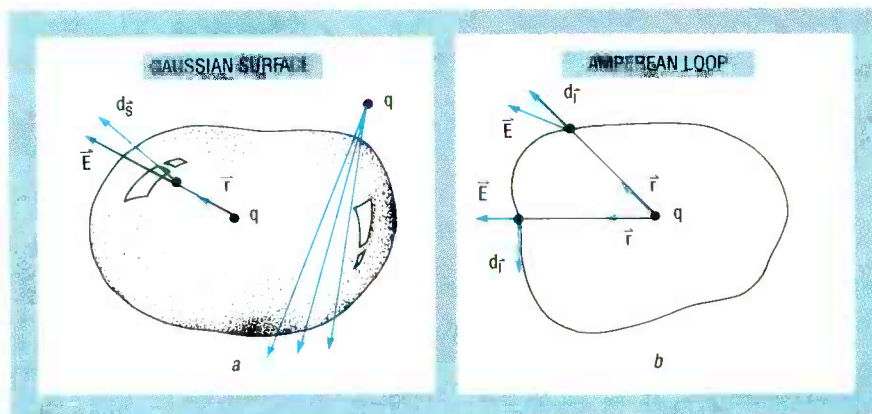

FIG. 5—CHARACTERISTIC OF AN \mathbf{E} FIELD. In (a) a Gaussian surface composed of an infinite number of infinitesimal areas ds surrounds a positive charge q . The total apparent flow of the electric field and the electric flux is the sum of $\mathbf{E} \cdot ds$ over the entire surface, which is proportional to q . Flux from charges outside the surface does not contribute because whatever flux "flows" through the surface must also flow back out. In (b), an amperian loop composed of an infinite number of infinitesimal lengths, $d\mathbf{l}$, encircles the charge. The electric circulation around the loop $\oint \mathbf{E} \cdot d\mathbf{l}$ is zero.

Focused X-ray breakthrough, C-60 and the new Buckyballs, electric power research info, getting telephone information, and caller number delivery secrets.

DON LANCASTER

Let us start off with a few updates to the infrared people detectors we looked into a column or two ago. It seems *Amperex/Phillips* decided to jump ship and abandon their line of IR detectors. Their great ap notes seem to have been discontinued. Several remaining pyroelectric detector chip samples are supposed to still be available through their sales support line (401-762-3800).

On the other hand, people detectors have suddenly become a low-cost commodity. So much so that it is now usually cheaper to buy retail and modify, rather than building your own motion sensor up from scratch. Especially when you factor in the critical *Fresnel* lens design. One cause for the sudden price drop is a new California law which mandates these on nearly every light switch in new office building construction.

Herbach and Rademan offers a great ready-to-install infrared people detector as #TM90SE1491 for \$12.50. And the *Heathkit* folks have several new occupancy and intrusion detector variations in their free home-security electronics catalog. Or, you might also want to check your local price club or warehouse builder's supply outlet.

A reminder that we have a great help line available for tech questions, off-the-wall networking, and useful consultant referrals. All per the box below. And please remember that we are using California time during the summer. Those 4:30 AM calls tend to get just a tad old. And please, please *carefully* read the *entire* column, especially the *Names and Numbers* sidebar.

Oh yeah—please note the French mathematician's name is "Fre'-nell," not "fresh-nell." And, of course, the correct pronunciations found on our ongoing voice helpline are "hee-lah" and "ten-ah-hah."

Our biggie for this month involves telephone caller identification chips

and standards. But, first, let's find out how you go about...

Getting telephone information

Contrary to popular belief, it's real easy to get full technical details on nearly everything that involves the telephone company. All you have to do is ask them.

There is a great publication known as the *Bell System Technical Journal* that has been around for over 60 years now. Included are full details on just about everything involving telephone hardware and software. Check almost any large technical library for your access. There's also the *Bell System Record*, but it focuses more on nontechnical policy issues.

For ongoing telephone standards and tutorial information, start out with the no-charge *Bellcore 1991 Catalog of Technical Information*. Then order the individual papers you want. These do tend to be a tad on the pricey side, with \$20 to \$90 being typical. VISA orders are accepted with one-week delivery. Sorry, but I don't know of any library that has a full set of these to loan out. Please let me know if you find a lower-cost access source. The library obviously screams to be made available on CD ROM.

Caller number delivery

Most of your telephone operating companies are now in the midst of upgrading to a totally digital system that includes a number of new CLASS services. By far the most popular new service is known as

Caller Number Delivery, which can show you who is calling you before you pick up your telephone handset.

Caller number delivery does appear rather controversial. But, for most people most of the time, knowing who is calling you is infinitely more important than protecting people's "rights" to make undetected obscene phone calls. Very sadly, at least one state (Pennsylvania) has stupidly banned this wonderful new service. In other areas, the caller is given the option of blocking their caller ID, for those one-in-a-thousand calls when your anonymity might legitimately be desired. Maybe for a drug overdose hotline. Blocking can get done by entering a three-digit code before you make your call.

So what is caller ID, and how does it work?

Figure 1 shows you some of the more interesting Bellcore documents that involve caller ID. But the key horse's-mouth paper you'll need is Technical Reference TR-TSY-00030 and titles *SPCS Customer Premises Equipment Data Interface*. The cost is \$25 via VISA.

Figure 2 shows you the exact placement of the tone codes. Caller number delivery is normally provided as a code burst between the first and second *full* rings while your phone is still on its hook. Enough delay is provided to allow for the short half-second breaks sometimes involved in selective ringing.

After your first full ring gets detected, a data path is established. A data path is simply any method of receiving some modem tones. The ID tones are then routed to suitable circuitry to recognize the data burst and strip out the needed information. The format and codes are related to the digital codes used in pagers.

The tones sent out are plain old serial binary modem tones at 1200 baud. A digital logic one (or a *mark*) is defined as one cycle of a 1200-Hz sine wave. A digital logic zero (or a

NEED HELP?

Phone or write your **Hardware Hacker** questions directly to:
Don Lancaster
Synergetics
 Box 809
 Thatcher, AZ 85552
 (602) 428-4073

space) is defined as nearly two cycles of a 2200-Hz sine wave. Each eight-bit character is preceded by a space start bit and a mark stop bit.

The transmitted signal level is -13.5 dBm. While the code transmission is asynchronous, phase coherence is preserved throughout the entire caller ID message. No more than 20 marks are permitted between characters.

Figure 3 shows you the data format. It might appear fairly complicated at first, but making sure the number is valid is quite important. Almost certainly, you will elect to use a computer, or at the very least, some simple microcontroller in your caller-ID display circuitry.

The first thing sent is called the *channel seizure signal*. That consists of 30 bytes of a Hex \$55 code. After decoding, another way to look at this "hey wake up!" signal is one quarter second of a 600-Hz square wave.

After the channel seizure signal, a carrier signal is sent. It's used to condition your receiver for valid data. The carrier consists of at least 150 milliseconds worth of marks. After the decoding, you have a one-sixth second

1. NYNEX Catalog of Technical Information, #NIP-7400, Free.
2. SPCS Customer Premises Equipment Data Interface, #TR-TSY-0030, \$25.
3. CLASS Feature: Calling Number Delivery #FSD-02-1051, \$30.
4. CLASS Feature: Calling Number Delivery Blocking #TR-TSY-000391, \$33

The main Bellcore service number is (800) 521-CORE.
Of these resources, (2) is by far the most important.

FIG. 1—HERE'S THE KEY INSIDER SECRET PAPERS involved with telephone system caller number delivery.

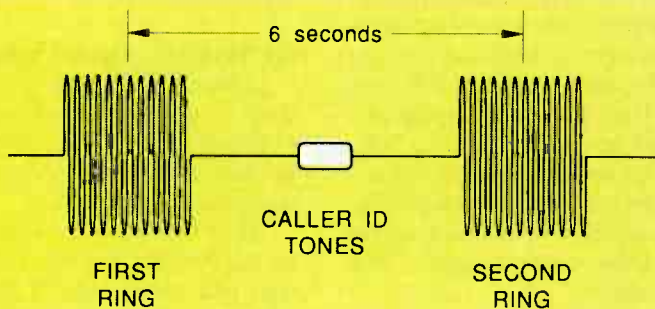
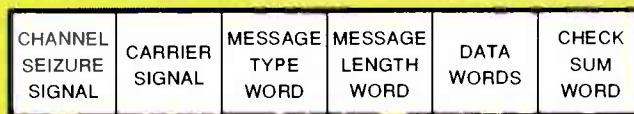

FIG. 2—THE CALLER ID DATA BURST is sent between the first and second rings as shown. The transmitted level is -13 dBm and enough delay is provided to allow for distinctive ringing patterns. A typical number ID will take half a second. The phone must remain on hook while the ID is being received.



The **CHANNEL SEIZURE SIGNAL** is made up of a string of 30 bytes of Hex \$55, and is equivalent to 250 msec. of a 600 Hertz square wave.

The **CARRIER SIGNAL** consists of 150 milliseconds of marks, equal to digital logic ones.

The **MESSAGE TYPE WORD** is a Hex \$04 when providing for the identification of a calling number.

The **CHECKSUM WORD** is the two-complement 8-bit sum of the message length and data words. It can be used for error trapping.

The **DATA WORDS** are the actual caller ID digits in ASCII character form, least significant digit first. Each digit byte is preceded by a zero "space" start bit and followed by at least one "mark" stop bit.

The **MESSAGE LENGTH WORD** is the number of characters being provided as the calling number.

FIG. 3—THE DATA FORMAT for the caller ID service.

solid string of logical ones following your quarter-second burst square wave at 600 Hz.

Your caller-ID receiver circuitry is supposed to use this "wake up call" and string of marks to prepare itself for valid data reception. After setup, the first valid data byte is called a *message type word*. If that burst is for the caller number delivery, your message type word will be a hex \$04. Other codes could get used for other

purposes. For instance, a hex \$0A means "message waiting" for pager applications.

The next byte is called the *message length word* that tells you how many digits are to be provided in the caller ID numbers that are to follow. The message length does *not* include itself or the checksum in its count.

The actual ASCII characters for the caller phone number follow, starting

**NEW FROM
DON LANCASTER**

HARDWARE HACKER STUFF

| | |
|------------------------------------|--------|
| Hardware Hacker Reprints II or III | 24.50 |
| Midnight Engineering Reprints | 16.50 |
| Incredible Secret Money Machine | 12.50 |
| CMOS Cookbook | 24.50 |
| TTL Cookbook | 19.50 |
| Active Filter Cookbook | 19.50 |
| Micro Cookbook vol I or II | 19.50 |
| Lancaster Classics Library | 109.50 |
| Enhancing your Apple I or II | 17.50 |
| AppleWriter Cookbook | 19.50 |
| Absolute Reset IIe & IIc | 19.50 |
| Enhance I or II Companion Disk | 19.50 |
| AppleWriter CB or Assy CB Disk | 24.50 |

POSTSCRIPT STUFF

| | |
|------------------------------------|--------|
| Ask The Guru Reprints I, II or III | 24.50 |
| LaserWriter Secrets (IIe/Mac/PC) | 29.50 |
| PostScript Show & Tell | 39.50 |
| Intro to PostScript VHS Video | 39.50 |
| PostScript Beginner Stuff | 39.50 |
| PostScript Cookbook (Adobe) | 16.50 |
| PostScript Ref. Manual (Adobe) | 22.50 |
| PostScript Program Design (Adobe) | 22.50 |
| Type I Font Format (Adobe) | 15.50 |
| LaserWriter Reference (Apple) | 19.50 |
| Real World Postscript (Roth) | 22.50 |
| PostScript Visual Approach (Smith) | 22.50 |
| Thinking in PostScript (Reid) | 22.50 |
| The Whole Works (all PostScript) | 299.50 |

FREE VOICE HELPLINE VISA/MC

SYNERGETICS
Box 809-RE
Thatcher, AZ 85552
(602) 428-4073

NAMES AND NUMBERS

Bellcore

445 South Street, Room 2J-125
Morristown, NJ 07926
(201) 829-4785

CIRCLE 301 ON FREE INFORMATION CARD

Communications Specialists

426 West Taft Avenue
Orange, CA 92665
(800) 854-0547

CIRCLE 302 ON FREE INFORMATION CARD

Dialog Information Services

3460 Hillview Avenue
Palo Alto, CA 94304
(415) 858-2700

CIRCLE 303 ON FREE INFORMATION CARD

Electric Power Research Ins.

3412 Hillview Avenue
Palo Alto, CA 94304
(415) 855-2000

CIRCLE 304 ON FREE INFORMATION CARD

GEne

401 North Washington Street
Rockville, MD 20850
(800) 638-9636

CIRCLE 305 ON FREE INFORMATION CARD

Herbach & Rademan

401 East Erie Avenue
Philadelphia, PA 19134
(215) 426-1700

CIRCLE 306 ON FREE INFORMATION CARD

Materials & Electrochem Res.

7960 South Kolb Road
Tucson, AZ 85706
(602) 574-1980

CIRCLE 307 ON FREE INFORMATION CARD

Meridian Data

5615 Scotts Valley Drive
Scotts Valley, CA 95066
(408) 438-3100

CIRCLE 308 ON FREE INFORMATION CARD

Mouser Electronics

11433 Woodside Avenue
Santee, CA 92071
(800) 346-6873

CIRCLE 309 ON FREE INFORMATION CARD

National Semiconductor

475 Ellis Street
Mountain View, CA 94043
(213) 323-3923

CIRCLE 310 ON FREE INFORMATION CARD

Power Quality

2742 Eastman Avenue #33-34
Ventura, CA 93003
(805) 650-7070

CIRCLE 311 ON FREE INFORMATION CARD

Satco

924 South 19th Avenue
Minneapolis, MN 55404
(800) 328-4644

CIRCLE 312 ON FREE INFORMATION CARD

SGS-Thomson

100 East Bell Road
Phoenix, AZ 85022
(602) 867-6259

CIRCLE 313 ON FREE INFORMATION CARD

Sierra Semiconductor

2075 North Capitol Avenue
San Jose, CA 95132
(408) 263-9300

CIRCLE 314 ON FREE INFORMATION CARD

Synergetics

Box 809-RE
Thatcher, AZ 85552
(602) 428-4073

CIRCLE 315 ON FREE INFORMATION CARD

VSI Telecommunications

9329 Douglas Drive
Riverside, CA 92503
(800) 999-8232

CIRCLE 316 ON FREE INFORMATION CARD

with the least significant digit. For instance, a digit "2" should get ASCII coded as hex \$32.

Your message ends with a *checksum word* used for optional error detection. The checksum is the two's complement of the 8-bit sum of the message type word, your message length word, and the number of data words provided. To provide an error detection, you run your own 8-bit sum of all the bits of all the data

words, and then add the checksum to it. If there are no transmission or reception errors, you should get a zero result. A non-zero result means an irrecoverable error.

I've just described the *single data message format* to you. Some nasty complications can arise if you have multiple data messages or several CLASS services active, such as call waiting. See the Bellcore info for further details.

There are a number of caller ID devices commercially available, with pricing in the \$60 to \$500 range. Typical are the *Allied incoming call identifier*, the *Bellsouth calling line identifier*, the *Cidco Slimline* series, and the TC-1021, TC-1080, and the TC-1082. One discount source of all these is *VSI Telecommunications*.

Do note that your caller number delivery service must be provided to you before you can use any of these devices. If the code is not being sent, there is no way you can receive it. There might be certain state laws prohibiting their use as well. That, of course, can be cured by staking your state representative to the nearest anthill. Finally, anything you connect to the telephone line has to be FCC Type 68 approved. Meeting the rules for type approval is fairly reasonable and simple. But the approval process itself is a bear.

We do have several experimental caller ID projects in the works here at **Radio-Electronics**, along with some simulator and test software. But there are ongoing problems with service availability, with meeting FCC part 68 specs, and in keeping the price low enough. Probably some absolute minimum general purpose caller ID interface kit that *demands* use of a personal computer programmed in machine language to develop your own circuits makes the most sense at this time. Let us know what you want to see here.

A caller-ID chip

As Fig. 4 shows us, there are usually four stages to the caller ID receiver. The first stage is called an *FCC Part 68 Interface*. That is needed to safely and legally connect to your phone system. Full details on Type-68 interface secrets appear in the *Hardware Hacker II* reprints.

The second stage is the *analog front end*. The analog front end provides filtering and amplification, and converts all of your tones into actual TTL ones and zeros.

Figure 5 shows you an analog front-end circuit that uses the brand new *Sierra Semiconductor SC11211N* caller-ID chip. You input the low-level telephone tones and get out a serial data stream ready for computer or microcontroller interpretation. Inside the chip is a fancy filter, an energy detector, a tone demodulator, and a clock. An ordinary TV color crystal

and four capacitors is all you need to use this circuit. Cost for the 16-pin mini DIP is in the \$4 range in small quantities.

There's also a fancier SC11210 chip fabricated in a smaller package that deletes the internal crystal oscillator, the level setting, and all of the energy-detection features. Sierra also has ap notes on suitable FCC part-68 interfaces.

While these chips are low in cost and work rather well, note that they are *only* analog front ends. "All" they do is reliably accept low-level tones from the part 68 interface and then convert them into a string of digital ones and zeros.

The third ID stage is the *number extractor*. The number extractor takes the serial data stream, makes sure it's valid, and then extracts and formats the calling number. The number might also be displayed. The number extractor almost has to be a computer or microcontroller, since it probably would be unbearably complicated and expensive otherwise.

The final and optional stage is any "gee whiz" stuff. Things like looking up the actual name of the caller. Or pulling their sales or service records. Or keeping a full record of the last hundred calls. Or interacting with a humongous CD-ROM data base. Once again, be sure to let us know what you want to see in the way of further caller-ID projects.

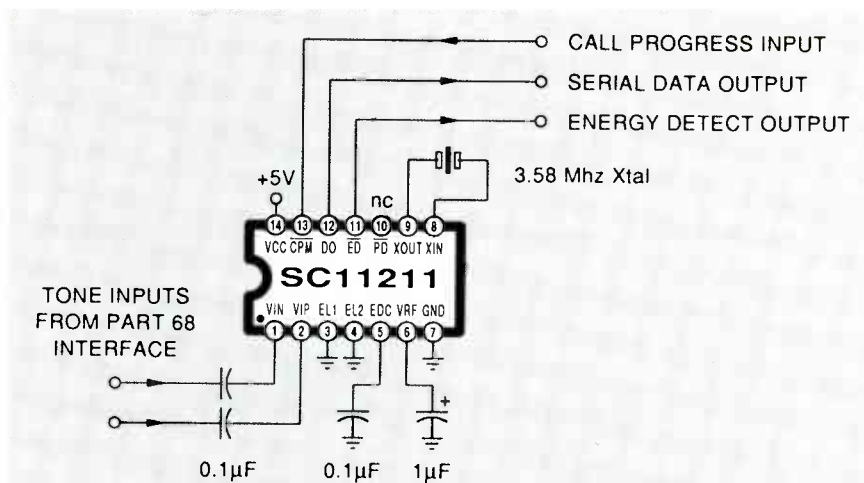

FIG. 5—A CALLER ID ANALOG FRONT END that uses the Sierra Semiconductor SC11211 chip. Low-level tones are accepted from the FCC Part 68 interface and get converted into serial ones and zeros for further digital processing.

Buckyballs and C60

Carbon is one of the more interesting chemical elements. It forms the basis of all life as we know it. And, because of some energy and bonding restrictions, carbon quite possibly will also turn out to be the basis of all life as we don't know it. Carbon is also the key to most fuels, plastics, and foods. It bonds readily with many other elements, creating by far the richest assortment of useful chemical compounds.

Until recently, there were only two known forms for any pure carbon molecules. These were the supersoft graphite and superhard diamond. But several chemists (Kroto, et al. *Nature* v318 p162, 1985) have discovered a uniquely bizarre third form of carbon molecule. By taking 20 hexagonal groupings of six carbon atoms and then fusing them properly with 12 pentagonal groupings of five carbon atoms, a *hollow* geodetic pure-carbon molecule consisting of 60 atoms gets created.

Since this hollow all-carbon C-60 molecule looks like a geodetic dome or a soccer ball, they were promptly given the name of *Buckyballs*, named after the late Buckminster Fuller, a leading early proponent of geodetic dome structures.

Initially a few C-60 molecules were painfully hand collected, measured, and tested. And, sure enough, C-60 is for real. An experimental proof of the Buckyball shape has just recently appeared (Hawkins, et al., *Science*, v252, p312), along with a very fine bibliography.

After the discovery, several other chemists (Kratschmer, et al. *Nature*

v347 on p354, 1990) were playing around with carbon rods in a plain old arc welder and figured out how to make lots of Buckyballs in a process almost as complicated as smoking a piece of glass with a candle.

As a result, the price of Buckyballs has plummeted to an astonishingly low \$1200 per gram. Quantity pricing is even less, and 100 milligrams of Buckyballs are available for \$250 if you are on a limited budget. You can get all the Buckyballs you want off the shelf from *Materials and Electrochemical Research*.

The latest games include putting Osmium "handles" on a Buckyball to make them easier to align, and adding precise doping impurities to create several new families of "Dopeyballs."

While nobody has yet come up with a proven commercial use for Buckyballs, they are now by far the hottest topic in physical chemistry. Buckyballs will even superconduct, although only at rather low temperatures so far. The hollow molecule suggests all sorts of stunning new possibilities which include super lubricants, new batteries, ultra-strong fibers, improved semiconductors, and entire new classes of materials and compounds.

Needless to say, Buckyballs are a sure-fire winner for a Science Fair topic or school research paper. And we here at **Radio-Electronics** would certainly be most interested in any Buckyball project that's even remotely related to electronics. Let us know what you can do here.

Ongoing info on Buckyballs will appear in those *Science* and *Nature*

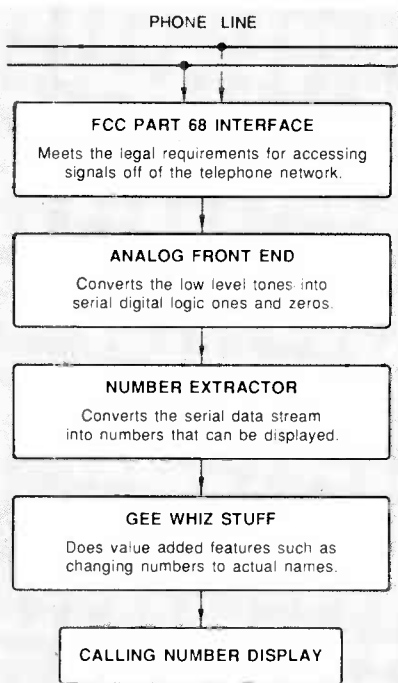

FIG. 4—THE FOUR STAGES INVOLVED in a calling number ID display.

New! NRI course in Cellular Telephone Installation and Servicing prepares you to succeed in today's fastest-growing communications field

Now you can get the skills you need to cash in on today's booming cellular industry as you install and test your own state-of-the-art cellular telephone.

Cellular business is big business!

In the few short years since the first commercial cellular telephone system went on-line, over 1,000,000 people have signed up for service in more than 120 cities nationwide. Today, the industry is growing at an incredibly fast 4% a month, and experts predict that by 1991, at least 85% of the United States will be covered for cellular service. Better yet, by 1993 total industry revenues will exceed \$10,000,000,000—making cellular the fastest growing electronics communications field today.

For you, that means extraordinary career and money-making opportunities. Get a fast start today with NRI's hot new course in Cellular Telephone Installation and Servicing. See how far you can go!

Help wanted! Urgent demand for field technicians who can install and test new cellular telephone equipment!

Get the skills, knowledge, and confidence to install and test cellular telephone equipment, and you can name your price in this exploding new job market. Cellular system developers, retailers, and service providers—all on the ground floor of an industry that's still so young and growing so fast—are all willing to pay a premium for anyone trained to service this brand-new equipment.

Now, with NRI, you can take full advantage of every exciting opportunity in today's—and tomorrow's—booming field of cellular communications.

Exclusive hands-on training includes high-performance mobile cellular telephone you keep

Your NRI course starts with the electronics fundamentals you need to understand and service all telephone systems, then walks you step by step through the installation, troubleshooting, and repair of popular telephone systems in use today.

But that's just the beginning. With a solid conventional phone servicing foundation behind you, you're ready to build your expert understanding of the cellular telephone systems moving fast into communities all over the U.S.

Following complete, easy-to-read guidelines, you install a full-featured mobile cellular telephone in your own car, then take it through a series of diagnostic tests to become fully acquainted with its operating functions. Best of all, if you live in an area already offering

Includes full-featured mobile cellular telephone you keep!



10-digit luminescent display with 24-digit number entry/review

Ignition sense automatically turns your phone on and off with car's ignition

Electronic lock prevents unauthorized use of your phone

22 memories including last number called

Super speed dialing and 1 digit recall

cellular coverage, NRI will help you actually go on-line with up-to-date, expert advice on choosing the best and most affordable cellular service available.

Send for your FREE catalog today

For all the details about NRI's exclusive new training, send the coupon today. You'll receive a complete catalog describing NRI's Cellular Telephone Installation and Servicing course plus NRI courses in other high-tech, in-demand fields.

If the coupon is missing, write to NRI School of Electronics, McGraw-Hill Continuing Education Center, 4401 Connecticut Avenue, Washington, DC 20008.

Send Coupon Today For Free Catalog!

NRI School of Electronics

McGraw-Hill Continuing Education Center
4401 Connecticut Ave, Washington, DC 20008



For career courses approved under GI Bill
 check for details.

CHECK ONE CATALOG ONLY

- | | |
|--|---|
| <input type="checkbox"/> Cellular Telephone | <input type="checkbox"/> Data Communications |
| <input type="checkbox"/> Computer Electronics | <input type="checkbox"/> Security Electronics |
| <input type="checkbox"/> TV/Video/Audio Servicing | <input type="checkbox"/> Robotics |
| <input type="checkbox"/> Electronic Music Technology | <input type="checkbox"/> Basic Electronics |

Name _____ Age _____

Street _____

City/State/Zip _____

Accredited Member National Home Study Council

3-081

magazines, and, of course, through the *Dialog Information System*.

EPRI

The Electric Power Research Institute is a rather low-key research consortium. You have to be a power company to join them. Even then, their annual membership fees are astronomical. But, with their \$400 million annual budget they now do all sorts of top-quality energy research, including thorough coverage of such subjects as solar power, efficient lighting, cogeneration, conservation, environmental quality, cold fusion, and alternate energy sources. Plus, of course, nasty old nuke stuff.

EPRI does have plenty of videos, technical reports, papers and such available. They also have products for licensing. The summary report of most of their recent key papers costs \$45. You might like to contact them directly for further info.

New tech literature

A new method of focusing X-rays known as a *Kumhakov lens* is now described on page 208 of *Science* volume 252. If it proves as good as it looks, this could revolutionize every-

thing from high-density integrated circuits to safer dentistry. The lens consists of scads of glass capillaries, and the X-rays skip along the surfaces at low angles, rather than shooting right on through them.

From *National Semiconductor*, a new *General Purpose Linear Devices* data book. And from *SGS-Thomson* a new *Power Transistors Application Manual*. Good stuff.

Satco is a great source for oddball tools and supplies. They usually sell to those school vocational education programs. They do have a great new thousand-page catalog available.

Unusual scientific images of all sorts of geologic, oceanographic and atmospheric stuff is available on a GRIPS-2 CD-ROM from *Meridian Data*. It is part of a new program to release obscure government research to a wider audience.

Our unusual trade journal of the month is *Power Quality*, aimed at the higher-end users of uninterruptable power supplies.

Chip capacitors and resistors for surface mounting are now finally becoming widely available in small quantities at sane pricing. While *Mouser Electronics* is a good source, some

ready-to-go \$49.95 resistor and capacitor kits are available through *Communications Specialists*. That's three cents each for the resistors and fourteen for the caps.

Turning to my own products, for the fundamentals of digital integrated circuits, do check out my *TTL Cookbook* and *CMOS Cookbook*. Or you can pick up all of those "oldies but goodies" all at once in my *Lancaster Classics Library*.

I also have a BBS up as *GENie PSRT*. Besides all the PostScript and desktop publishing stuff, you'll find all sorts of ongoing *Hardware Hacker* and *Midnight Engineering* resources here. You can get your voice connect info by dialing (800) 638-9636.

We also now have the *Hardware Hacker III*, *Ask the Guru III*, and the new *Midnight Engineering I* reprints available, which have the latest and best of all these columns in them. All edited, revised, and indexed.

Finally, I do have a new and free mailer for you that includes dozens of insider hardware hacking secret resources. Write or call for info. Our usual reminder here that most of the items mentioned appear in the *Names and Numbers* sidebar. **R-E**

FCC NO-CODE AMATEUR RADIO LICENSE

The FCC recently passed Docket 90-55 which for the first time allows a new codeless entry ham radio license of technician grade. Privileges 30 MHz and above — All modes! (See R.E. article in April 1991 issue).

Get all the no-code license details, study & testing information plus a one-year subscription to one of ham radio's longest running specialty mode publications that will teach you all about the new modes you will be able to operate!

FSTV SSTV FAX RTTY PACKET AMTOR OSCAR FM REPEATERS MICROWAVE AND LOTS MORE!



The SPEC-COM Journal
P.O. Box 1002,
Dubuque, IA 52004
(319) 557-8791

SEND \$25 CHECK OR MONEY ORDER

OUR 24TH YEAR SINCE 1967!



MC/VISA (5% added)



Be an FCC LICENSED ELECTRONIC TECHNICIAN!



No costly school. No commuting to class. The Original Home-Study course prepares you for the "FCC Commercial Radiotelephone License." This valuable license is your professional "ticket" to thousands of exciting jobs in Communications, Radio-TV, Microwave, Maritime, Radar, Avionics and more...even start your own business! You don't need a college degree to qualify, but you do need an FCC License.

No Need to Quit Your Job or Go To School This proven course is easy, fast and low cost! **GUARANTEED PASS**—You get your FCC License or money refunded. **Send for FREE facts now. MAIL COUPON TODAY!**

COMMAND PRODUCTIONS

FCC LICENSE TRAINING, Dept. 90
P.O. Box 2824, San Francisco, CA 94126
Please rush FREE details immediately!

NAME _____
ADDRESS _____
CITY _____ STATE _____ ZIP _____

LEARN VCR CLEANING/MAINTENANCE/REPAIR
EARN UP TO \$1000 A WEEK, WORKING PART TIME FROM YOUR OWN HOME!



THE MONEY MAKING OPPORTUNITY OF THE 1990'S

IF you are able to work with common small hand tools, and are familiar with basic electronics (i.e. able to use voltmeter, understand DC electronics)... IF you possess average mechanical ability, and have a VCR on which to practice and learn... then we can teach YOU VCR maintenance and repair!

FACT: up to 90% of ALL VCR malfunctions are due to simple MECHANICAL or ELECTRO-MECHANICAL breakdowns!

FACT: over 77 million VCRs in use today nationwide! Average VCR needs service or repair every 12 to 18 months!

Viejo's 400 PAGE TRAINING MANUAL (over 500 photos and illustrations) and AWARD-WINNING VIDEO TRAINING TAPE reveals the SECRETS of VCR maintenance and repair—"real world" information that is NOT available elsewhere!

Also includes all the info you'll need regarding the BUSINESS-SIDE of running a successful service operation!

FREE INFORMATION
CALL TOLL-FREE 1-800-537-0589
Or write to: Viejo Publications Inc.
5329 Fountain Ave.
Los Angeles, CA 90029 Dept. RE

CIRCLE 176 ON FREE INFORMATION CARD

DRAWING BOARD

A PC board for our audible logic probe.

ROBERT GROSSBLATT

Some things are enjoyable and some things aren't. This is true in life and it's just as true in electronics. Going through the whole process of a design—from idea to paper to breadboard—is a great exercise in brain stretching and a chance to let your subconscious do a bit of work. For a lot of people (at least judging by the things I get asked about in the mail), the real hassle starts when they finish all the development work and have to come up with a final version of whatever they have on the bench.

We've been spending the last couple of months on the development of handy dandy bench equipment and the logic probe we just finished up is a really neat piece of gear to have around when you're working on a prototype circuit. Once you put it together, you'll find that it's one of those things you'll always reach for first when you want to do some electron snooping.

That's all well and good but, even though one measure of a tool's worth is how much it can do, another important criterion is how easy it is to use. Companies that make test equipment spend a lot of money designing

the "user interface" since they know all too well that no matter how versatile their products are, if they're not convenient to use as well, people just won't buy them. The more time you spend in the electronics business, the more you'll learn that appearance and convenience is just as important as substance and power.

All this is leading up to the fact that the logic probe we designed is going to be useful only if it's conveniently packaged and securely made. And that means you can't reasonably expect it to be a permanent member of your toolkit unless you put it on a PC board. This is the part of the design process that most people dread. Laying out a board is one of the most tedious and least enjoyable activities you'll ever come across in electronics.

Because I'm a nice guy, I'm going to save you a lot of work and give you a foil pattern for the logic probe. I found the circuit so useful that I did a board for it not too long after the probe was first designed. Since it's not an overly complex circuit, it could be laid out on a single-sided board; we've printed the foil pattern here in case you want to make your own board.

If you trace the circuit as it's laid out on the board, you'll see that I made some changes to the original circuit we finished designing last time. The changes were done to make it easier to design the PC board and don't have any functional effect on the circuit. Some of the comparators have been swapped and the LED's are set up differently so it was simpler to bring their leads out to the edge of the board.

When I did the board a few years ago, I kept the board as small as possible so it could be housed in a hand-held case. I wound up making my own case for the probe but there are several companies that make suitably sized cases.

There's nothing critical about the board—none of the traces are very thin and there's plenty of room on the board to make them all at least a sixteenth of an inch thick. It's an easy board to etch with even the crudest equipment. The parts-placement diagram is shown in Fig. 1 and the only components I haven't put on the board are the switches and the speaker. If you can find a small enough speaker, you can leave space for it on the end of the board.

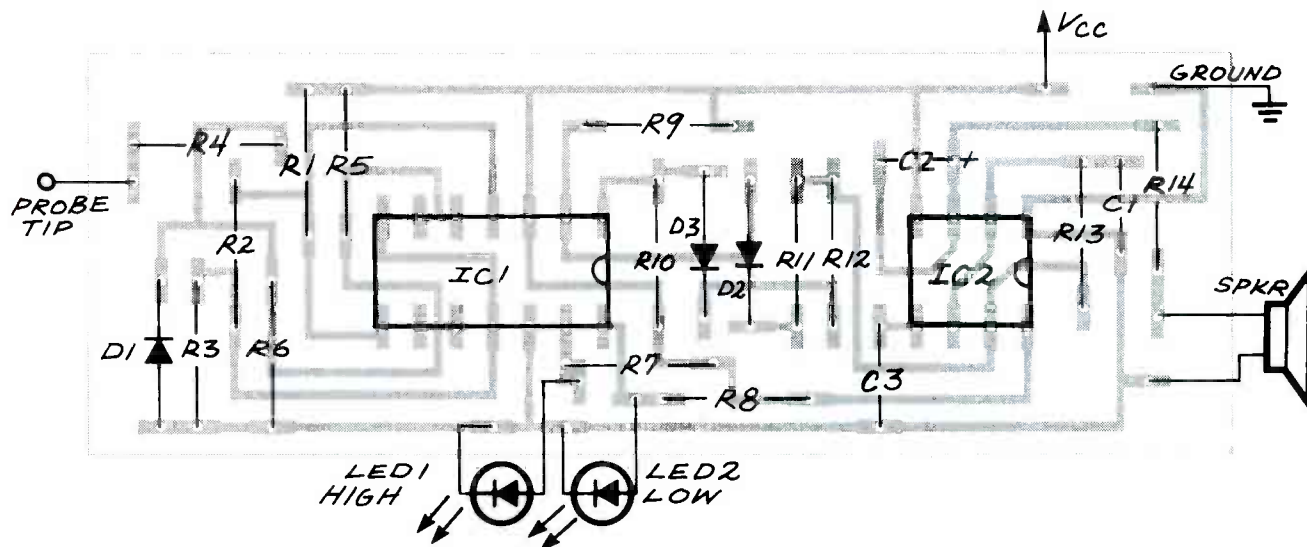

FIG. 1—PARTS-PLACEMENT DIAGRAM. The only components that aren't on the board are the switches and the speaker.

R-E Engineering Admart

Rates: Ads are 2 1/4" x 2 7/8". One insertion \$995 each. Six insertions \$950 each. Twelve insertions \$925 each. Closing date same as regular rate card. Send order with remittance to Engineering Admart, Radio-Electronics Magazine, 500-B Bi-County Blvd., Farmingdale, NY 11735. Direct telephone inquiries to Arline Fishman, area code-1-516-293-3000. FAX 1-516-293-3115. Only 100% Engineering ads are accepted for this Admart.

FCC LICENSE PREPARATION

The FCC has revised and updated the commercial license exam. The NEW EXAM covers updated marine and aviation rules and regulations, transistor and digital circuitry. THE GENERAL RADIOTELEPHONE OPERATOR LICENSE - STUDY GUIDE contains vital information. VIDEO SEMINAR KITS ARE NOW AVAILABLE.

WPT PUBLICATIONS
979 Young Street, Suite E
Woodburn, Oregon 97071
Phone (503) 981-5159 Dept. 50

CIRCLE 177 ON FREE INFORMATION CARD

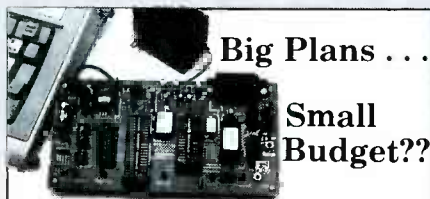

Big Plans . . .

Small Budget??

6805 Microcomputer Development System

TECI's MCPM-1 system allows your IBM PC and Compatibles to be used as a complete development system for the Motorola 6805 family of single chip microcomputers. Many time saving features at an affordable price.

MCPM-1 Programmer for Motorola MC68705P3, P5, U3, U5, R3, R5

MCPM-1 w/driver, assembler, simulator/debugger \$449
MCPM-1 w/driver program only \$349

Also available—Programmer for 68HC05, in-circuit emulators and many software tools to help you. Call for a complete catalog and let us help you select your tools



The Engineers Collaborative, Inc.
Rt #3, Box 8C Barton, VT 05822 USA

TEL: (802) 525-3458 FAX: (802) 525-3451 Call Toll Free (800) 336-8321

CIRCLE 188 ON FREE INFORMATION CARD

Surface Mount Chip Component Prototyping Kits—

Only \$49.95



CC-1 Capacitor Kit contains 365 pieces, 5 ea. of every 10% value from 1pF to .33µF. CR-1 Resistor Kit contains 1540 pieces, 10 ea. of every 5% value from 10Ω to 10 megΩ. Sizes are 0805 and 1206. Each kit is ONLY \$49.95 and available for Immediate One Day Delivery!

Order by toll-free phone, FAX, or mail. We accept VISA, MC, AMEX, COD, or Pre-paid orders. Company P.O.'s accepted with approved credit. Call for free detailed brochure.



426 West Taft Ave. · Orange, CA 92665-4296

Local (714) 998-3021 · FAX (714) 974-3420

Entire USA 1-800-854-0547

CIRCLE 196 ON FREE INFORMATION CARD

The PC board is the final touch for the probe and, if you plan on using the circuit on the bench, you should give serious thought to making it. Just about the only problems you should have are the common ones that always show up when you're making a board. These are things like solder blobs, bad joints, and backward components. You should use sockets for both the IC's. They add a bit to the

PARTS LIST

All resistors are 1/4-watt, 5%.

R1, R6, R12—100,000 ohms

R2—39,000 ohms

R3—27,000 ohms

R4—470 ohms

R5—270,000 ohms

R7—R10—1000 ohms

R11—10,000 ohms

R13—4700 ohms

R14—50—200 ohms (sets audio volume)

Capacitors

C1—0.02 µF, ceramic disc

C2—10 µF, electrolytic

C3—0.01 µF, ceramic disc

Semiconductors

IC1—LM339 quad comparator

IC2—555 timer

D1—D3—1N914 diode

LED1—red light-emitting diode

LED2—green light-emitting diode

Miscellaneous: power and input leads, speaker, perforated construction board or PC board, wire, solder, etc.

height of the board but the margin of safety they add is more than worth the extra quarter inch.

The logic probe is a good example of the kind of test equipment you can build yourself that's just as useful as similar stuff you can buy in a store. There are additions that you can make to the probe that will make it even more versatile. One that I've had in the back of my mind for years is to add a pulse detector to the circuit. It's not hard to do since the probe already has a front end that can sense logic levels.

I know myself well enough to be sure that I'll never get around to doing it but, while you have the circuit on the breadboard, it's a good time for you to think about doing it. I don't want to get into the details of the design but one of the first things that crosses my mind is that the heart of a pulse detector is a pulse generator. We already have a 555 on the board and that's one of the chips of choice to use when you want to build a pulse generator.

All you need is a bit of creative switching to convert the layout of the 555 on the board to a pulse generator that's triggered by the output of the comparator. If you really get into it, the natural way to go is to have the pulse detector produce two tones: one for a high pulse and one for a low pulse. If you don't want to fool around with switching the components on

the existing 555, you can replace the chip with a 556 and use one side of it for the original probe and the other side for the pulse detector.

If you add that feature to the probe, or if you think of something else that's particularly slick, let me know about it and I'll put it in the column. As a matter of fact, we'll make a contest out of it and the two best modifications to the circuit will win something. I need some time to figure out what that something will be—either the usual magazine subscription or something else—but I'll let you know what it is.

There's not enough room left this month to run through our next topic—a digital oscilloscope—but there is enough room for me to pass along the schematic shown in Fig. 2. It's a handy circuit that will monitor a power supply and let you know if the output voltage strays more than a half a volt away from five volts (or whatever voltage you set as the trigger).

You'll notice that the circuit has two very similar sections. The first one, the low-voltage monitor, taps the system voltage through R3 and uses the Zener voltage to keep transistor Q1 turned on. The high-voltage monitor taps the system voltage through R4 and, until the voltage is high enough for the Zener to conduct, it keeps transistor Q2 turned off.

If you use multi-turn potentiometers, you can set the low and high thresholds just about anywhere you

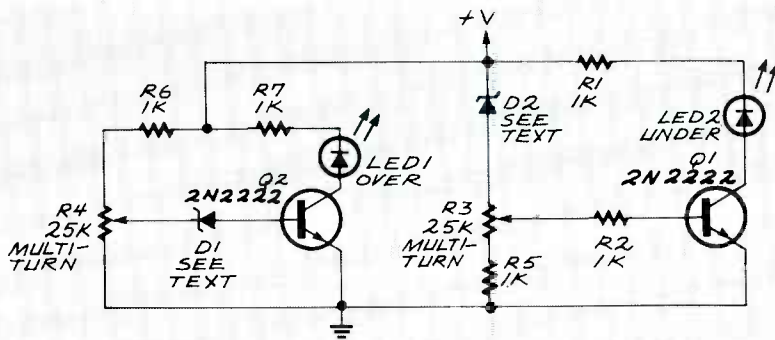
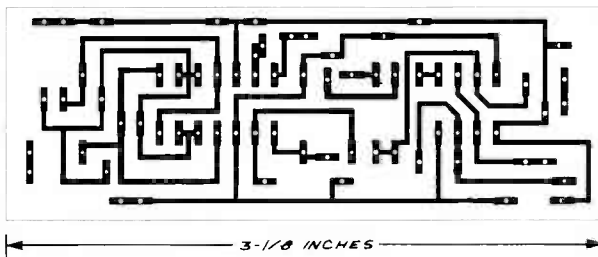

FIG. 2—THIS CIRCUIT WILL MONITOR A POWER SUPPLY and indicate whether the output voltage strays more than a half a volt away from whatever voltage you set as the trigger.



THE LOGIC PROBE CAN BE ASSEMBLED on this single-sided board.

want. For standard TTL circuits, it's best to know if the voltage is more than half a volt away from five volts but, if you're really paranoid about this kind of thing, you can trim the circuit to get even closer to five volts than that. If you want to use the circuit to keep an eye on voltages that are higher than nine volts or so, it's a good idea to replace the 4-volt Zeners shown in the schematic with something higher.

The exact threshold voltage of the diodes shown in Fig. 2 isn't important (anything around 4 volts is okay including the standard values between 3.3 and 4.3 volts) since the voltages seen by the Zeners are set by the two potentiometers. You can have the outputs of the circuit light LED's as shown in the schematic or, with a bit of work, they can trigger alarms, buzzers, relays, or whatever else you have in mind.

If you really feel like doing some design work, you can keep the idea of a voltage monitor and throw out the circuit. Remember that you can use a comparator to do the same job. The front end of the logic probe is tailor-made for an application like this but you'll have to do some arithmetic to recalculate the resistor values to set the comparator windows and make the circuit trigger on the voltages you want to monitor.

If you're not sure about how to do

that, go back over the last few columns and you'll find a complete explanation of the calculations you have to do. If there's enough interest in doing this, I'll go through the math in a future column.

Back issues of the magazine are probably in your local library but, if they're not, you can order back issues by writing to the magazine (**Radio-Electronics**, Reprint Bookstore, PO Box 4079, Farmingdale, NY 11735). 1991 back issues are \$4.00, 1990 are \$4.50, 1989 are \$4.75, 1988 are \$5.00, 1987 are \$5.25, and 1986 are \$5.50. Indicate the month and year of the issue you want; if you don't want an entire issue, or if the one you want is not in stock, you can order copies of articles for 50 cents a page. Shipping charges are \$1.25 for orders up to \$5.00, \$2.00 for \$5.01-\$10.00, \$3.00 for \$10.01-\$20.00, \$4.00 for \$20.01-\$30.00, \$5.00 for \$30.01-\$40.00, \$6.00 for \$40.01-\$50.00, and \$7.50 for orders of \$50.01 and up. New York State residents must add sales tax. Make checks payable to Gernsback Publications, Incorporated.

When we get together next time, we'll look into digital scopes and, while they don't provide the greatest resolution in the world, all the circuits that go into them happen to be very interesting. **R-E**

the direction of the extended thumb of the right hand with the fingers wrapped in the general direction taken around the loop. In the case of the static \mathbf{E} field

$$\oint \mathbf{E} \cdot d\mathbf{l} = 0,$$

therefore

$$\nabla \times \mathbf{E} = 0.$$

The curl is a vector measure of the apparent rotation of the field about a point. If a number of \mathbf{E} field instruments were scattered around a region, the group would not rotate.

The divergence and curl of the types of fields we're discussing completely characterize the field; \mathbf{E} can be found if $\nabla \cdot \mathbf{E}$ and $\nabla \times \mathbf{E}$ are known. This is known as Helmholtz's theorem.

The curl of a vector field is always zero, if, and only if the field is the gradient of some scalar field. Consider our h field example. If $\nabla \times \nabla h$ were non-zero, then in following a closed path from some point and back to the beginning, one encounters different rates of change of height times distance when taking different paths. $\oint \nabla h \cdot d\mathbf{l}$ would be path dependent. That would amount to leaving from a point at, for instance, 50 meters in elevation and returning only to find the elevation is 300 meters, or 2 meters, depending upon what path was taken!

The divergence of a field is always zero only if the field is the curl of another field. Imagine the fields of Fig. 4 in 3-dimensional space. Curl the right-hand fingers in the direction of the apparent rotation around the point. The extended thumb is the direction of the curl vector at that point. Conversely, consider the vectors shown as curl vectors. Direct the thumb along them and the fingers will curl in the direction of the field vectors. The field vectors seem to cancel, and not spread out. Those fields are the curl of another vector field. Try that with Figs. 2 or 4 and you'll get conflicting results.

Next time, we'll develop Ohm's law and look at the \mathbf{E} field in materials, which will provide further insight into Maxwell's equations. **R-E**

AUDIO UPDATE

The past, present, and future
of tape cartridges.

LARRY KLEIN

New audio/video formats are a big part of what makes life interesting for an audio journalist. I've witnessed more than a few such introductions in the 30-odd years that I've been in the business. Some "revolutionary" new product designs immediately sank without a trace, others floundered for months or years struggling to keep afloat in the marketplace, and some—such as the LP, the cassette, the VHS VCR, and the CD—went on to make it big.

What makes for new-format success? It's clear that the backing of a "big name" manufacturer is *not* sufficient. As evidence, I cite the ballyhooed—but very short-lived—RCA, 3M, and Columbia home tape cartridges, the Fidelipac car stereo cartridge, and so forth. I'm sure that other ephemeral audio and video formats come to mind for those readers who made the mistake of investing in them.

The Japanese are certainly not immune to cartridge-marketing miscalculations. The Elcaset cartridge, introduced in 1976, was backed by Sony, JVC, Technics, Teac, *et al.*, and was intended to supplant both the open-reel and Philips cassette formats. As explained to me at the time by its project engineer, it was meant to appeal to those dedicated tape buffs for whom open reel was too inconvenient and cassettes were too low in fidelity. Although the Elcaset system worked well, its projected audience didn't exist in sufficient numbers to get the product off the ground. Unfortunately, several warehouses worth of Elcaset players were ultimately scrapped.

Obviously, I'm not trying to imply that the tape-cartridge/cassette format, *per se*, is inherently unsalable. The Compact Cassette—to give it its official Philips designation—got off to a slow start in the mid-sixties but ultimately, as we know, became a huge success both for home recording and in its prerecorded form. My suspicion that the positive response to the cassette format had no necessary relationship to its fidelity—or lack of it—

was confirmed in the early 1980's. It was at that point that the annual sales of prerecorded music cassettes outstripped those of the less expensive and better sounding LP's.

If the fidelity of a format is *not* the key issue for most music buyers, what *are* consumers looking for? Convenience, durability, and reasonably low cost both for the machine and for blank and prerecorded tapes that feed them all are desirable attributes. And, of course, there has to be a wide range of popular artists available on the format. (The recent rapid replacement of the LP by the CD doesn't contradict my analysis. Sure, the CD sounds better than the LP, but the CD also is far more convenient to play, takes up much less space, and is much more durable. Furthermore, you can buy an excellent CD player at a fraction of the cost of an equivalent sounding, high-quality record player and phono cartridge.)

DAT disappointment

When the home digital-audio-tape (DAT) machine was first introduced, my initial reaction was that it was an effective and sophisticated response to an essentially minuscule demand.

There's no question that there has never been anything quite as good as DAT for the serious home recordist, for rock bands making live demo tapes, and for nature or sociological recordings. DAT's wide audio bandwidth and excellent noise, distortion, and wow and flutter levels match or exceed those of the finest studio equipment.

But is there a DAT advantage for the non-professional or the average music listener not obsessed by the need to be the first on his block to own a new product? If you were to compare a DAT recording to one made on a quality cassette deck, you would find DAT's real-world sonic advantage to be slight. And for playback in a car system, it would probably be nonexistent. That leaves longer playing time and ease of locating selections as DAT's *only* consumer advantage. Among DAT's disadvantages are the high cost of both the machine and the blank tapes, and the dearth of prerecorded tapes—possibly because of difficulties achieving high-speed duplication.

The Music Publishers Association (MPA) is still fighting for surcharges
continued on page 83



THE NEW PHILIPS DIGITAL CASSETTES will deliver CD-quality sound in a player that is compatible with standard cassettes.

COMPUTER CONNECTIONS

The friendly Amiga.

JEFF HOLTZMAN

War—or at least an intense skirmish—broke out over my response to a letter from an Amiga-phile in the April issue. A reader chided us for not publishing more Amiga-related material; I responded rather harshly. Since then numerous readers took the time to write and try to enlighten me. Several people simply rehashed Amiga technical specs, but others raised some excellent points, especially regarding my admitted preference for IBM and compatible PC's. Ironically enough, in all the hubbub, we've still received no new articles on the Amiga, although a few are in the works.

Before I discuss the reader responses, let me explain why I have the attitude I do. Then when you disagree at least you'll understand where I'm coming from.

How I became a PC-philiac

In the fall of 1979 I bought a computer called the SYM. It had a 6502 CPU and 1K of static RAM, expandable to 4K on-board. The SYM was 99% compatible with a previous 6502-based computer, the KIM, but better in that it had more on-board memory and I/O, better expandability, a faster tape interface, and the ability to display ASCII text on an oscilloscope. (Video terminals were so expensive in those days that people would use *any* CRT!)

The SYM had a machine language monitor, but no assembler or BASIC. The company promised a ROM-based assembler and BASIC "real soon now (RSN)," but suffice it to say that it took a long time to get those items, during which time I learned much about the joys of programming in machine language by hand.

A user's group sprung up; by then I had written a machine-language debugger (which I sold through the user's group), a primitive RS-232 communication program (for transferring files with a friend who used a

SWTPC 6800), and had "modified" (disassembled and patched) a commercial text editor to work the way I wanted. (At work I used CP/M machines, still too expensive for "personal" use.) I also built my own EPROM burner and continually fiddled with enhancing my software, burning it into 2716's, and installing them on the board.

Eventually I bought a card cage and a memory board, and expanded to the limit of 32K. I almost bought disk drives at several points, but just couldn't justify spending \$2000 for a pair of 80K drives (albeit with power supply).

I learned a lot from those experiences. I used to know most 6502 opcodes in hexadecimal, and could view an uncommented assembly listing and get a pretty good idea of what was going on. I knew every address used for I/O in the machine. I knew every product on the market, as well as the expected release dates of all of those that were still in the RSN category.

Eventually I got married and went to graduate school; at that point I couldn't afford to maintain the SYM as a full-time avocation. I needed

something that worked, that I could count on, and that was supported in such a way that I knew I would be able to get the tools I needed. If you wanted to pin down a precise moment when I adopted my current attitude, that was it.

I looked long and hard at Apple II's and Commodore PET's, for which lots of interesting software was available, but found that their video displays were poor, and expansion prices too high.

Then Morrow Designs introduced a cheap (under \$2000) 4-MHz Z80 system that included two 160K floppy drives, 64K of RAM, a 19,200 baud video terminal, and came bundled with some basic software, including WordStar and MBASIC. Of course, CP/M had its own assembler and debugger. The Morrow system got me through graduate school, and also helped me launch my career as a writer and journalist.

I was working for a company in lower Manhattan that suddenly moved out to the middle of Long Island. Rather than change jobs, I bought a Radio Shack Model 100, and tapped out numerous stories while commuting on the Long Island

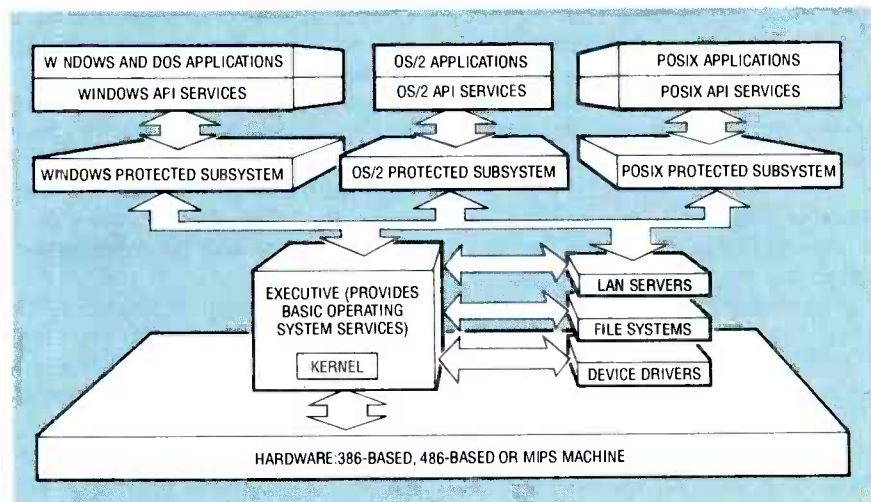

FIG. 1—MICROSOFT'S UPCOMING OS/2 3.0 provides an operating system kernel that can run Windows, OS/2, and POSIX applications in their native modes on Intel and MIPS processors.

Railroad. In fact, one of the first stories I ever sold (to the now-defunct *80 Micro*) was a hardware/software interface to allow the M100 to be used as a modem for a desktop machine—the *Morrow*.

I used the *Morrow* until early 1986, when I decided that I just couldn't afford to let the PC world go by any longer. So I bought an XT, some IBM Technical Reference Manuals, and started learning everything I could about the machine. It was all down hill from there.

I have no religious attachment to the IBM/compatible world. However, I do have a substantial investment in time and brain cells in it. I try to keep an eye on other markets, but it's impossible even to keep up with all facets of the PC market.

Perhaps that type of personal history has no place in a column like this. But I felt it important to show that I didn't just jump on the PC bandwagon arbitrarily. I've paid some dues, and I've always made my technology decisions with care.

On the other hand, as several readers pointed out, I as an editor of **Radio-Electronics** have a responsibility to my readers. And I take that responsibility seriously. Over the years we've published stories on virtually all major personal computers, including Amiga's, Atari's, Macintoshes, Apple II's, etc. And don't forget the 13-part series on the PT-68K we ran in 1986-87.

Nonetheless, surveys repeatedly confirm that 80% or more of our readers own and use PC compatibles. And I suspect that 80% or more of our authors do as well. Unlike most other magazines, **Radio-Electronics** relies heavily on its readership for editorial input. The lack of Amiga stories is traceable to that fact.

Reader replies

Anyway, here's what some readers had to say about the April column.

Jim Belcher of Greenville, TX brought up an extremely important point: Standardization can stifle innovation. I agree—but there must be a balance, and it must be a dynamic, ever-shifting balance. Too much standardization leads to innovation, which in turn leads to efforts at standardization, and so on. My interest in standardization relates to interoperability, data exchange, and volume produc-

tion. I'd like to be able to transparently connect numerous heterogeneous computer systems to a network, and to share data among them. I'd like to be able to trade floppy disks with Mac and Amiga users. I'd like to be able to plug-n-play SCSI devices among them as well. I'd like video standards that would allow volume manufacturing techniques to produce high-resolution video displays as cheaply as TV sets. And so on. Innovation is absolutely necessary—but it must be carried out within the context of solving real problems.

Paul Schick of Madison, WI wrote a really thoughtful letter touching on standards and standardization, and points out that the issue is not "doomed PC's versus doomed Macs versus doomed Amigas. The issue is our own data, which we must somehow get out of that DOS window and onto that machine of the future, to say nothing of moving it from one application to another." Mr. Schick then goes on to lament how we have allowed manufacturers to bamboozle us into accepting proprietary data formats as a method of market control. Hear, hear!

Tom Hutchison of Pilot Rock, OR suspects that the whole thing was an April Fools joke. Sorry.

Neil Gjere of St. Paul, MN suggested that we do a price/performance comparison of various architectures (Mac, Amiga, PC). When Apple first introduced the Mac II line, we approached the company for a review machine to do just that. The company unceremoniously declined. Attempts around the same time to contact Commodore went totally unanswered. IBM on the other hand has always been extremely cooperative, as have hundreds of other PC hardware and software vendors. We don't have the resources of *Byte*, *PC Magazine*, or *Amiga World*. But we don't try to compete with those magazines either.

Patrick Greene wrote from Fort Ord, CA and objected to my statement that Windows has done more to promote graphical environments than all the Amigas and Macs put together, and goes on to point out how the Amiga provides a better multi-tasking operating system. I did not say that Windows is better, but that it has been more successful in *marketing* the GUI. It wasn't long ago

when the vast majority of PC users considered mice wimpy. The cultural shift brought on by the acceptance of Windows is amazing.

Brian Redman of Richmond, BC (Canada) states that the success of the PC was due to two things, "its birth under the IBM logo, and the company's now recanted policy of open architecture." Good points. But then he goes on to say that, "The fact that IBM and Apple are just now waking up to the usefulness of multi-tasking, multimedia, etc., is a testament to the vision of the original Amiga development team, Xerox Star notwithstanding." Now there's an original way of distorting history. Multi-tasking predates both Commodore and the Xerox effort in the mainframe operating systems that were being used in the 60's.

Frank Podroskey, Jr. of Monongahela, PA berates my snobbish attitude toward Amigas, saying that it "is what most Amiga owners resent more than anything else from owners of other machines." To that I plead guilty, and promise to try to be more open minded.

Your turn

So what are we going to do, readers? I say we because admittedly I can't do it all myself. You want more Amiga coverage? OK. Do it. The ball's in your court. It's time to stop saying "somebody oughta do something" and start doing it. Don't rewrite the technical specs, but do something creative—that's what all that multi-tasking and multi-media are about. Then tell us. We'll get the word out. Regarding news coverage, we'll try to keep a closer eye on the Amiga market. But if you see something you think should be publicized, let us know about it. Give us a company name, product/technology description, and a phone number. We'll take it from there.

News bits

486SX Released. Intel finally unveiled the 486SX, a 20-MHz coprocessor-less 486. Adding a coprocessor involves adding a new IC, which in effect is a full 486 that completely takes over for the 486SX. That's required because the CPU and the FPU must reside in the same package, else propagation delays negate any performance advantage. However, together the two cost

about 30% more than a real 486. Initial benchmarks indicate that the 20-MHz 486SX runs roughly equivalent to AMD's 40-MHz 386. IBM, Acer, ALR, AST, Everex, and others immediately announced systems based on the 486SX, some priced well under \$3000. IBM also showed a prototype 50-MHz 486 system, but there is no word from Intel on when production quantities will be available. One report mentioned a 486 that runs internally at 50 MHz but has a 25-MHz bus interface; the chip could be a drop-in replacement requiring no system redesign or FCC certification. Clearly, with competition heating up in the 386 market, Intel is trying to establish a range of 486's at popular price points. Meanwhile **AMD** has announced a 25-MHz 386SX but we don't know how much it will cost.

Notebook Nirvana. HP and Lotus introduced a 10-oz hand-held 512K 8088-based PC compatible with 1-2-3 version 2.2 and several small application programs built in. It's amazing how much they packed in, but the display is only 40 charac-

ters by 16 lines, and the keys are too close together for touch typing. **Fujitsu** has released (in Japan only) a two-pound notebook that is an inch thick, has a full keyboard, runs for 8 hours on two AA batteries, and has no rotating parts (i.e., disk drives). It's based on Intel's 386SL and uses IC cards for volatile and non-volatile storage. And **Kyocera** has released (also in Japan only) a pen-input DOS-based system built into a thin binder. The inside cover contains a 240 x 340 pixel screen used for both input and output. A separate tablet clips into the binder, communicates with the screen via inductance, and provides some sort of keyboard. There's talk of marketing the device in Europe, and possibly also here in the U.S., although no firm date has yet been determined.

IBM and Microsoft continue to diverge on **Windows and OS/2**. IBM has teamed up with Micrografx, a premier developer of Windows-based drawing tools, device drivers, and Windows-to-OS/2 porting technology, to co-develop a 32-bit graphics engine to replace the current 16-

bit engine for the OS/2 Presentation Manager. There's also talk that, like Windows, OS/2 2.0 will include a suite of basic desktop applications. In addition, IBM has shown OS/2 2.0 running DOS and Windows apps simultaneously and faster than in their native modes.

On the Windows front, Microsoft talks more and more about OS/2 version 3.0, AKA "New Technology," a portable version that will have the ability to run Windows, OS/2, and POSIX applications simultaneously over the same operating system kernel.

Microsoft is still struggling with TrueType, its PostScript killer, and in the meantime, Adobe's ATM is getting lots of good exposure. In addition, Adobe is about to introduce an enhanced version of its font technology that will allow a continuous range of letter weights from very light to very bold. The **FTC** is investigating charges that Microsoft hasn't been on the up and up regarding separating its systems and application divisions. Look for the company to split by year end. **R-E**

AUDIO UPDATE

continued from page 80

on blank DAT tapes to compensate them for the assumed losses resulting from unauthorized dubbing of their copyrighted material. Their argument is that since DAT copies of CD recordings are virtually perfect, consumers will be encouraged to engage in orgies of unauthorized dubbing. The fact that you can already make a virtually perfect copy of a CD with any high-quality cassette deck seems to have escaped the MPA's attention. And the additional fact that all DAT decks come with circuits that prevent multiple copies of the same CD seems to have deterred the litigating music merchants hardly at all in their pursuit of enhanced royalties.

In my May 1988 column, I predicted that the DAT format—for all the reasons discussed above—wouldn't make it as a mass-market product. (I was probably the *only* U.S. audio writer who wasn't all moist- and starry-eyed about DAT's prospects during those early days.) The present word

in the hi-fi industry is that DAT sales are poor and that as a consumer product it is dead or dying. Any childish pleasure that I may derive from "I told you so's" is offset by consideration of the enormous amounts of time, effort, and cash invested in developing the DAT technology. I hope it won't be a total waste, and that there will be some worthwhile spin-offs in the future.

DCC?

Are you waiting with bated breath for my pronouncements on the Digital Compact Cassette? Or have you even heard of it? Philips promises that by mid-1992, new format machines will be available that will play *both* standard cassettes *and* similar size digital cassettes employing a new "precision adaptive sub-band encoding" data-compression system. PASC encoding, perhaps needless to say, is incompatible with any current coding system.

Philips promises that the DCC tapes will sound as good as CD's and will have the advantage (over conventional cassettes) of CD-type program selection. Projected playing time is

90 minutes, but that will probably be extended. Tandy has already demonstrated prototypes, and there's a rumor that the giant Matsushita Corporation (Panasonic, Technics, JVC) is ready to commit to the format. Price of the machine is projected at between \$500 and \$600—about the same price as a high-quality cassette deck.

Will DCC be a hit or a miss? Short of unlikely fidelity problems in the PASC encoding, and endless litigation by the music merchants, I don't see how the format can fail commercially. It incorporates the known and well-accepted virtues of conventional cassettes and promises CD-level performance and convenience for its digital cassettes. There are design errors waiting to be made in the new machines—such as providing less than state-of-the-art performance from the conventional part of the machine—but if these are avoided, then DCC will be the wave of the future. I'm sure that Sony will go down fighting for DAT—as they did for Beta—but I'm afraid it's a lost cause. As I've said before in this column: In a year or two, we'll know if I'm right. **R-E**

MARKET CENTER

FOR SALE

TUBES: "oldest," "latest." Parts and schematics. SASE for lists. **STEINMETZ**, 7519 Maplewood Ave., RE, Hammond, IN 46324.

ENGINEERING software, PC/MSDOS. Circuit design and drawing, PCB layout, Logic simulation, FFT analysis, Mathematics, Circuit analysis. Call or write for free catalog. 1 (800) 728-3805, **BSOFT SOFTWARE, INC.**, 444 Colton Rd., Columbus, OH 43207.

RESTRICTED technical information: Electronic surveillance, schematics, locksmithing, covert sciences, hacking, etc. **Huge selection. Free brochures.** **MENTOR-Z**, Drawer 1549, Asbury Park, NJ 07712.

CABLE TV converters: Jerrold, Oak, Scientific Atlantic, Zenith & many others. "New MTS" stereo add-on: mute & volume. Ideal for 400 and 450 owners! 1 (800) 826-7623, Amex, Visa, M/C accepted. **B & B INC.**, 4030 Beau-D-Rue Drive, Eagan, MN 55122.

TUBES, new, up to 90% off, SASE, **KIRBY**, 298 West Carmel Drive, Carmel, IN 46032.

CABLE descramblers (Jerrold) from \$40.00. Tocom VIP test chip. Fully activates unit. Also Zenith test board. Fully activates Z-Tacs. \$50.00. Call (213) 867-0081.

PREVENT descrambler detection! Order Tech-Block today! Simple in-line connection. Only \$19.95 P.P.D. **THE STAGE DOOR VIDEO**, PO Box 518, Belleview, FL 32620. For C.O.D.'s 1 (800) 395-4557.

CHIPS burned. EPROMS, EEPROMS, PALS, GALS, bi-polar PROMS, 8748 & 8751 series devices. Dial our BBS at (606) 253-4962 for details.

SHAREWARE, 1000's of programs available. Catalog \$3.00. **STELLAR SOFTWARE PRODUCTS**, PO Box 6202, San Mateo, CA 94403.

CLASSIFIED AD ORDER FORM

To run your own classified ad, put one word on each of the lines below and send this form along with your check to:

Radio-Electronics Classified Ads, 500-B Bi-County Boulevard, Farmingdale, NY 11735

PLEASE INDICATE in which category of classified advertising you wish your ad to appear. For special headings, there is a surcharge of **\$25.00**.

Plans/Kits Business Opportunities For Sale
 Education/Instruction Wanted Satellite Television

Special Category: \$25.00

PLEASE PRINT EACH WORD SEPARATELY, IN BLOCK LETTERS.

(No refunds or credits for typesetting errors can be made unless you clearly print or type your copy.) Rates indicated are for standard style classified ads only. See below for additional charges for special ads. **Minimum: 15 words.**

| | | | | |
|--------------|--------------|---------------|---------------|---------------|
| 1 | 2 | 3 | 4 | 5 |
| 6 | 7 | 8 | 9 | 10 |
| 11 | 12 | 13 | 14 | 15 (\$46.50) |
| 16 (\$49.60) | 17 (\$52.70) | 18 (\$55.80) | 19 (\$58.90) | 20 (\$62.00) |
| 21 (\$65.10) | 22 (\$68.20) | 23 (\$71.30) | 24 (\$74.40) | 25 (\$77.50) |
| 26 (\$80.60) | 27 (\$83.70) | 28 (\$86.80) | 29 (\$89.90) | 30 (\$93.00) |
| 31 (\$96.10) | 32 (\$99.20) | 33 (\$102.30) | 34 (\$105.40) | 35 (\$108.50) |

We accept MasterCard and Visa for payment of orders. If you wish to use your credit card to pay for your ad fill in the following additional information (Sorry, no telephone orders can be accepted.):

Card Number

Expiration Date

Please Print Name

Signature

IF YOU USE A BOX NUMBER YOU MUST INCLUDE YOUR PERMANENT ADDRESS AND PHONE NUMBER FOR OUR FILES. ADS SUBMITTED WITHOUT THIS INFORMATION WILL NOT BE ACCEPTED.

CLASSIFIED COMMERCIAL RATE: (for firms or individuals offering commercial products or services) \$3.10 per word prepaid (no charge for zip code)...**MINIMUM 15 WORDS.** 5% discount for same ad in 6 issues; 10% discount for same ad in 12 issues within one year; if prepaid. **NON-COMMERCIAL RATE:** (for individuals who want to buy or sell a personal item) \$2.50 per word, prepaid...no minimum. **ONLY FIRST WORD AND NAME** set in bold caps at no extra charge. Additional bold face (not available as all caps) **55¢ per word additional.** Entire ad in boldface, \$3.70 per word. **TINT SCREEN BEHIND ENTIRE AD: \$3.85 per word. TINT SCREEN BEHIND ENTIRE AD PLUS ALL BOLD FACE AD: \$4.50 per word. EXPANDED TYPE AD: \$4.70 per word prepaid.** Entire ad in boldface, \$5.60 per word. **TINT SCREEN BEHIND ENTIRE EXPANDED TYPE AD: \$5.90 per word. TINT SCREEN BEHIND ENTIRE EXPANDED TYPE AD PLUS ALL BOLD FACE AD: \$6.80 per word. DISPLAY ADS:** 1" x 2 1/4"—\$410.00; 2" x 2 1/4"—\$820.00; 3" x 2 1/4"—\$1230.00. **General Information:** Frequency rates and prepayment discounts are available. **ALL COPY SUBJECT TO PUBLISHERS APPROVAL. ADVERTISEMENTS USING P.O. BOX ADDRESS WILL NOT BE ACCEPTED UNTIL ADVERTISER SUPPLIES PUBLISHER WITH PERMANENT ADDRESS AND PHONE NUMBER.** Copy to be in our hands on the 5th of the third month preceding the date of the issue. (i.e., Aug. issue copy must be received by May 5th). When normal closing date falls on Saturday, Sunday or Holiday, issue closes on preceding working day. Send for the classified brochure. Circle Number 49 on the Free Information Card.

CALL DOCTOR DESCRAMBLER

...for symptoms relating to scrambled cable T.V. signals. We have • **JERROLD**
 • **TOCOM** • **ZENITH**
 • **HAMLIN** • **OAK**
 • **SCIENTIFIC ATLANTA.**

Six month warranty! We ship C.O.D. Lowest retail/wholesale prices. **FREE CATALOG:** VISA, M.C., AM.EX.

Global Cable Network
 1032 Irving St. Suite
 109 S.F., CA 94122
NO CALIFORNIA SALES!!!
OPEN SATURDAYS



1-800-327-8544

FREE CATALOG

FAMOUS "FIRESTIK" BRAND CB ANTENNAS AND ACCESSORIES. QUALITY PRODUCTS FOR THE SERIOUS CB'er. SINCE 1962
FIRESTIK ANTENNA COMPANY
 2614 EAST ADAMS
 PHOENIX, ARIZONA 85034

LASER beam in, animation out of spinning hologram! From stellar to sexy. Brochure. HOLOVISION, (206) 682-7559.

CABLE TV converters and descramblers. We sell only the best. Low prices. SB-3 \$79.00. We ship C.O.D. Free catalog. ACE PRODUCTS, PO Box 582, Dept. E, Saco, ME 04072. 1 (800) 234-0726.

T.V. notch filters, phone recording equipment, brochure \$1.00. MICRO Thinc., Box 63/6025, Margate, FL 33063. (305) 752-9202.

PHOTOFACT folders under #1400 \$5.00. Others \$7.00. Postpaid. LOEB, 414 Chestnut Lane, East Meadow, NY 11554. (516) 481-4380.

CABLE CONVERTERS all major brands info + orders 1 (800) 782-0552 FREEWAY INC. (s.m.p.), PO 5036, Burnsville, MN 55337.

CIRCUIT Center — Complete circuit fabrication from single piece single sided to production multi-layer. Also — Laminate \$5.50/sq. ft., etch \$3.50/qt. Thru hole plating available too. **CIRCUIT CENTER**, Dept. 001, PO Box 128, Addison, IL 60101. (708) 543-0671.

WIRELESS CABLE RECEIVERS 1.9 TO 2.7 GHz



30 CH PARABOLIC DISH SYSTEM \$173.99
 30 CH ROD ANTENNA SYSTEM \$193.99
 30 CH CRYSTAL CONTROLLED SYSTEM \$294.95
SUN MICROWAVE INT'L. INC. SEND \$1.00 FOR P.O. BOX #34522 CATALOG ON THESE PHOENIX, AZ 85067 AND OTHER FINE VIDEO PRODUCTS QUANTITY DISCOUNTS
 ORDERS ONLY 1-800-484-4190 CODE 9793

SUPER low prices on computers, motherboards, hard and floppy drives, add-on cards. We have everything. Full line of test equipment at unbeatable prices. Call for free catalog. **APPLIED ELECTRONIC RESEARCH, INC.**, 4701 SW 45th Street, Ft. Lauderdale, FL 33314. (305) 987-9785.

FREE catalog. Interfaces for IBM compatibles. Digital I/O 48 TTL lines (2ea. 8255s) \$69.95, 16 ch. analog input 0 to 5v 8 bit. \$89.95. **JOHN BELL**, 1381 Saratoga St., Minden, NV 89423. (702) 267-2704.

CB RADIO OWNERS!

We specialize in a wide variety of technical information, parts and services for CB radios. 10-Meter and FM conversion kits, repair books, plans, high-performance accessories. Thousands of satisfied customers since 1976! Catalog \$2.

CBC INTERNATIONAL
 P.O. BOX 31500RE, PHOENIX, AZ 85046

HOTTEST cable bargain, all descramblers come with a factory refurbished 61 channel remote converter at the price you would pay for a descrambler only. SA-3-B with converter \$89.00, fast Tri-Bi with converter \$89.00, MLD-1200 Hamlin with converter \$79.00. S.A.C., 1 (800) 622-3799.

PC scope. 24 Mhz digital scope board for the IBM PC & compatibles. 2k ram, PRE & POST trigger, .5V to 50V range, software with FFT. Uses PC short slot. \$175.00. Call or write for free demo disk. **SOFTTECH**, 51 Willow Ct., Hamilton, NJ 08619. (609) 588-0679.

INTERFERENCE filters, all channels. Best quality, cylinder type. Best prices. Visa, MC, COD accepted. Large quantities available. We now have ch# 10 and 11 in stock. 1 (800) 872-5912.

EXOTIC miniature electronic devices, catalog \$5.00, refundable. **F&P ENTERPRISES**, Box 51272, Palo Alto, CA 94303-L.

CABLE TV converters & descramblers for Jerrold and Scientific Atlanta. Low prices, one year warranty. We ship COD. **BAY STATE ELECTRONICS**, PO Box 103, Boston, MA 02188. 1 (800) 359-9806.

CABLE bargains, RTC-56 \$99.00, Tocom 5503A \$199.00, M-35-B Oak \$35.00, Hamlin CRX-6600-3M \$125, Hamlin MLD-1200 \$49.00, X-12 Oak \$49.00, 4040-DIC \$89.00, all others in stock. S.A.C., 1 (800) 622-3799.

CABLE descramblers, new X-12 Oak descrambler \$49.00 — 1, \$39.00 — 10, \$29.00 — 20, Hamlin CRX-6600 with remote \$129.00 — 1, \$110.00 — 10, \$99.00 — 20, Oak M-35-B \$40.00 — 1, \$35.00 — 10, \$30.00 — 20, 5503A Tocom with remote \$199.00, Sylvania-Texcan 4040-DIC with remote, replaces Jerrold 400-DIC \$99.00 — 1, \$89.00 — 10, \$69.00 — 20, Oak RTC-56 with remote \$125.00 — 1, \$115.00 — 10, \$99.00 — 20, SA — Tri-Bi — Zenith — same low prices. **MOUNT HOOD ELECTRONICS**, (503) 253-0459.



Quality Microwave TV Antennas

WIRELESS CABLE - IFTS - MMDS - Amateur TV Ultra High Gain 50db(+) • Tuneable 1.9 to 2.7 GHz.
 • 36-Channel System Complete \$149.95
 • 12-Channel System Complete \$114.95
 • Call or write (SASE) for "FREE" Catalog

PHILLIPS-TECH ELECTRONICS
 P.O. Box 8533 - Scottsdale, AZ 85252
 (602) 947-7700 (\$3.00 Credit all phone orders)
 MasterCard • Visa • COD's • Quantity Pricing

VCR secrets. Booklet shows how to record 8 hours continuous audio on VCR. Nothing to build. Send \$10.00 to: **BROOKSIDE INNOVATIONS**, Box 62, Martinsville, NJ 08836.

COMPLETE IBM computer system, new, 640K memory with keyboard, monitor, two drives, \$495.00. Includes one year warranty. Send \$5.00 for information to **THE DATA FACTORY**, 7433 Kaiser, Fontana, CA 92336.

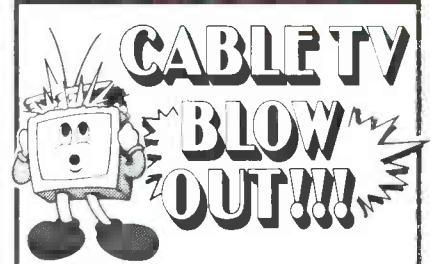

CHOOSE FROM THE FOLLOWING PACKAGES:

PKG. #1...
 10 PANASONIC 1453G CONVERTERS \$65^{EA.}

PKG. #2...
 8 SCIENTIFIC ATLANTA 8536+ COMBINATIONS \$175^{EA.}

PKG. #3...
 5 SCIENTIFIC ATLANTA 8580 COMBINATIONS \$215^{EA.}

PKG. #4...
 10 MIX AND MATCH ADD-ONS \$45^{EA.}

ALL EQUIPMENT IS BRAND NEW, FACTORY FRESH !!!
 CALL (800) 234-1006 **CABLE READY** Company
 for additional information and a catalog

PERFECT CABLE CONNECTION !!

THIS SPACE CONTRIBUTED AS A PUBLIC SERVICE

Perfect Cable Connection is totally committed to customer satisfaction. Our primary concern is to provide you with the highest quality converters and descramblers at the lowest cost. We employ full time technicians to insure hassle free service and troubleshoot any situation. Call us today and let us prove to you why we are the Perfect Cable Connection.

- 6 months 100% parts & labor
- 24 months warranty available
- Full technical support
- On-line computer system
- 30 days money back guarantee
- Most orders shipped within 24 hours
- Visa, M/C, AMEX - 5%
- Dealers welcome
- C.O.D.

A defense against cancer can be cooked up in your kitchen.

There is evidence that diet and cancer are related. Follow these modifications in your daily diet to reduce chances of getting cancer:

1. Eat more high-fiber foods such as fruits and vegetables and whole-grain cereals.
2. Include dark green and deep yellow fruits and vegetables rich in vitamins A and C.
3. Include cabbage, broccoli, brussels sprouts, kohlrabi and cauliflower.
4. Be moderate in consumption of salt-cured, smoked, and nitrite-cured foods.
5. Cut down on total fat intake from animal sources and fats and oils.
6. Avoid obesity.
7. Be moderate in consumption of alcoholic beverages.

No one faces cancer alone.

AMERICAN CANCER SOCIETY

| | | | | |
|---|---|--|---|--|
| Jerrold 400 DRX 3 DIC WR 1 119 5 89 10 79 20 69 50 65 100 CALL | SA 8536 WR 1 225 5 205 10 185 20 170 50 CALL 100 CALL | Regal RC 83 WR 1 89 10 69 20 65 50 60 100 55 | 'New' -99 Ch capacity - Wireless remote - Automatic fine tuning - Parental lock - Made in Japan - Super small - Favorite memory channels | Orion M3-B 3 or 2 1 39 5 35 10 30 20 27 50 CALL 100 CALL |
| Filters 1 CALL 10 CALL 5 CALL 20 CALL 50 CALL 100 CALL | Jerrold 450 DRZ 3 DIC WR 1 129 5 99 10 89 20 79 50 CALL 100 CALL | SA 8500-311 WR 1 199 5 175 10 150 20 CALL 50 CALL 100 CALL | Zenith ZTACS All models Call for prices | CRX 5000 3M WR 1 119 5 99 10 79 20 69 50 CALL 100 CALL |
| Jerrold 400 DRX 3105 WR 1 55 5 49 10 45 50 40 | TB 3 1 75 10 48 20 43 50 39 100 35 | SA-3B 1 75 10 48 20 43 50 39 100 35 | Jerrold 450 DRZ 3 WR 1 68 10 55 20 45 50 40 | FTB-3 1 99 10 79 20 65 50 CALL 100 CALL |

WE WILL MEET OR BEAT ANY ADVERTISED PRICE IN THIS MAGAZINE.

PERFECT CABLE CONNECTION

702-358-2763
 2209 Oddie Blvd., Suite 321
 Spark, NV 89431

Cable Descramblers

New Auto Tri-Bi guaranteed no flashing \$165.00

| | | | |
|-----------------|----------|--------------------|----------|
| SB-3..... | \$99.00 | ZENITH SUPER | |
| TRIMODE..... | \$109.00 | SAAVI..... | \$199.00 |
| HAMLIN..... | \$99.00 | TOCOM..... | \$319.00 |
| SCIENTIFIC..... | | EAGLE..... | \$119.00 |
| ATLANTA..... | \$119.00 | COPY GUARD..... | \$59.95 |
| OAK M35B..... | \$99.00 | STARGATE 2000..... | \$88.00 |
| ZENITH..... | \$175.00 | | |

M.D. Electronics will match or beat any advertised wholesale or retail price.

Your best buys and warranties for cable converters and descramblers start with a FREE catalog from MD

For Information Call

402-554-0417

To order or request a free catalog

1-800-624-1150



M.D. ELECTRONICS

875 SO. 72nd St.
Omaha, NE 68114

BY ORDERING CABLE TV EQUIPMENT FROM M.D. ELECTRONICS THE PURCHASER AGREES TO COMPLY WITH ALL STATE AND FEDERAL LAWS REGARDING PRIVATE OWNERSHIP OF CABLE TV EQUIPMENT. IF YOU ARE UNSURE OF THESE LAWS CHECK WITH YOUR LOCAL OFFICIALS.

CIRCLE 53 ON FREE INFORMATION CARD

EXCELLERATOR™ Series

CABLE CONVERTERS

WHEN QUALITY COUNTS



New Dynatrack™ fine tuning provides unmatched picture quality
550 Mhz tuner provides 83 channel capacity
Sleep timer for automatic shut off within 15-90 minutes
2/3 switchable HRC / IRC / Standard Switchable
2 Year warranty, Last channel recall, Favorite channel select, Scan
Double vented high efficiency transformer for cool performance
Stargate-2001 \$99.00

Stargate-550XL \$119.00 With Volume Control

Don't settle for anything less.



C.O.D.

CABLE T.V. DESCRAMBLERS

BASE BAND



Starcom 7

\$399.00

| | | | |
|------------------|----------|--------------|----------|
| DQN7V..... | \$120.00 | SA8580..... | \$299.00 |
| TRIMODE..... | \$95.00 | SB3..... | \$74.95 |
| ZENITH 1612..... | \$329.95 | PIONEER..... | \$399.00 |
| DQN7..... | \$99.00 | | |

MANY MORE...CALL OR WRITE FOR FREE FAST INFORMATION.

YOUR BEST BUY'S & WARRANTIES FOR CABLE CONVERTERS AND DESCRAMBLERS START WITH A FREE CATALOG FROM:

WORLDWIDE CABLE

7491 C-5 N. Federal Hwy.
Suite #142
Boca Raton, FL 33487

ORDERS AND CATALOGS CALL TOLL FREE

1-800-772-3233



C.O.D.



BY ORDERING CABLE TV EQUIPMENT FROM WORLDWIDE CABLE THE PURCHASER AGREES TO COMPLY WITH ALL STATE AND FEDERAL LAWS REGARDING PRIVATE OWNERSHIP OF CABLE TV EQUIPMENT. IF YOU ARE UNSURE OF THESE LAWS CHECK WITH YOUR LOCAL OFFICIALS.

PLANS AND KITS

DAZER personal protectors! Lasers! AM/FM/Infrared transmitters! Detectors! More! Kits/assembled. Catalog \$2.00. **QUANTUM RESEARCH**, 16645-113 Avenue, Edmonton, Alberta T5M 2X2.

SURVEILLANCE — Audio/video/infrared/laser equipment. Industrial or private. 500 item catalog \$7.00. **SECURITY SYSTEMS**, 3017G Hudson Pl., New Orleans, LA 70131.

DESCRAMBLING, new secret manual. Build your own descramblers for cable and subscription TV. Instructions, schematics for SSAVI, gated sync, sinewave, (HBO, Cinemax, Showtime, UHF, adult) \$12.95, \$2.00 postage. **CABLETRONICS**, Box 30502R, Bethesda, MD 20824.

LASERS



New Laser Diodes \$15

Helium-Neon Laser Tubes from \$25

COMPLETE HELIUM-NEON LASERS FROM \$59.00

FREE CATALOG Call or Write Today!

MEREDITH INSTRUMENTS PO. Box 1724/Glendale, AZ 85311/(602) 934-9387

SMD How to use surface mount technology. Build ultra miniature projects. Plans included free, infra red control, and an interesting light display. Send \$15.00 to **CHARLIE'S VIDEO**, Dept. SRT, PO Box 7782, La Sierra, CA 92503.

HOBBY/broadcasting/HAM/CB/surveillance transmitters, amplifiers, cable TV, science, bugs, other great projects! Catalog \$1.00. **PANAXIS**, Box 130-F8, Paradise, CA 95967.

BUILD from simple materials, phenomenal economy carburetor. Detailed plans for five versions. Good science project. Send \$20.00 cheque, money order or Visa to: **VALLEY MICROWAVE**, Station C, Bear River, Nova Scotia, Canada BOS 1B0 or phone (902) 467-3577.

REMOTE CONTROL KEYCHAIN

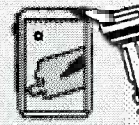

Complete w/mini-transmitter and +5 vdc RF receiver Fully assembled including plans to build your own auto alarm Quantity discounts available

\$24.95 Check, Visa or M/C Add \$3 shipping

VISITECT INC. BOX 5442, SO. SAN FRAN., CA. 94080
(415) 531-8425 Fax (415) 531-8442

HYPNOTIZE or Relax electronically! Alpha/meditation goggles. Complete kit \$53.00. Free information. **MARK WORLEY**, Box 261113, San Diego, CA 92196.

SURVEILLANCE transmitter kits! Four models of each; telephone, room, combination telephone/room transmitters tune from 65 to 305 MHz. Catalog with **Popular Communications** and **Popular Electronics** book reviews of "Electronic Eavesdropping Equipment Design," \$2.00. **SHEFFIELD ELECTRONICS**, 7223 Stony Island Ave., Chicago, IL 60649-2806.

FREE cable and satellite descrambler plans. Send self addressed stamped envelope. **MJM INDUSTRY**, Box 531, Bronx, NY 10461-0208.



ANNOUNCING:

AN END TO HIGH MONTHLY CABLE FEES!

All Jerrold, Oak, Hamlin, Zenith, Scientific Atlanta, Magnavox and all specialized cable equipment available for shipment within 24 hours. For fast service MC/VISA or C.O.D. telephone orders accepted. 60 Day Guarantee (Quantity Discounts). Send self-addressed Stamped envelope.

1-800-232-5017



C.O.D. ORDERS ACCEPTED



CABLE-TRONICS, INC.

1304 E. Algonquin Road Suite 501
Algonquin, Illinois 60102

TBC frame synchronizer kits for 1/2 and 3/4 inch VCRs \$595.00 to \$1,895.00 **ROGUE RESEARCH**, (503) 582-4324, PO 729, Rogue River, OR 97537.

INVESTIGATORS, experimenters — Quality new plans. Micro and restricted devices. Free catalog. Self addressed stamped envelope required. **KELLEY SECURITY, INC.** Suite 90, 2531 Sawtelle Blvd., Los Angeles, CA 90064.

TELEPHONE caller identifiers. Displays incoming caller's telephone number, kit \$49.95 postpaid, **SURVEILLANCE** catalog \$5.00, **EDE**, POB 337, Buffalo, NY 14226.

DESCRAMBLER kits. Complete cable kit \$44.95. Complete satellite kit \$49.95. Add \$5.00 shipping. Free brochure. **SUMMIT RE**, Box 489, Bronx, NY 10465. No NY sales.

MAXIMUM security for mini-price. Our versatile micro-controller lets you design the vehicle security system you want. Choose your options from those available in high-end systems, including: passive or active operation, zone status reporting, surveillance monitoring (informs of intrusions), chirp and sensor bypass, five monitored loops, three control outputs, panic alarm, valet mode, A/V display, full remote capabilities, etc. Kit includes micro-controller, schematic and instructions. To order, send \$34.95 + \$3.50 S/H to: **KHEPRI TECHNOLOGIES**, PO Box 460186, Aurora, CO 80046. Delivery in 2-4 weeks. Or call (303) 680-9989 for detailed informational brochure.

ANTIQUE RADIO CLASSIFIED

Free Sample!

Antique Radio's
Largest Circulation Monthly.
Articles, Ads & Classifieds.

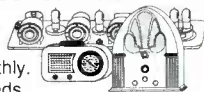

6-Month Trial: \$15. 1-Yr: \$27 (\$40-1st Class).
A.R.C., P.O. Box 802-L9, Carlisle, MA 01741

BUILD subwoofers for home theater. Save. Complete instructions \$6.95. **WILLIAM CROWLEY**, 2118 Wilson, Hollywood, FL 33020.

PCB and schematic CAD \$195.00 IBM EGA CGA Multilayer, rubberband, autovia, NC drill, laser, dot matrix, plotter, library, Gerber, **AUTOSCENE**, 10565 Bluebird St., Minneapolis, MN 55433. (612) 757-8584 free demo disk.

WIRE sorter, save time and money when identifying multiple wire runs and bundles. Easy to follow prints and instructions. Send \$5.00 to **PATTEN ENTERPRISES**, PO Box 1666, Spring Valley, CA 91978-1666. CA residents add 35 cents.

CABLE DESCRAMBLERS OAK M35B COMBO \$39.95

Jerrold, Zenith, Hamlin, Sci. Atlanta, Pioneer & MORE! OUR PRICES ARE BELOW WHOLESALE!

CABLE PLUS

14417 Chase St. #481-A Panorama City, CA 91402
1-800-822-9955 • Other Info. 1-818-785-4500
NO CALIF. SALES — DEALERS WANTED

SATELLITE TV

FREE catalog — Lowest prices worldwide, save 40 — 60%. Systems, upgrades, parts, all major brands factory fresh and warranted. **SKYVISION**, 2009 Collegeway, Fergus Falls, MN 56537. 1 (800) 334-6455.

CABLE TV Secrets — the outlaw publication of the cable companies tried to ban. HBO, Movie Channel, Showtime, descramblers, converters, etc. Suppliers list included. \$9.95 **CABLE FACTS**, Box 711-R, Pataskala, OH 43062.

I'LL HAVE MINE DESCRAMBLED



If you find a better deal, We'll beat it! **JERROLD • TOCOM • HAMLIN • OAK • SCIENTIFIC ATLANTA • ZENITH** • ask about our warranty program C.O.D. Visa, M/C, AM EX. welcome. • **FREE CATALOG** • **FREE CALL** • **OPEN SATURDAYS**

1 800 562-6884

VIDEO TECH
3702 S. Virginia St. Ste. 160-304
Reno, NV 89502

Do it yourself, systems, upgrades, major brands discounted, save 30% — 60%. Lowest prices anywhere. L.J.H. INC., call Larry at (609) 596-0656.

THE ELECTRONIC GOLDMINE

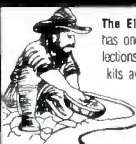

The Electronic Goldmine has one of the greatest selections of unique electronic kits available in the world! We have over 130 kits and over 1,400 unique, bargain priced, components in our catalog!



ITT MOUSE
Precision mouse made for the ITT XTRA personal computer. Shipped complete with cables, box containing circuit board, mouse, software disks and manual.
G516 **\$5.00**

INFRARED DETECTOR KIT

Great for testing and verification of infrared output. Uses sensitive sensor and electronic circuitry to respond to all types of infrared TV, VCR, etc. remote controllers and LEDs producing sound and lighting a bright red LED. 9V battery (not included). Size of board: 2.5" x 1.4". Complete with all parts. PC board and instructions.
C6411 **\$5.95**

ULTRASONIC PEST REPELLER KIT

According to research, low intensity ultrasonic sound waves repel insects and small rodents. The output of this kit is obnoxious to the pest, but is above the hearing range of humans, dogs, cats, and birds. 9V battery (not included). Size of board: 2.5" x 2". Complete with all parts. PC board and instructions.
C6350 **\$9.00**

4KV TRIGGER COIL

Use with any strobe tube that needs a 3 lead 4KV trigger.
N1700 **\$1.25 EA.**
100 for **\$80.00**

INVERTER TRANSFORMER

Small 4 lead transformer for use with 555 IC to convert 12VDC to 250V for strobe/fluorescent tubes with schematic.
N1703 **\$2.00 EA.**
10 for **\$18.00**

STROBE TUBE & SCHEMATIC

Bright xenon flash tube for making strobe light. Includes schematic showing this tube and trigger coil shown at left. Size of tube: 1.5".
G936 **\$1.39**



ULTRAVIOLET SENSOR SUN EXPOSURE METER

Small electronic device detects UV energy from the sun and sounds a signal when you've had enough exposure. Has 2 dials for skin type and sun screen rating (SPF). Uses IC circuitry and special UV sensor. Assembled and ready to use. This new surplus item is now available at a fraction of the original cost. (Requires 9V battery, not included).
G934 **\$8.95**

MINIMUM ORDER: \$10.00 plus \$3.00 shipping and handling. We accept MC, Visa and Money Orders.
SEND ORDERS TO: The Electronic Goldmine
P.O. Box 5408 Scottsdale, AZ 85261
PHONE ORDERS (602) 451-7454 FAX ORDERS (602) 451-9495

CIRCLE 180 ON FREE INFORMATION CARD

MARK V ELECTRONICS, INC.

Competitive Pricing * Fast Shipping

Since 1985

ORDER IN CALIFORNIA 800-521-MARK

ORDER OUTSIDE CA 800-423-FIVE

FREE CATALOG & INFORMATION (213) 888-8988

FAX (213) 888-6868

▲ indicates the level of difficulty in the assembling of our Products. ▲ Beginner ▲▲ Intermediate ▲▲▲ Advanced ★ Fully Assembled

| Model | TA-3600 | TA-477 | TA-802 | TA-1000A | TA-1500 |
|-----------------|----------|----------|----------|----------|----------|
| Amplifier | TA-3600 | TA-477 | TA-802 | TA-1000A | TA-1500 |
| + Metal Cabinet | LG-1925 | LG-1925 | LG-1924 | LG-1924 | LG-1925 |
| + Transformer | #007 | #003 | #001 | #001 | #001 |
| Kit Set | \$155.61 | \$125.21 | \$100.45 | \$113.52 | \$130.00 |
| Assmb. Set | \$179.36 | \$141.36 | \$113.54 | \$133.36 | \$150.00 |

• Due to this special offer & low price, we can only exchange or repair any of these units (TA-3600, TA-477, TA-802 & TA-1000A) within 15 days of your receipt.
• The above prices are for the complete sets. For separate unit price, please see below.



| MODEL | DESCRIPTION | KIT | ASSEMB. |
|------------|--|---------|---------|
| TA-28MK2 | Digital Voice Memo ▲▲ | \$30.00 | |
| TA-50A / B | Multi-Purpose Melody Generator ▲ | 12.84 | 17.20 |
| TA-50C | Multi-Purpose Melody (Happy Birthday, Wedding March, etc.) Generator ▲ | 13.65 | 18.71 |
| TA-120MK2 | 35W Class "A" Main Power Mono Amp ▲ | 31.50 | 42.80 |
| TA-300 | 30W Multi-Purpose Single Channel Amp ▲ | 20.00 | 29.00 |
| SM-302 | 60W + 60W Stereo Power Amplifier (with Mic input) ▲▲ | 67.00 | 78.00 |
| TA-323A | 30W X 2 Stereo Pre-main Amp. ▲ | 31.50 | 42.80 |
| TA-377A | State of the Art Fully Complementary Symmetrical FET Pre-Amp ▲▲▲ | 59.95 | 75.00 |
| TA-400 | +0W Solid State Mono Amp. ▲ | 28.00 | 34.93 |
| TA-477 | 120W Mosfet Power Mono Amp. ▲▲ | 68.00 | 85.00 |
| TA-800MK2 | 120W + 120W Low Tim Pre-Main Stereo Power Amp. ▲▲ | 63.92 | |
| TA-802 | 80W + 80W Pure DC Stereo Main Power Amp. ▲▲ | 45.94 | 59.72 |
| TA-1000A | 100W Dynamic Class "A" Main Power Mono Amp. ▲ | 59.69 | 80.58 |
| TA-1500 | 100W X 2 Class "A" DC Stereo Pre-Main Amp. ▲▲▲ | 73.70 | 95.81 |
| TA-2200 | DC Fet Super Class "A" DC Pre-Amp. ▲▲ | 47.70 | 58.24 |
| TA-2400A | Electronic Echo & Reverberation Amp. ★ | | 96.00 |
| TA-2500 | HQ Pre-Amp w/10 band graphic equalizer ★ | | 68.80 |
| TA-2800 | BI-FET IC Pre-Amp w/3 way tone control ▲ | 48.90 | 63.57 |
| TA-3000 | Stereo Simulator (For Mono TV or Any Mono Source) ▲▲ | 27.00 | 38.50 |
| TA-3600 | 300W HQ Hi-Fi Power Mono Amp. ▲ | 85.00 | 110.00 |
| SM-222 | 7 Band HI-FI Graphic Equalizer ▲ | 26.80 | 38.80 |
| SM-328 | 4 Channel Professional Color Light Controller ★ | | 115.00 |
| SM-333 | Audio/Video Surround Sound Processor ▲▲▲▲ | 65.00 | 75.00 |
| SM-666 | Dynamic Noise Reduction ▲ | 26.00 | 34.00 |
| SM-888 | Universal Audio/Video KARAOKE Mixer, Pre-Amp. ★ | | 225.00 |

| MODEL | DESCRIPTION | KIT | ASSEMB. |
|----------|---|---------|---------|
| SM-43 | 3 1/2 Multi-Functional Led D.P.M. (w/ABS plastic case) ▲▲ | \$34.50 | \$43.00 |
| SM-48 | 4 1/2 Hi-Precision D.P.M. ▲▲▲ | 38.00 | 48.00 |
| SM-48A | 4 1/2 Hi-Precision D.P.M. (w/ABS plastic case) ▲▲▲ | 41.20 | 52.00 |
| SM-49 | 3 1/2 Multi-Functional LCD D.P.M. (w/hold Function) ▲▲ | 36.00 | 44.50 |
| SM-100 | 150MHz Digital Frequency Counter ▲ | 79.00 | 90.00 |
| FC-1000A | 1 GHz Frequency Counter ★ | | 179.00 |

| MODEL | DESCRIPTION | KIT | ASSEMB. |
|----------|--|-------|---------|
| TV-23B | 3 Channel Color Light Controller ★ | \$ | \$65.00 |
| TV-25 | Stereo Loudspeaker Protector ▲ | 14.85 | 20.85 |
| TV-35 | FM Wireless Microphone ▲ | 11.25 | |
| TV-36 | AC/DC Quartz Digital Clock ▲ | 19.00 | 26.20 |
| TV-38 | Sound / Touch Control Switch ▲ | 12.00 | |
| TV-41MKV | Infrared Remote Control Unit (w/Case) ▲▲▲ | 22.00 | 35.00 |
| TV-42 | Bar / Dot Level Meter ▲▲ | 24.15 | 33.81 |
| TV-43 | 3 1/2 Digital Panel Meter ▲ | 29.00 | 38.00 |
| TV-45 | 20 Steps Bar / Dot Audio Level Display ▲▲ | 38.45 | 46.14 |
| TV-47 | Superior Electronic Roulette ▲▲ | 19.46 | 27.24 |
| 10,000uF | 80V Capacitor (Suggested for TA-3600, TA-477, TA-1000A & TA-802) | | 23.00 |

| MODEL | DESCRIPTION | KIT | ASSEMB. |
|---------|--|---------|---------|
| TR-355A | 0-15V 5A Regulated DC Power Supply (no case & x'former) ▲ | \$15.65 | \$21.76 |
| TR-355B | 0-30V 3A Regulated DC Power Supply (no case & x'former) ▲ | 15.65 | 21.76 |
| TR-503 | 0-50V 3A Regulated DC Power Supply (no case & x'former) ▲▲ | 16.75 | 23.65 |

| MODEL | H" x W" x D" | MATCHING | PRICE |
|---------|-------------------|--|---------|
| LG-1273 | 3" x 12" x 7" | TA-2800, TA-377A, TA-2200 | \$22.85 |
| LG-1684 | 4" x 16" x 8" | TA-323A, TA-377A, TA-2200 | 27.50 |
| LG-1924 | 4" x 19" x 1 1/2" | TA-802, TA-1500, TA120MK 2, TA-800 MK2, TA-1000A | 32.80 |
| LG-1925 | 5" x 19" x 1 1/2" | TA-477, TA-800, MK2, TA-1500, TA-1000A, TA-3600 | 35.80 |
| LG-1983 | 2 3/4" x 19" x 8" | TA-377A, TA-2800, TA-2200, TA-120MK 2 | 29.25 |

| MODEL | DESCRIPTION | MATCHING | PRICE |
|-------|--------------------------|--|---------|
| 001 | 28V x 2 6A to 30V x 2 6A | TA-800 MK2, TA-802, TA-820A, TA-1000A, TA-1500 | \$27.00 |
| 002 | 36V x 2 3A | TR-503, TA-323A, TA-400, TA-300, TA-377A | 22.00 |
| 003 | 40V x 2 6A | TA-477 | 28.00 |
| 004 | 24V x 2 6A | TA-120 MK 2 | 22.00 |
| 005 | 28V x 2 3A | TR-355B | 16.00 |
| 006 | 18V x 2 5A | TR-355A | 15.50 |
| 007 | 53V x 2 8A | TA-3600 | 43.00 |

We accept major Credit Cards. Money Orders, Checks and C.O.D. Orders. C.O.D. fee is \$5.00. Minimum order is \$20.00. • Ship by UPS ground inside US (min. \$3.00) and ship by US mail Business & Showroom hours: (Pacific Time) out of US. Please call our sales department for orders over 2 lbs. or foreign orders. • All assembled units have a 30 days warranty. • Quality or Volume discount available upon request. • Residents Mon. thru Fri. 9:30 am to 5:00 pm of CA please add sales tax 6.75%. • All merchandise checks are subject to prior sale. Prices are subject to change without prior notice. We are not responsible for typographical errors. Sat. 10:00 am to 5:00 pm

MARK V ELECTRONICS, INC. — 8019 E. Slauson Ave, Montebello, CA 90640

CIRCLE 93 ON FREE INFORMATION CARD

www.americanradiohistory.com

BEST BY MAIL
Rates: Write National, Box 5, Sarasota, FL 34230

OF INTEREST TO ALL

SHOP BY MAIL Catalog \$5: Gifts N Things, Box 234, Sac, IA 50583.

LOW INTEREST VISA. Free application. Box 16801(RE), Jacksonville, Florida 32245-6801.

CIGARETTES 30 CENTS Pack. Sources \$2.00. IRWIN, Box 2096(EE), Baytown, TX 77522-2096.

GUARANTEED LOANS! PERSONAL. Business. No Credit Check! Prompt. Professional. (212)323-8006.

PERSONAL-MISCELLANEOUS

ROMANTIC INTRODUCTIONS. CONFESSIONS. Fantasies. Secrets. All Lifestyles. 1-900-FUN-1990. \$1.95 minute.



Let's close the book on forest fires.

Ad Council A Public Service of This Magazine & The Advertising Council

★★★★PRESENTING★★★★
CABLE TV DESCRAMBLERS
★★★★ STARRING ★★★★★
JERROLD, HAMLIN, OAK
AND OTHER FAMOUS MANUFACTURERS

- FINEST WARRANTY PROGRAM AVAILABLE
- LOWEST RETAIL / WHOLESALE PRICES IN U.S.
- ORDERS SHIPPED FROM STOCK WITHIN 24 HRS.
- ALL MAJOR CREDIT CARDS ACCEPTED

FOR FREE CATALOG ONLY 1-800-345-8927
FOR ALL INFORMATION 1-818-709-9937

PACIFIC CABLE CO., INC.
7325 1/2 Reseda Blvd., Dept. 2105
Reseda, CA 91335

CABLE TV DESCRAMBLER LIQUIDATION!
FREE CATALOG!
Hamlin Combos \$44, Oak M35B \$60 (min. 5), etc.
WEST COAST ELECTRONICS
For Information: 818-709-1758
Catalogs & Orders: 800-628-9656

ZENITH & TOCOM SPECIALS

SUPER Zenith (Z-TAC) converters (w/flash-guard)... \$179.00. Zenith "turn-on" module... \$49.00. Tocom 5503(A) converters... Call. Tocom (5503-VIP/5503(A)/5507) "turn-on" chips... \$49.00. Tocom 5507 & Jerrold (security screw removal tool)... \$22.00. CINEPLEX VIDEO GROUP. 1 (800) 726-4627.

AUTOMOTIVE

IS it true... jeeps for \$44.00 through the U.S. gov't? For facts! (504) 649-5745 ext. S-5192.

CABLE BOXES BELOW WHOLESALE GUARANTEED STOCK - COD'S

- DESCRAMBLERS -

| | | | | |
|--------|------|------|------|-------|
| (QTY) | (10) | (20) | (50) | (100) |
| TB 2-3 | 45 | 40 | 36 | 33 |
| SA3-B | 45 | 40 | 36 | 33 |
| XN12 + | 43 | 38 | 34 | 29 |
| SB 2-3 | 43 | 38 | 34 | 30 |

60 CH REMOTE CONV/DECODER

| | | | | |
|---------|----|----|----|----|
| DRX-DIC | 90 | 75 | 70 | 65 |
| SYL DIC | 75 | 60 | 50 | 45 |

- CONVERTERS W/REMOTES -

PANASONIC TZPC145
5 YR. WAR. + PARENTAL + 86 CH
TIMER + MEMORY + CH 2 OR 3 +
NEW 70 65 61 57

REFURB 60 CH WIREMOTE
S-4040 38 36 34 31

HAMLIN-ZENITH-TOCOM-CALL

IT IS NOT THE INTENT OF LAKE SYLVAN SALES TO DEFAUD ANY CABLE TELEVISION OPERATOR. FEDERAL AND STATE LAWS PROVIDE SUBSTANTIAL PENALTIES FOR THEFT OF CABLE TELEVISION SERVICES

LAKE SYLVAN SALES, INC.
SORRY, NO MINNESOTA SALES

800-800-4582
DESCRAMBLERS PLUS!
CIRCLE 187 ON FREE INFORMATION CARD

12" Subwoofer Box **12" Pioneer Subwoofer** **800 Hz Horn** **18" Eminence Woofer**

The perfect high volume cabinet for dual voice coil subwoofers. Box comes with pre-cut woofer and port holes. Cabinet volume: 2 cu. ft. with dual ports. Charcoal carpet. Dimensions: 13" (H) x 13" (D) x 30" (W). Net weight: 29 lbs.

#RJ-260-495 \$59⁹⁰ Each

12" super duty. dual voice coil subwoofer. 30 oz. magnet, 2" voice coil. 100 watts RMS, 145 watts max power handling capability. 6 ohm impedance (4 and 8 ohm compatible). Sensitivity: 89 dB 1W/1M. Response: 25-700 Hz. QTS= 31, VAS= 10.3 cu ft. Net weight: 6 lbs. Pioneer #A30GU30-55D.

#RJ-290-145 \$39⁸⁰ \$36⁸⁰ (1-3) (4-up)

Piezo midrange/tweeter driver unit. Response: 800-20 KHz. Power handling capability: 20-30 volts (approximately 50 watts RMS). Sensitivity: 93 dB, 2 83V/1M. 4" round. Motorola #KSN1086.

#RJ-270-085 \$25³⁰ \$23⁹⁵ (1-3) (4-up)

Professional driver for use in auditorium and studio sound systems. Giant 100 oz magnet. 250 watts RMS, 350 watts max power handling capability. fs= 30 Hz, QMS= 3.17, QES= 373, QTS= 33, VAS= 10.5 cu ft. SPL= 95 dB 1W/1M. Net weight: 29 lbs.

#RJ-290-200 \$99⁸⁰ \$93⁴⁰ (1-3) (4-up)

12" Pyle Woofer **5-1/2" Cone Midrange** **Subwoofer Crossover Network**

12". 70 oz. magnet woofer. 2-1/2" voice coil. 105 watts RMS, 155 watts max power handling capability.

#RJ-292-050 \$62⁹⁰ \$59⁸⁰ (1-5) (6-up)

Original Sanyo high-end system midrange. Large 5" paper cone with gold look dust cap. Heavy 12 oz. magnet. 1" ferro fluid cooled voice coil. 50 watts RMS, 75 watts max. Sanyo part #S12H10. Net weight: 1-1/2 lbs.

#RJ-281-100 \$5⁹⁵ \$3⁹⁵ (1-9) (10-up)

Super duty, 200 watt RMS power handling capability. Designed specially for dual voice coil subwoofer systems. 12 dB per octave roll-off at 150 Hz into 8 ohms. Crossover also features a set of outputs for use with your existing speaker system. Network is totally passive, requiring no power source of its own.

#RJ-260-220 \$28⁸⁰ \$24⁹⁵ (1-5) (6-up)

NEW REVISED CATALOG

Parts Express

• 15 day money back guarantee • \$15.00 minimum order • We accept Mastercard, Visa, Discover, and C.O.D. orders. • 24 hour shipping • Shipping charge = UPS chart rate + \$1.00 (\$3.00 minimum charge) • Hours 8:30 am - 7:00 pm EST, Monday - Friday • 9:00 am - 2:00 pm Saturday. Mail order customers, please call for shipping estimate on orders exceeding 5 lbs. Foreign customers please send \$5.00 U.S. funds for catalog postage.

CALL TOLL FREE 1-800-338-0531

FREE CATALOG

Parts Express International Inc.
340 E. First St., Dayton, Ohio 45402
Local: 1-513-222-0173
FAX: 513-222-4644

CIRCLE 56 ON FREE INFORMATION CARD

CABLE TV EQUIPMENT

Converters, Remote Controls,
Descramblers, CD Players.



**JERROLD-OAK-SCIENTIFIC ATLANTA-HAMLIN
ZENITH MANY MORE CALL TODAY!**

- √ Only quality products sold
- √ Easy to use
- √ Satisfaction guaranteed
- √ Knowledgeable sales staff
- √ Most orders shipped within 24 hours

CALL FOR YOUR FREE CATALOG

MC 1-800-228-7404 VISA

MAKE THE CONNECTION

**WITH
NU-TEK ELECTRONICS**

5114 Balcones Wood Dr.#307 Dept.298
Austin, TX. 78759

WHY PAY SKY HIGH MONTHLY ★ RENTALS ★



If you find a better deal, We'll beat it!
**JERROLD • TOCOM • HAMLIN • OAK
• SCIENTIFIC ATLANTA • ZENITH •**
ask about our warranty program C.O.D.
Visa, M/C, A.M.E.X. welcome. **FREE
CATALOG • FREE CALL • OPEN SAT-
URDAYS**

GTV 1464 Garner Station Blvd #315 Raleigh,
NC 27603

1 800 328-0198

PAY TV AND SATELLITE DESCRAMBLING ALL NEW 1991 EDITION

Our best yet. The very latest in descrambling circuits, bypasses, turn-ons for cable, wireless and satellite. Only \$14.95. Other pay TV editions, Vol. 1 (Basics of All Systems) \$14.95. 1989 Edition \$14.95. Build satellite systems under \$600 \$12.95. Wireless Cable Handbook \$9.95. Any 3/\$29.95 or 5/\$44.95. Scrambling News Monthly has all info on the new "Plain Vanilla" descramblers which emulate B-Mac, VCII, Plus and Orion. \$19.95/yr. All new catalog \$1.

Scrambling News, 1552 Hertel Ave.,
Buffalo, NY, 14216. COD'S ARE OK. (716) 874-2088

RADON. THE HEALTH HAZARD IN YOUR HOME THAT HAS A SIMPLE SOLUTION.

Call
1-800-SOS-RADON
to get your Radon
test information.



EDUCATION & INSTRUCTION

**F.C.C. Commercial General Radiotelephone li-
cense.** Electronics home study. Fast, inexpensive!
"Free" details. **COMMAND, D-176, Box 2824, San
Francisco, CA 94126.**

COMPLETE course in electronic engineering. Eight
volumes. Includes all necessary math and physics.
Free brochure. **BANNER TECHNICAL BOOKS,**
1203 Grant Avenue, Rockford, IL 61103.

UNICORN - YOUR I.C. SOURCE & MUCH, MUCH MORE!

Laser Diode (visible-red)



- Output: 3 mW (max.)
- Current: 85-100 mA
- Op. Volt.: 2.3-3.0V
- Wavelength: 670NM
- Lens Required
- Data Sheet & Application notes inc.

Laser Diode (visible red)



- Output: 5 mW (max.)
- Current: 65-100 mA
- Op. Volt.: 1.75-2.2V
- Wavelength: 780NM
- Lens Required
- Data Sheet & Application notes inc.

Laser Diode (visible red)



- Output: 4 mW (max.)
- Current: 20 mA
- Op. Volt.: 2.3-3.0V
- Wavelength: 670NM
- Lens Required
- Data Sheet & Application notes inc.

Laser Diode (visible red)



- Output: 5 mW (max.)
- Current: 60 mA
- Op. Volt.: 2.3-3.0V
- Wavelength: 670NM
- Lens Required
- Data Sheet & Application notes inc.

Laser Diode (Infra-red)



- Output: 3 mW (max.)
- Current: 85-100 mA
- Op. Volt.: 2.3-3.0V
- Wavelength: 820NM
- Lens Required
- Data Sheet inc.

STOCK # **LS9200** PRICE **\$49.99**

STOCK # **LS022** PRICE **\$19.99**

STOCK # **SB3200** PRICE **\$89.99**

STOCK # **LS9211** PRICE **\$69.99**

STOCK # **SB1053** PRICE **\$9.99**

Collimator Pen (Infra-red)



- Output: 2.5 mW (max.)
- Current: 90-150 mA
- Op. Volt.: 2.2-2.5V
- Wavelength: 820NM
- Data Sheet inc.

Laser Pointer



- Output: 3.5 mW
- Wavelength: 670NM
- Power Supply: 2xAAA
- Batteries (included)
- Beam: Approx. 3" @ 100 yards
- Quantity Discounts Available

Power Supply



- Input: 115/230V
- Output: +5v @ 3.75A
- +12v @ 1.5A
- 12v @ 4A
- Size: 7" L x 5 1/4" W x 2 1/2" H

STOCK # **LB1052** PRICE **\$39.99**

STOCK # **LSPOINT** PRICE **\$199.99**

STOCK # **PS1003** PRICE **\$19.99**

Disc Drive & Computer Cleaning Kit



Not just a drive cleaner, but a complete computer cleaning kit. Includes swabs, head cleaning fluid, anti-static cleaner, screen wipes and cleaning diskette.

Disc Drive Head- Cleaning Kit



Includes cleaning fluid and head-cleaning fluid

Anti-Static Screen Wipes



For static-sensitive applications. Dispenser packs, individually wrapped.

STOCK # **SB1099** 3 1/2" Kit PRICE **\$6.99**
STOCK # **SB1100** 5 1/4" Kit PRICE **\$6.99**

STOCK # **SB1105** 3 1/2" Drive Kit PRICE **\$1.99**
STOCK # **SB1106** 5 1/4" Drive Kit PRICE **\$1.99**

STOCK # **SB1104** PRICE
Dispenser pack of 25 wipes
STOCK # **SB1106** PRICE
Dispenser pack of 100 wipes



10010 Canoga Ave., Unit B-8 • Chatsworth, CA 91311
OUTSIDE CALIFORNIA: (800) 824-3432 (Orders Only)
IN CALIFORNIA: (818) 341-8833
ORDER BY FAX: (818) 998-7975

Minimum Order \$15.00 • 24-hour ordering available

EPROMS

| STOCK # | 1-24 | 25-99 | 100+ | STOCK # | 1-24 | 25-99 | 100+ |
|----------|------|-------|------|----------|-------|-------|-------|
| 1702 | 4.59 | 4.36 | 3.92 | 2764A | 3.49 | 3.32 | 2.99 |
| 2708 | 6.49 | 6.17 | 5.55 | TMS2564 | 5.79 | 5.50 | 4.95 |
| 2716 | 3.29 | 3.13 | 2.82 | 27C64 | 3.29 | 3.13 | 3.28 |
| 2716-1 | 3.79 | 3.60 | 3.24 | 27128-20 | 4.99 | 4.74 | 4.27 |
| TMS2716 | 5.79 | 5.50 | 4.95 | 27128 | 4.79 | 4.55 | 4.09 |
| 27C16 | 3.99 | 3.79 | 3.41 | 27128A | 4.79 | 4.55 | 4.09 |
| 2732 | 4.19 | 3.98 | 3.58 | 27C128 | 4.79 | 4.55 | 4.09 |
| 2732A-2 | 3.79 | 3.60 | 3.24 | 27256-20 | 5.29 | 5.03 | 4.53 |
| 2732A | 3.69 | 3.51 | 3.16 | 27256 | 4.79 | 4.55 | 4.09 |
| 2732A-4 | 3.19 | 3.03 | 2.73 | 27C256 | 4.29 | 4.08 | 3.67 |
| TMS2532 | 5.79 | 5.50 | 4.95 | 27512-20 | 6.49 | 6.17 | 5.55 |
| TMS2532P | 1.99 | 1.89 | 1.70 | 27512 | 5.99 | 5.69 | 5.12 |
| 27C32 | 3.79 | 3.60 | 3.24 | 27C512 | 5.99 | 5.69 | 5.12 |
| 2764-20 | 4.29 | 4.08 | 3.67 | 27C1024 | 12.99 | 12.34 | 11.11 |
| 2764 | 3.99 | 3.79 | 3.41 | 68764 | 13.99 | 13.29 | 11.96 |
| 2764A-20 | 3.99 | 3.79 | 3.41 | 68766 | 12.99 | 12.34 | 11.11 |

DYNAMIC RAMS

| STOCK # | 1-24 | 25-99 | 100+ | STOCK # | 1-24 | 25-99 | 100+ |
|----------|------|-------|------|------------|------|-------|------|
| MK4027 | .59 | .56 | .50 | 4464-100 | 2.99 | 2.84 | 2.56 |
| 4116-120 | 1.39 | 1.32 | 1.19 | 4464-120 | 2.79 | 2.65 | 2.39 |
| 4116-150 | .99 | .94 | .85 | 4464-150 | 2.29 | 2.13 | 1.96 |
| 4116-200 | .89 | .85 | .77 | 41256-60 | 2.99 | 2.84 | 2.56 |
| 4116-250 | .59 | .56 | .50 | 41256-80 | 2.79 | 2.65 | 2.39 |
| 4164-100 | 1.89 | 1.80 | 1.63 | 41256-100 | 1.99 | 1.89 | 1.70 |
| 4164-120 | 1.69 | 1.61 | 1.55 | 41256-120 | 1.89 | 1.80 | 1.63 |
| 4164-150 | 1.59 | 1.51 | 1.36 | 41256-150 | 1.79 | 1.70 | 1.53 |
| 4164-200 | 1.39 | 1.32 | 1.19 | 511000-70 | 6.49 | 6.17 | 5.55 |
| 4416-120 | 1.99 | 1.89 | 1.70 | 511000-80 | 5.99 | 5.69 | 5.12 |
| 4416-150 | 1.79 | 1.70 | 1.53 | 511000-100 | 5.49 | 5.22 | 4.70 |

MULTIMETERS

with TEST LEADS and BATTERIES INCLUDED



KELVIN PRO 400

KELVIN DIGITAL MULTIMETERS
 KELVIN 100 Basic \$19.95
 KELVIN 150 Basic+ \$29.95
 with Transistor Hfe Test
 KELVIN 200 Advanced \$39.95
 w/Transistor Hfe, Capacitor Test
 KELVIN PRO 400 \$69.95
 w/Transistor, Capacitor, AC/DC Test, Logic, 20 MHz Freq Counter, Durable

Kelvin Meters backed by a 2 Yr Warranty - Parts & Labor
 Protective Case \$4.95
 For Model 100, 150, 200
 Protective Case \$9.95
 For Model Pro 400

FLUKE



ALL FLUKE METERS COME WITH 3 YEAR WARRANTY

FLUKE 87

BEST BUY NEW Series II

| | |
|--------------------|-------|
| FLUKE 70 Series II | \$ 63 |
| FLUKE 73 Series II | \$ 89 |
| FLUKE 75 Series II | \$127 |
| FLUKE 77 Series II | \$149 |
| FLUKE 79 Series II | \$169 |
| FLUKE 83 | \$199 |
| FLUKE 85 | \$229 |
| FLUKE 87 | \$269 |
| FLUKE 86 | \$367 |
| FLUKE 88 | \$423 |
| FLUKE 8062A | \$329 |
| FLUKE 8060A | \$395 |
| FLUKE 8010A | \$329 |
| FLUKE 8012A | \$359 |
| FLUKE 8050A | \$439 |
| FLUKE 37 | \$249 |
| FLUKE 45 | \$579 |

SCOPES

20 MHz SCOPE \$375
 with Built-In Component Tester
 2 Yr Warranty - Parts & Labor
 HITACHI V523 50 MHz \$995
 50 MHz, Analog 2 Ch, 1 mV, Delay Sweep, DC Offset, Vert Mode Trigger
 3 Yr Warranty - Parts & Labor



HITACHI V523

SCOPE PROBES

60 MHz, X1 & X10
 700072 \$19.95
 150 MHz, X10
 700073 \$39.95

BREADBOARDS

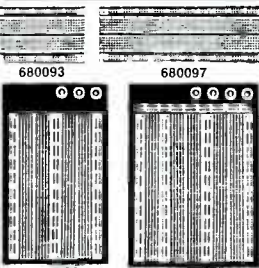

| | | | |
|-----------|--------|----------|-----------|
| 680093 | 680097 | | |
| 680098 | 680100 | | |
| Stock No. | Post | Contacts | YOUR COST |
| 680093 | 0 | 500 | \$ 4.25 |
| 680097 | 0 | 840 | \$ 5.95 |
| 680098 | 2 | 1380 | \$11.75 |
| 680100 | 4 | 2390 | \$22.95 |

WIRE JUMPER KIT
 Pre-cut, Pre-Stripped
 330289 140 Piece Set ... \$ 4.75
 330290 350 Piece Set ... \$ 7.75

COMPONENTS

| | | |
|--------|------------------------------------|-----------|
| 600021 | 555 TIMER | \$.20 EA |
| 600029 | 556 DUAL TIMER | \$.40 EA |
| 600039 | LM565 PLL FUNCTION GENERATOR | \$.60 EA |
| 600018 | 741C OP-AMP INTERNALLY COMPENSATED | \$.30 EA |
| 600026 | 1458 OP-AMP DUAL 741C OP-AMP DIP | \$.35 EA |
| 630041 | 2N2222 | \$.18 EA |
| 630383 | PN2222 | \$.08 EA |
| 600023 | 7805 VOLTAGE REG | \$.36 EA |

SILICON CONTROLLED RECTIFIER
 (Similar to GE C106C1) 4.0 AMP, 100 PIV
 600014 \$.89 EA \$.79 EA-50+

TEST ACCESSORIES

IC CLIPS
 SOLDER TYPE SPRING LOADED
 Stock No. COLOR COST 25+ Qty
 990104 BLACK \$.65 ea \$.50 ea
 990105 RED \$.65 ea \$.50 ea

IC TEST LEAD SET
 5 COLOR CODED 18" LEADS WITH MINATURE HOOK-ON PROD. AT BOTH ENDS
 Stock No. YOUR COST 3+ Qty
 990108 \$8.95 ea \$8.25 ea

DOUBLE BANANA JACK
 Stock No. YOUR COST 3+ Qty
 600056 \$2.30 ea \$2.07 ea

FEMALE BNC TO DUAL BANANA PLUG
 Stock No. YOUR COST 3+ Qty
 990103 \$2.95 ea \$2.75 ea

DUAL BANANA BINDING POST TO MALE BNC PLUG
 Stock No. YOUR COST 3+ Qty
 600058 \$5.95 ea \$4.95 ea

BNC TEST CABLES 3 FT.
 MALE TO MALE
 Stock No. YOUR COST 3+ Qty
 990101 \$3.45 ea \$2.95 ea

NI-CAD BATTERY CHARGER
 4 Cell Charger for AAA, AA, C, D or 9V
 Stock No. YOUR COST
 220035 SPECIAL \$9.95 ea

RESISTORS

5% Tolerance Carbon Film

CALL WITH YOUR VALUE
 1/4 W \$2 / 200 Pcs
 1/2 W \$3 / 200 Pcs
 1 W \$1.30 / 10 Pcs
 2 W \$1.70 / 10 Pcs

LUBES/CLEANERS

WD-40 LUBRICANT
 12 OZ. CAN Stock No. 870001 \$2.95 ea
 \$2.80 ea / 3+ Qty

MINUS BLUE SHOWER CLEANER & DEGREASER
 24 OZ. SPRAY CAN Stock No. 510007 \$8.95 ea
 \$8.25 ea / 3+ Qty

MINUS 62 INSTANT CHILLER SPRAY
 15 OZ. SPRAY CAN Stock No. 510004 \$5.95 ea
 \$5.25 ea / 3+ Qty

TRANSISTOR SILICON GREASE
 1 OZ. TUBE Stock No. 510002 \$5.50 ea
 \$4.95 ea / 3+ Qty

WALL TRANSFORMERS

WALL TRANSFORMER
 STOCK NO. TYPE - Female
 220069 9V DC/500 mA \$3.95 ea
 220068 12V DC/500 mA \$4.25 ea

MALE JACK
 STOCK NO. TYPE
 370048 2.1 mm Male \$.49 ea \$.39 /10+

BATTERIES

Duracell / Eveready 9V Alkaline Battery
 \$ 1.95 ea
 \$ 1.75 ea/10+

9V Battery SNAP & HOLDER
 Snap \$.15 ea \$.10 ea/100+
 Holder \$.20 ea \$.10 ea/100+

HEAVY DUTY NI-CAD RECHARGEABLE BATTERIES
 STOCK NO. TYPE YOUR COST
 220039 AAA \$3.30 ea
 220025 AA \$2.85 ea
 220027 C \$6.00 ea
 220037 D \$6.00 ea
 220038 9V \$8.90 ea

LED CENTER

SPECIAL - RED LED - \$.05 ea / 1000+ Qty
JUMBO LED
 TYPE - T 1 3/4, 5mm
 STOCK NO. YOUR COST 1000+ Qty
 260020 Red \$.06 ea/100+ \$.05 ea
 260027 Green \$.08 ea/100+ \$.07 ea
 260026 Yellow \$.08 ea/100+ \$.07 ea

LED HOLDER
 for T 1 3/4 SIZE, BLACK
 Stock No. 250019
 \$.10 ea / 100+ Qty
 \$.06 ea / 1000+ Qty

0.37" 7 SEGMENT LED READOUT
 STOCK NO. TYPE COST
 260022 Anode \$.95 ea \$.75 ea
 260090 Cathode \$1.25 ea \$.99 ea

0.6" 7 SEGMENT LED READOUT
 STOCK NO. Anode Jumbo COST
 260021 \$1.15 ea \$.99 ea
 20+ Qty

TIL 311 4 X 7 HEXIDECIMAL DISPLAY
 STOCK NO. 260066
 YOUR COST \$12.95 ea

RED LED DISPLAY BAR GRAPH
 20 PIN
 STOCK NO. Color YOUR COST 10+ Qty
 260058 Red \$1.99 ea \$1.79 ea
 260088 Green \$1.99 ea \$1.79 ea
 260089 Yellow \$1.99 ea \$1.79 ea

MOVING SIGN DISPLAY
 for Fabricating Your Own Moving Sign Display
 50 mm STOCK NO. 260091
 \$5.95 ea
 \$5.45 ea 20+

RED LED DISPLAY BAR GRAPH
 20 PIN
 STOCK NO. Color YOUR COST 10+ Qty
 260058 Red \$1.99 ea \$1.79 ea
 260088 Green \$1.99 ea \$1.79 ea
 260089 Yellow \$1.99 ea \$1.79 ea

MOVING SIGN DISPLAY
 for Fabricating Your Own Moving Sign Display
 50 mm STOCK NO. 260091
 \$5.95 ea
 \$5.45 ea 20+

TOOLS

MINIATURE LONG NOSE PLIERS
 4 1/2" LONG, INSULATING HANDLES, DROP FORGED STEEL, FULLY MILLED JAWS
 Stock No. 520021 \$3.95 ea
 \$3.50 ea / 6+ Qty

MINIATURE DIAGONAL CUTTER
 4 1/2" LONG, CUSHIONED HANDLES, DROP FORGED STEEL
 Stock No. 520023 \$3.95 ea
 \$3.45 ea / 6+ Qty

MILLER WIRE CUTTER & STRIPPER
 MODEL 100 ADJUSTABLE GRIPPING HANDLES INSULATED
 Stock No. 520010 \$2.95 ea
 \$2.66 ea / 6+ Qty

DELUXE WIRE STRIPPER & CRIMPING TOOL
 CRIMPS REGULAR & INSULATED TERMINALS CUTS & STRIPS WIRE
 Stock No. 520065 \$3.60 ea
 \$3.42 ea / 6+ Qty

PROJECT PARTS

Project Speaker
 2", 8 Ohm, 1 Watt
 Stock No. 350009
 59¢

Project BUZZER
 3 - 9 Volt DC, 80 db
 Stock No. 680089
 \$1.59 ea
 \$1.39 ea / 10+ Qty

HORN ALARM
 Loud Penetrating Sound
 Stock No. 640001
 \$.75 ea
 \$.69 ea / 10+ Qty

DC MOTOR
 for SOLAR/ROBOTIC
 Stock No. 852211
 \$.50 ea
 \$.45 ea / 20+ Qty

SOLAR CELL
 3/4" x 1 1/2", .45V DC, 150 mA, wired/encased
 Stock No. 260056
 \$6.95 ea

XENON STROBE TUBE
 Stock No. 260050
 \$2.95 ea
 \$2.50 ea / 20+ Qty

TRIGGER COIL
 for Xenon Strobe Tube
 Stock No. 320037
 \$1.25 ea
 \$.89 ea / 20+ Qty

INFRARED LED IR Pair, LED infrared transmitter and receiver
 Stock No. 260061
 \$2.79 ea

NEON LAMP
 NE2, 2" Lead
 Stock No. 260003
 \$.15 ea
 \$.12 ea / 100+ Qty

PHOTO CELL
 CADMIUM SELENIDE
 Stock No. 260017
 \$.99 ea

PHOTO CELL
 SULPHIDE
 Stock No. 260018
 \$.99 ea

PUSH-BUTTON SWITCH
 PUSH-ON, PUSH-OFF
 Stock No. 270021
 \$.55 ea
 \$.49 ea / 100+ Qty

SUB-MINIATURE MOMENTARY SWITCH
 Stock No. 990002
 \$.35 ea
 \$.28 ea / 100+ Qty

MINIATURE TOGGLE SWITCH
 Stock No. 270034
 \$.90 ea Type - SPST
 \$.79 ea / 50+ Qty

CIRCLE RESPONSE CARD OR WRITE FOR OUR CATALOG FULL OF WHOLESALE PRICED ITEMS

KELVIN ELECTRONICS

1991 CATALOG

120 PAGES
FULL OF DISCOUNTS

OVER 10,000 ITEMS IN STOCK

ELECTRONIC COMPONENTS & TECHNOLOGY ACTIVITIES
 VISA & MASTERCARD ACCEPTED
 \$20 MINIMUM ORDER

Perfectly Tuned for

Test/Measurement and Prototype Equipment

51-Piece Electronic Tool Kit

Tools Included in Kit:

- 10" measuring tape
- 5.25" needle nose pliers
- Electric tape
- Utility components box
- 6 piece precision screwdriver set
- 6" long tweezers
- 8 piece hex key wrench set
- 7" brush and scraper
- Digital Multimeter
- Brush
- 7" fine point probe
- Round needle file
- 10 piece screwdriver set: 6 Slotted & 4 Phillips
- 7" slotted probe
- Flat needle file
- 4.5" diagonal cutting pliers



- 6" adjustable wrench
- 30 Watt soldering iron
- 5.5" Stainless steel scissors
- Soldering stand
- Rosin core solder
- 5.25" Flat nose pliers
- Utility knife with extra blade
- Desoldering pump
- 5.25" Bent needle nose pliers
- Carrying case: 17.63"W x 12.5"D x 3.5"H

MS305 \$119.95

Global Specialties ProtoBoard® Design

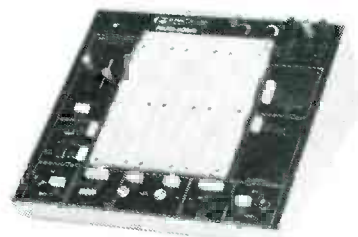

24 Hour
Order Hotline
(415) 592-8097

Features:

- Ideal for analog, digital and microprocessor circuits
- Triple DC regulated power supplies, +5V, +15V, -15V
- 8 logic indicators
- Function generator with sine, square, triangle and TTL waveforms
- Two debounced push-button switches
- Two SPDT slide switches, all leads available and uncommitted
- A total of 2520 uncommitted tie-points
- Potentiometers: one 1KΩ and one 10KΩ
- Includes power supply, instrumentation and breadboarding

PB503..... \$299.95

Jameco Logic Pulser



- Compatible with TTL, DTL, RTL, HTL, HNIL, MOS and CMOS ICs. • 1MΩ Sync input impedance • Pulsar mode output current: 10mA • Square wave current output: 5mA • Audible tone

LP540.....\$16.95

Jameco Logic Probe

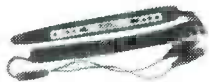

- Max Frequency 80MHz • Minimum detectable pulse: 10ns • 120KΩ input impedance • Max. supply voltage: +25V • TTL threshold: (Lo)+0.8V ±0.1V (Hi) +2.3V -0.2V • CMOS threshold: (Lo) 30% VCC +10% (Hi) 70%VCC ±10%

MS104.....\$24.95

Soldering and Desoldering Stations

60 Watt Analog Display Soldering Station • Electronic temperature control from 200° to 878°F • Cartridge heating element for a longer life of the soldering tip

XY1683.....\$69.95

30 Watt Electronic Temperature Controlled Desoldering Station • Electronic temperature control from 212° to 842°F • Self contained high rotary vacuum pump

XY999.....\$299.95



Prototype Products Jameco Solderless Breadboards

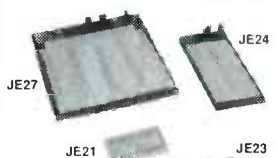

| Part No. | Dim. L" x W" | Contact Points | Binding Posts | Price |
|----------|--------------|----------------|---------------|---------|
| JE21 | 3.25 x 2.125 | 400 | 0 | \$4.95 |
| JE23 | 6.5 x 2.125 | 830 | 0 | \$6.95 |
| JE24 | 6.5 x 3.125 | 1,360 | 2 | \$12.95 |
| JE25 | 6.5 x 4.25 | 1,660 | 3 | \$17.95 |
| JE26 | 6.875 x 5.75 | 2,390 | 4 | \$22.95 |
| JE27 | 7.25 x 7.5 | 3,220 | 4 | \$32.95 |

Metex Digital Multimeters

General Specs:

- Handheld, high accuracy • AC/DC voltage, AC/DC current, resistance, diodes, continuity, transistor hFE
- Manual ranging w/ overload protection



M3650 & M4650 only:
• Also measure frequency and capacitance

M4650 only: • Data hold switch • 4.5 digit

| | | |
|-------|---|---------|
| M3610 | 3.5 Digit Multimeter | \$59.95 |
| M3650 | 3.5 Digit Multimeter w/Frequency & Capacitance | \$74.95 |
| M4650 | 4.5 Digit w/Frequency, Capacitance and Data Hold Switch | \$99.95 |

Handheld Multimeter



- 3.5 digit LCD with automatic polarity indication
- AC/DC voltage measurement up to 500 volts
- AC/DC current measurement up to 200mA
- Resistance measurement up to 20MΩ • Continuity checker with audible tone • Diode and logic tester • Auto/manual range and data hold functions • All range protection and function indications

DMM905.....\$39.95

A.R.T. EPROM Programmer



- Programs all current EPROMs in the 2716 to 27512 range plus the X2864 EEPROM
- RS232 port • Software included

EPP.....\$199.95

UVP EPROM Eraser



- Erases all EPROM's • Erases 1 chip in 15 minutes and 8 chips in 21 min
- UV intensity: 6800 UW/CM²

DE4.....\$89.95

EPROMs - for your programming needs

| Part No. | Price | Part No. | Price | Part No. | Price |
|------------|--------|-----------|--------|-----------|--------|
| TMS2516 | \$4.25 | 2764-20 | \$3.95 | 27256OTP | \$3.75 |
| TMS2532-35 | 9.95 | 2764-25 | 3.75 | 27256-15 | 5.95 |
| TMS2532A | 7.95 | 2764-45 | 3.49 | 27256-20 | 5.25 |
| TMS2564 | 5.95 | 2764A-20 | 3.95 | 27256-25 | 4.75 |
| TMS2716 | 5.95 | 2764A-25 | 3.25 | 27C256-15 | 5.95 |
| 1702A | 3.95 | 27C64-15 | 3.95 | 27C256-20 | 4.95 |
| 2708 | 4.95 | 27C64-25 | 3.25 | 27C256-25 | 4.49 |
| 2716 | 3.49 | 27128OTP | 2.95 | 27512OTP | 4.95 |
| 2716-1 | 3.95 | 27128-20 | 6.95 | 27512-20 | 6.95 |
| 27C16 | 4.25 | 27128-25 | 7.95 | 27512-25 | 5.95 |
| 2732 | 4.95 | 27128A-15 | 5.95 | 27C512-15 | 6.95 |
| 2732A-20 | 4.95 | 27128A-20 | 4.49 | 27C512-20 | 6.49 |
| 2732A-25 | 3.49 | 27128A-25 | 3.75 | 27C512-25 | 5.95 |
| 2732A-45 | 2.95 | 27C128-15 | 5.95 | 27C010-15 | 11.95 |
| 27C32 | 4.95 | 27C128-25 | 7.95 | 68766-35 | 9.95 |

• Partial Listing • Over 4000 Electronic and Computer Components in Stock!

CIRCLE 114 ON FREE INFORMATION CARD

www.americanradiohistory.com

Top Performance

Computer Products and Electronic Components

Assemble Your own Computer Kit!

Jameco 16MHz 80386SX Desktop Computer Kit

- Building your own computer provides you with a better understanding of components and their functions
- In-depth assembly instructions included
- Have your new computer assembled and running in an evening, using common tools
- Software included
- Purchase computer kits configured by Jameco or design your own

JAMECO[®]
ELECTRONIC COMPONENTS

COMPUTER PRODUCTS

24 Hour Order Hotline (415) 592-8097

Relisys 14" VGA Color Monitor



- Max resolution: 720 x 480
- Bandwidth: 30MHz
- Input: DB15-pin (analog)

RE9513.....\$399.95

Jameco 16-bit VGA Card



- Supports VGA, EGA, CGA, MDA and Hercules modes • Comes with 256KB video RAM upgradable to 512KB (eight 41464-100) • Capable of 640 x 480 with 256 colors, 800 x 600 with 16 colors

VG2000.....\$149.95

Hard Drives



Conner (16-bit IDE)

CP3044 40MB 3.5" Low Profile.....\$399.95
CP3184 80MB 3.5"HH.....\$599.95
CP3104 100MB 3.5"HH.....\$649.95

ADP20 Host Adapter.....\$29.95

Look to Jameco.....

- Wide selection of integrated circuits and components
- Quality prototype and test equipment
- Computer kits and accessories

Additional items that Jameco offers:

- Tools
- Cables
- Connectors
- Data Books
- Motherboards
- Memory
- Math Coprocessors
- Computer Accessories
- Power Protection Equipment
- *Much, much more!*

Let us show you what we have to offer, call or write for the latest Jameco catalog!

\$50.00 Minimum Order

Data Sheets - 50c each

Call for a FREE 90-Page catalog!

© 1991 Jameco Electronics 8-91

CA Residents Add

6.00%, 6.50% or 7.00% Sales Tax
Shipping, handling and insurance are additional.
(Costs may vary according to weight and shipping method)
Terms: Prices subject to change without notice.
Items subject to availability and prior sale.

Complete list of terms/warranties is available upon request.
IBM is a registered trademark of International Business Machines

JAMECO[®]
ELECTRONIC COMPONENTS

COMPUTER PRODUCTS

FAX: (415) 592-2503

(415) 595-2664

1355 Shoreway Road
Belmont, CA 94002

\$949.95
JE3816
monitor/adaptor extra

Jameco 16MHz 80386SX Desktop Computer Kit

Includes:

- 80386SX Motherboard with 2MB RAM (expandable to 8MB)
- 101-key enhanced keyboard
- Multi I/O Card
- Toshiba 1.44MB, 3.5" DSHD floppy disk drive
- Baby sized desktop case
- 200 Watt power supply
- DR DOS 5.0 by Digital Research and AMI diagnostic software



Integrated Circuits

| Part No. | 1-9 | 10+ | Part No. | 1-9 | 10+ |
|----------|-------|-------|----------|--------|--------|
| 7400 | \$.29 | \$.19 | 7472 | \$1.95 | \$1.75 |
| 7402 | .29 | .19 | 7473 | .45 | .35 |
| 7404 | .29 | .19 | 7474 | .39 | .29 |
| 7405 | .35 | .25 | 7475 | .49 | .39 |
| 7406 | .39 | .29 | 7476 | .45 | .35 |
| 7407 | .39 | .29 | 7483 | .69 | .59 |
| 7408 | .35 | .25 | 7486 | .45 | .35 |
| 7410 | .29 | .19 | 7489 | 2.95 | 2.75 |
| 7411 | .35 | .25 | 7490 | .49 | .39 |
| 7414 | .35 | .25 | 7493 | .45 | .35 |
| 7417 | .35 | .25 | 74116 | 1.19 | 1.09 |
| 7420 | .29 | .19 | 74121 | .49 | .39 |
| 7427 | .35 | .25 | 74123 | .49 | .39 |
| 7430 | .35 | .25 | 74125 | .49 | .39 |
| 7432 | .39 | .29 | 74151 | .39 | .29 |
| 7438 | .45 | .35 | 74160 | .59 | .49 |
| 7442 | .49 | .39 | 74161 | .69 | .59 |
| 7445 | .75 | .65 | 74192 | .79 | .69 |
| 7446 | .89 | .79 | 74193 | .79 | .69 |
| 7447 | .89 | .79 | 74194 | 1.19 | 1.09 |

Dynamic RAMs

| | | | | | |
|----------|----------------|--------|------------|-----------------|--------|
| 4164-100 | 100ns, 64K x 1 | \$1.95 | 41256-100 | 100ns, 256K x 1 | \$1.99 |
| 4164-120 | 120ns, 64K x 1 | 1.89 | 41256-120 | 120ns, 256K x 1 | 1.89 |
| 4164-150 | 150ns, 64K x 1 | 1.59 | 41256-150 | 150ns, 256K x 1 | 1.85 |
| 41256-60 | 60ns, 256K x 1 | 2.75 | 511000P-80 | 80ns, 1MB x 1 | 7.95 |
| 41256-80 | 80ns, 256K x 1 | 2.49 | 511000P-10 | 100ns, 1MB x 1 | 6.95 |

• Call for a complete listing of IC's

Miscellaneous Components

Potentiometers

Values available (insert ohms into space marked "XX"):
500Ω, 1K, 5K, 10K, 20K, 50K, 100K, 1MEG
43PXX 3/4 Watt, 15 Turn\$.99
63PXX 1/2 Watt, 1 Turn.....\$.89

Transistors And Diodes

PN2222.....\$.12 1N4735.....\$.25 2N4401.....\$.15
PN2907.....\$.12 2N3904.....\$.12 1N4148.....\$.07
1N4004.....\$.10 1N751.....\$.15 2N3055.....\$.69
2N2222A.....\$.25 C106B1.....\$.59 1N270.....\$.25

Switches

JMT123 SPDT, On-On (Toggle)\$1.25
206-8 SPST, 16-pin (DIP).....\$1.09
MPC121 SPDT, On-Off-On (Toggle).....\$1.19
MS102 SPST, Momentary (Push-Button)\$.39

D-Sub Connectors and Hoods

DB25P Male, 25-pin.....\$.65 DB25H Hood\$.39
DB25S Female, 25-pin...\$.75

LEDs

XC209R T1, (Red).....\$.14 XC556R T1³/₄, (Red)....\$.12
XC556G T1³/₄, (Green)....\$.16 XC556Y T1³/₄, (Yellow)....\$.16

IC Sockets

| Low Profile | Wire Wrap (Gold) Level #2 |
|-----------------|---------------------------|
| 8LP.....\$.11 | 8WW.....\$.49 |
| 14LP.....\$.12 | 14WW.....\$.69 |
| 16LP.....\$.13 | 16WW.....\$.79 |
| 24LP.....\$.19 | 24WW.....\$ 1.15 |
| 28LP.....\$.22 | 28WW.....\$ 1.39 |
| 40LP.....\$.28 | 40WW.....\$ 1.89 |

Soldertail Standard & Header Plug Sockets Also Available

• Customer Service • Technical Assistance • Credit Department • All Other Inquiries • (415) 592-8097 • 7AM - 4PM P.S.T.

CIRCLE 114 ON FREE INFORMATION CARD

www.americanradiohistory.com

We Have **QUALITY PARTS** • We Have **DISCOUNT PRICES** • We **SHIP FAST**

ALL ELECTRONICS CORP.

Highest Quality Metal C-60 Cassettes (Erased)

Premium quality metal tape in C-60 cassettes (30 min. per side). One of the finest "brand-name" tapes on the market, in durable, clear plastic transport mechanisms. Recorded and bulk erased, the record-protect tabs have been removed and therefore, need to be taped over to re-record. Audiophiles will appreciate the wide dynamic range of this tape. If your cassette deck has a "metal" setting you will hear the difference. A real bargain!
CAT# C-60M \$1.25 each • 10 for \$10.00

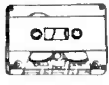

TOUCH DIMMER

The "brain" part of the "LITE TOUCH" touch dimmer, when connected to any lamp, will turn it on and off and change the brightness level when any metal part is touched. We don't have the wiring harness that originally connected this to the lamp, but we can provide a simple hook-up diagram and instruction sheet. The solid-state circuitry is contained in a thermo-plastic box 1.91" X 3.11" X 0.835".
CAT# DMR-1 \$3.50 each

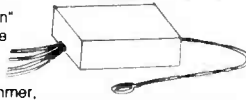

INFRARED SECURITY LIGHT (AS-IS)

Elektriko # SIL-101 - Experiment with infrared sensors with these outdoor security lights. Contain lots of interesting components, and IR detector, photoresistor, relay, transformer, IC's, voltage regulator, capacitors, trim pots and other goodies. Returned to the distributor for variety of reasons, we've found that most of them work to some extent. We don't want to test them and would prefer to sell them "as-is" at a greatly reduced price. Mounts to any standard electrical junction box. Infrared sensor detects movement up to 65 feet and turns on lights. Sensor can be adjusted for sensitivity and duration of lighting. The position of the sockets and the infrared sensor can be easily adjusted. Will handle two 150 watt PAR 38 lamps. Suitable for wet locations. Bulbs not included.
CAT# IL-101 \$7.50 each

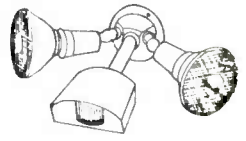

SWITCHES

Dip P.C. Pushbutton

ITT Schadow Digitast Series SE S.P.D.T. momentary pushbutton. Mounts in 14 pin DIP configuration. Designed for low current switching applications. Gray keycap is 0.68" X 0.67".
CAT# PB-2B \$1.00 each
 10 for \$9.50 • 100 for \$85.00



Pushbutton Switch
 SMK Manufacturing 0.47" square black pushbutton. SPST normally open. 4 p.c. pins for mounting. Ideal for low current switching applications. **CAT# PB-29**
 5 for \$1.00 • 100 for \$15.00



Rotary BCD Switch

ECCO # 2310-02G BCD 10 position rotary switch. DIP configuration fits in standard 8 pin I.C. socket. Right angle style. Screwdriver actuation. 0.42" cube.
CAT# RDIP-2 \$1.75 each
 10 for \$16.00 • 100 for \$145.00



Miniature Toggles

Rated: 3 amps @ 120 Vac
S.P.D.T. (ON-ON) P.C. mount
CAT# MTS-4PC \$1.00 each
 10 for \$9.00 • 100 for \$80.00
S.P.D.T. (ON-ON) solder lugs
CAT# MTS-4 \$1.35 each
 10 for \$12.50 • 100 for \$110.00
D.P.D.T. (ON-ON) solder lugs
CAT# MTS-8 \$1.75 ea. 10 for \$15.00
D.P.D.T. (ON-ON) P.C. mount
CAT# MTS-8PC \$2.00 ea. 10 for \$17.50



TELEPHONE KEYPAD

12 button telephone keypad. Ivory finish. 2.83" x 2.2" x 0.58" thick. Matrix encoded. Ideal for telephone or security keypad.
CAT# KPT-1 \$1.00 each • 10 for \$9.00



OPTO-SENSOR

TRW/Optron # OPB5447-2 IR emitter/sensor pair in Rectangular package with 28" color coded leads.
CAT# OSR-4 2 for \$1.00



PHOTOFLASH CAPACITOR

Rubicon CE 210 Mfd 330 Volt photoflash capacitor. 0.79" dia. X 1.1" high. These are new capacitors that have been prepped with 1.4" black and red wire leads soldered to the terminals. **CAT# PPC-210**
 \$1.25 each • 10 for \$11.00
 100 for \$100.00
 Large quantities available. Call for pricing.



RECHARGEABLE BATTERIES

6 Volt 1 Amp/Hour
 Japan Storage Battery Co. Portalac # PEG6V1 6 Volt 1 Ah rechargeable sealed lead-acid (gell cell). 2" X 1.635" X 2" ht. Batteries are prepped with 5" black and red leads terminated with 2 pin connector.
CAT# GC-61 \$4.75 each
 10 for \$42.50



Nickel-Cad

AAA SIZE \$1.50 each
 1.2 volts 180 mAh
CAT# NCB-AAA
AA SIZE \$2.00 each
 1.25 volts 500 mAh
CAT# NCB-AA
AA SIZE \$2.20 each
 WITH SOLDER TABS
CAT# NCB-SAA
C SIZE \$4.25 each
 1.2 volts 1200 mAh
CAT# NCB-C
D SIZE \$4.50 each
 1.2 volts 1200 mAh
CAT# NCB-D



HALL EFFECT SENSOR

Microswitch #SS41 Tiny, solid state switch reacts instantly to proximity of magnetic field. Operates at extremely high speeds, up to 100 khz. Case size: 0.12" X 0.17" X 0.06" thick. 4.5 Vdc to 24 Vdc supply voltage. 10 ma. sink type digital output. Operating gauss - 15 to 40. P.C. leads.
CAT# HESW-2 75¢ each • 10 for \$6.50
 100 for \$60.00 • 1000 for \$500.00



3 1/2" DISKETTES

Quality, double-sided 3 1/2" diskettes. These diskettes were recorded, but never used. Flip the write-protect tab to off position and use for your own data storage at a fraction of the cost of new diskettes.
CAT# DTS-1 \$1.00 each • 10 for \$9.00



AUDIO SLIDE POT

Dual 1K audio. 3 1/2" long, 2 1/2" slide
CAT# ASP-1KD
 Reduced to 50¢ each
 100 for \$40.00



I.E.C. POWER CORD

6 foot BLACK, SPH-386 jack to 3 prong molded A.C. plug. Fits most computers, computer terminals and test equipment.
CAT# LCAC-C6 \$3.00 each



FLASH ASSEMBLY

New compact flash assembly from a U.S. manufacturer of cameras. Operates on 3 Vdc and measures 2 1/2" x 1 1/4". Ideal for use as a strobe, warning light or attention getter. Includes hook-up diagram. **CAT# FSH-1 \$3.75 each**
 10 for \$35.00 • 100 for \$325.00



P.C. RELAYS

The following relays all have p.c. pins for both input and output as well as quick-connect terminals on the output. 1.5" X 1.05" X 1.08". UL & CSA listed.



12 Vdc, SPDT
 Potter & Brumfield # T91R5D22-12-02
 12 Vdc, 155 ohm coil. Normally open contacts rated 20 amps. Normally closed contacts rated 10 amps.
CAT# RLY-31 \$2.50 each
 10 for \$22.50

12 Vdc, SPST N. O.
 Potter & Brumfield # T91R5D22-12-01
 12 Vdc, 155 ohm coil, S.P.S.T. normally open contacts rated 30 amps.
CAT# RLY-32 \$2.00 each
 10 for \$18.00

L.E.D.'s

Standard JUMBO
 Diffused T 1-3/4 size (5 mm)

RED **CAT# LED-1**
 10 for \$1.50 • 100 for \$13.00

GREEN **CAT# LED-2**
 10 for \$2.00 • 100 for \$17.00

YELLOW **CAT# LED-3**
 10 for \$2.00 • 100 for \$17.00

FLASHING LED
 W/ built in flashing circuit 5 volt operation. T 1-3/4 (5mm)

RED \$1.00 each
CAT# LED-4 10 for \$9.50

GREEN \$1.00 each
CAT# LED-4G 10 for \$9.50

YELLOW \$1.00 each
CAT# LED-4Y 10 for \$9.50

LED HOLDER
 Two piece holder.
CAT# HLED 10 for 65¢

KITS

L.E.D. FLASHER KIT

Two L.E.D.'s flash in unison when a 9 volt battery is attached. This kit includes a p.c. board, all the parts and instructions to make a simple flasher circuit. A quick and easy project for anyone with basic soldering skills.
CAT# LEDKIT \$1.75 per kit



L.E.D. CHASER KIT

Build this variable speed led chaser. 10 leds flash sequentially at whatever speed you set them for. Easy to build kit includes pc board, parts and instructions. Ideal for special lighting effects, costumes, etc. Operates on 3 to 9 volts. PC board is 5" X 2.25". A great one hour project.
CAT# AEC \$6.50 each

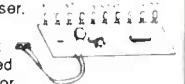

STEPPING MOTOR CONTROLLER KIT

Learn about stepping motors while building this simple circuit. Includes circuit board, stepping motor and all parts except 12 Vdc power supply.
CAT# SMKIT \$18.00 each



METRONOME KIT

This simple device can be set to click from 20 to 1,000 beats per minute. Easy to build, includes circuit board, all components and instructions. Operates on a 9 volt battery (not included).
CAT# METRO \$3.75 each



PHOTO RESISTOR

1,000 ohms bright light. 16K ohms dark. 0.182" dia. X .08" high. 0.18" long leads.
CAT# PRE-7 2 for \$1.00
 100 for \$45.00 • 1000 for \$400.00



ORDER TOLL FREE 1-800-826-5432

FAX (818) 781-2653 • INFORMATION (818) 904-0524

Call Or Write For Our Free 64 Page Catalog

Outside the U.S.A. send \$2.00 postage for a catalog.

Minimum Order \$10.00 • All Orders Can Be Charged To Visa, Mastercard Or Discovercard • Checks and Money Orders Accepted By Mail • California, Add Sales Tax • Shipping And Handling \$3.50 for the 48 Continental United States • All Others Including Alaska, Hawaii, P.R. And Canada Must Pay Full Shipping • Quantities Limited • No C.O.D. • Prices Subject to change without notice.



MAIL ORDERS TO: ALL ELECTRONICS CORP • P.O. BOX 567 • VAN NUYS, CA 91408

CIRCLE 107 ON FREE INFORMATION CARD

www.americanradiohistory.com

GOLDSTAR – 20 MHZ AND 40 MHZ DUAL TRACE OSCILLOSCOPES

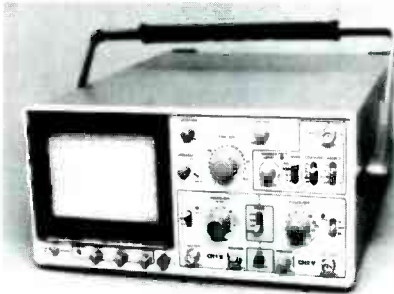

S7020A

2 Year Manufacturer's Warranty

•20Mhz Dual-Trace Oscilloscope

The Model S7020A is a utility oscilloscope that features scale illumination and beam rotation capabilities, plus a 6" rectangular CRT with an internal graticule. The acceleration voltage is regulated to ensure accurate measurements. This model offers 5mV/div (20Mhz), 1mV/div (7Mhz), and a maximum sweep rate of 100 ns/div (x10 MAG).

•40Mhz Dual-Trace Oscilloscope

The Model S7040A is a standard oscilloscope that features delayed sweep triggered function, signal delay lines, scale illumination and beam rotation capabilities, plus a high-brightness, aluminized 6-inch rectangular CRT with an internal graticule. The acceleration voltage is regulated to ensure accurate measurements. This model offers 5mV/div (40Mhz), 1mV/div (7Mhz), and a maximum sweep rate of 100 ns/div (x10 MAG).

| Order # | Price | Description | Shipping Weight |
|---------|--------|------------------------------------|-----------------|
| S7020A | 399.95 | 20 Mhz Dual Trace Oscilloscope | 20 lbs. |
| S7040A | 699.95 | 40 Mhz Dual Trace w/ Delayed Sweep | 22 lbs. |
| SP100 | 49.95 | 100 Mhz Probe Kit (Pair) | 12 oz. |
| SP101 | 34.95 | 50 Mhz Probe Kit (Pair) | 12 oz. |

S7020A SPECIFICATIONS

| •CRT | Large 6" screen with internal graticule, 8x10 div (1 div=10 mm) with 0,10,90 and 100% markers | | | | | | | | | |
|--------------------------------------|---|-----------|---------------|-----|------------|--------|-------|------------|--------|-------|
| Graticule | Approximately 2kV | | | | | | | | | |
| Acceleration potential | Sensitivity: At least 5 Vp-p | | | | | | | | | |
| Z-axis input | Polarity: Positive-going input decreases intensity | | | | | | | | | |
| | Usable frequency range: DC to 2Mhz | | | | | | | | | |
| | Maximum input voltage: 30V (DC+AC peak) | | | | | | | | | |
| | Input impedance: 47KΩ (typ) | | | | | | | | | |
| •Vertical Deflection System | | | | | | | | | | |
| Sensitivity and accuracy | 5mV/div to 5V/div ±3% 10 calibrated steps 1mV/div to 1V/div ±5% (when using x5 magnifier) Uncalibrated continuous variable control between steps at least 1:2.5 with uncalibrated | | | | | | | | | |
| Bandwidth | DC to 20Mhz (-3dB) When using x5 magnifier: DC to 7Mhz (-3dB) | | | | | | | | | |
| Rise time | Approximately 17.5ns When using x5 magnifier: Approx. 50ns | | | | | | | | | |
| Max. input voltage | 300V (DC+AC peak) or 500Vp-p AC at 1kHz | | | | | | | | | |
| Input coupling | AC, GND, DC | | | | | | | | | |
| Input impedance | 1MΩ approximately 30±5pF | | | | | | | | | |
| Display mode | CH1, CH2, ALT, CHOP, ADD | | | | | | | | | |
| Polarity invert | CH2 only | | | | | | | | | |
| Dynamic range | 8 divisions or more | | | | | | | | | |
| •X-Y Operation | | | | | | | | | | |
| input | CH1: X-axis CH2: Y-axis | | | | | | | | | |
| Bandwidth | DC to 500kHz (-3dB) | | | | | | | | | |
| Sensitivity | 5mV/div to 5V/div (1mV/div to 1V/div when using x5 magnifier) | | | | | | | | | |
| Phase difference | less than 3° at 20kHz | | | | | | | | | |
| •Horizontal Deflection System | | | | | | | | | | |
| Time base (A) | 0.2us/div to 0.2s/div ±3% Additional error for magnifier ±2% Uncalibrated continuous control between steps 1:2.5 | | | | | | | | | |
| Maximum sweep rate | 100ns/div (20ns/div and 50ns/div are uncalibrated) | | | | | | | | | |
| •Trigger System | | | | | | | | | | |
| Trigger mode | AUTO, NORM, TV-V, TV-H | | | | | | | | | |
| Trigger source | INT (CH1, CH2), LINE, EXT | | | | | | | | | |
| Trigger coupling | AC, HF REJ, LF REJ, DC | | | | | | | | | |
| Trigger sensitivity | <table border="1"> <thead> <tr> <th>Frequency</th> <th>INT (CH1,CH2)</th> <th>EXT</th> </tr> </thead> <tbody> <tr> <td>DC to 2Mhz</td> <td>0.5div</td> <td>200mV</td> </tr> <tr> <td>2 to 20Mhz</td> <td>1.5div</td> <td>800mV</td> </tr> </tbody> </table> | Frequency | INT (CH1,CH2) | EXT | DC to 2Mhz | 0.5div | 200mV | 2 to 20Mhz | 1.5div | 800mV |
| Frequency | INT (CH1,CH2) | EXT | | | | | | | | |
| DC to 2Mhz | 0.5div | 200mV | | | | | | | | |
| 2 to 20Mhz | 1.5div | 800mV | | | | | | | | |
| TV trigger sensitivity | INT: Sync pulse more than 1div EXT: Sync pulse more than 1 Vp-p | | | | | | | | | |
| EXT trigger input | 30pF (Max. input voltage: 300V [DC to AC peak] at 1kHz) | | | | | | | | | |

SOLDERLESS PROTOTYPING BOARDS

FEATURES

- Color coordinates for easy recognition
- Insertion wire: 20-29 AWG (0.3 - 0.8 mm)
- Over 10,000 insertion cycles
- Accepts all standard components

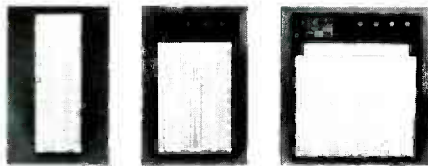

| EasyTech Order # | Price 1-9 | Price 10+ | Dimensions (in.) L x W x H | Dist. Strips | Dist. Points | Term. Strips | Term. Points | Binding Posts |
|------------------|-----------|-----------|----------------------------|--------------|--------------|--------------|--------------|---------------|
| SB200 | 2.99 | 2.49 | 6.5 x .37 x .4 | 2 | 100 x 2 | 0 | 0 | 0 |
| SB400 | 4.89 | 4.39 | 3.3 x 2.2 x .4 | 2 | 100 | 1 | 300 | 0 |
| SB630 | 5.49 | 4.99 | 6.5 x 1.4 x .4 | 0 | 0 | 1 | 630 | 0 |
| SB830 | 6.49 | 5.99 | 6.5 x 2.2 x .4 | 2 | 200 | 1 | 630 | 0 |
| SB1360 | 12.49 | 11.99 | 8.5 x 3.9 x 1.2 | 1 | 100 | 2 | 1,260 | 2 |
| SB1660 | 17.49 | 16.99 | 8.5 x 5.1 x 1.2 | 4 | 400 | 2 | 1,260 | 3 |
| SB2390 | 22.49 | 21.99 | 9.1 x 6.9 x 1.2 | 5 | 500 | 3 | 1,890 | 4 |
| SB3220 | 31.49 | 30.99 | 9.5 x 8.3 x 1.2 | 7 | 700 | 4 | 2,520 | 4 |

MATH COPROCESSORS

Super Savings Special!!

| Order # | Price | Description | Pins |
|-----------|--------|--|-------|
| 80C287A12 | 149.95 | Intel 12Mhz For 80286 CPU Based Laptops | 40 |
| 80387-16 | 259.95 | Intel 16Mhz | PGA68 |
| 83D87-16 | 279.95 | For 80386 CPU Based Computers Cyrix 16Mhz | PGA68 |
| 83D87-33 | 489.95 | For 80386 CPU Based Computers Cyrix 33Mhz | PGA68 |



2917 Bayview Drive • Fremont, CA 94538

Order Direct: 1-800-582-4044

Fax Direct: 1-800-582-1255

Monday-Friday, 7am - 5pm (PST)/10am-8pm (EST)



COD-No personal checks, US funds (\$5.00 charge)

USPS UPS Airborne Express

Add 5% of total for ground shipping charges (\$3.00 min.)

*California residents, add appropriate sales tax.

*12 month warranty on all EasyTech products.

*30 day money back guarantee.

*We reserve the right to substitute manufacturers.

*Prices subject to change without notice.

Extensive range of parts & components in stock

Call to reserve your free copy of our new 1991 catalog due in late July

CIRCLE 179 ON FREE INFORMATION CARD



Your Ticket To SUCCESS

Over 28,000 technicians have gained admittance worldwide as certified professionals. Let your ticket start opening doors for you.

ISCET offers Journeyman certification in Consumer Electronics, Industrial, Medical, Communications, Radar, Computer and Video. For more information, contact the International Society of Certified Electronics Technicians, 2708 West Berry Street, Fort Worth, TX 76109; (817) 921-9101.

Name _____
 Address _____
 City _____
 State _____ Zip _____

Send material about ISCET and becoming certified.

Send one "Study Guide for the Associate Level CET Test." Enclosed is \$10 (inc. postage).

AMAZING SCIENTIFIC & ELECTRONIC PRODUCTS

LASERS AND SCIENTIFIC DEVICES

| | | |
|--------|---|----------|
| VRL2K | 3mw Vis Red Laser Diode System Kit | \$159.50 |
| LLIS1K | Laser Beam "Bounce" Listener Kit | \$199.50 |
| LHC2K | Visible Simulated 3 Color Laser Kit | \$44.50 |
| LC7 | 40 Watt Burning Cutting Laser Plans | \$20.00 |
| RUB4 | Hi Powered Pulsed Drilling Laser Plans | \$20.00 |
| LGU40 | 1 to 2mw HeNe Vis Red Laser Gun Assembled | \$199.00 |
| LLS1 | Laser Lite Show - 3 Methods Plans | \$20.00 |
| SD5K | See in the Dark Kit | \$299.50 |
| EML1K | Electromagnetic Coil Gun Kit | \$69.50 |
| MCP1 | Hi Velocity Coil Gun Plans | \$15.00 |
| LEV1 | Levitating Device Plans | \$10.00 |
| EH1 | Electronic Hypnotism Techniques Plans | \$10.00 |

HIGH VOLTAGE AND PLASMA DISPLAY DEVICES

| | | |
|-------|---|----------|
| HVM7K | 75,000 Volt DC Variable Output Lab Source Kit | \$149.50 |
| IQG3K | Ion Ray Gun Kit, project energy without wires | \$69.50 |
| NIG9K | 12V/115 VAC Hi Out Neg Ion Generator Kit | \$34.50 |
| EMA1K | Telekinetic Enhancer/Electric Man Assembled | \$99.50 |
| LG5K | Lightning Display Globe Kit | \$54.50 |
| BTC1K | Worlds Smallest Tesla Coil Kit | \$49.50 |
| BTC3K | 250KV Table Top Tesla Coil Kit | \$249.50 |
| BTC5 | 1.5 Million Volts Tesla Coil Plans | \$20.00 |
| JL3 | Jacobs Ladder - 3 Models Plans | \$15.00 |
| GRA1 | Anti Gravity Generator Plans | \$10.00 |
| PFS20 | Plasma Fire Saber Assembled | \$69.50 |
| DPL20 | Dancing Plasma to Music and Sounds Assembled | \$79.50 |

SECURITY AND PROTECTION DEVICES

| | | |
|--------|--|----------|
| ITM10 | 100,000 Volt Intimidator up to 20' Assembled | \$129.50 |
| IPG70 | Invisible Pain Field Blast Wave Gen Assembled | \$74.50 |
| PSP4K | Phasor Sonic Blast Wave Pistol Kit | \$59.50 |
| LIS10 | Infinitely Xmfr, Listen in Via Phone Assembled | \$199.50 |
| TAT30 | Automatic Tel Recording Device Assembled | \$24.50 |
| VWPM7K | 3 Mi. FM Auto Tel Transmitter Kit | \$49.50 |
| FHV1K | 3 Mi. FM Voice Transmitter Kit | \$39.50 |
| HOD1K | Homing/Tracking Beeper Transmitter Kit | \$49.50 |

EASY ORDERING PROCEDURE TOLL FREE 1-800-221-1705
 or 24 HRS ON 1-603-673-4730 or FAX IT TO 1-603-672-5406

VISA, MC, CHECK, MO IN US FUNDS. INCLUDE 10% SHIPPING. ORDERS \$100.00 & UP ONLY ADD \$10.00. CATALOG \$1.00 OR FREE WITH ORDER.

INFORMATION UNLIMITED
 P.O. BOX 716, DEPT. R3, AMHERST, NH 03031

ADVERTISING INDEX

RADIO-ELECTRONICS does not assume any responsibility for errors that may appear in the index below.

| Free Information Number | Page | | Page | | |
|-------------------------|----------------------------|--------|-----------------|----------------------|--------|
| 108 | AMC Sales | 30 | — Star Circuits | 25 | |
| 75 | Ace Products | 32 | 188 | TECI | 78 |
| 107 | All Electronics | 94 | — | TAB Books | 23 |
| — | Amazing Concepts | 96 | 92 | Tektronix | 13 |
| 109 | C & S Sales | 7 | — | The SPEC-COM Journal | 76 |
| — | CIE | 11, 17 | 178 | Unicorn | 90 |
| — | Cable Ready Company | 85 | 186 | U.S. Cable | 16 |
| 189 | Cable Warehouse | 60 | 176, 192 | Viejo Publications | 60, 76 |
| 50 | Caig Laboratories | 25 | 177 | WPT Publications | 78 |
| 183 | Cheneko Products | 32 | — | Wholesale Cable | 88 |
| — | Command Productions | 76 | 195 | Worldwide Cable | 86 |
| 196 | Communications Specialists | 78 | 194 | Xandi Electronics | 32 |
| 55 | Contact East | 32 | | | |
| 58 | Cook's Institute | 30 | | | |
| 127 | Deco Industries | 32 | | | |
| 193 | Direct Sound Corporation | 60 | | | |
| 179 | EasyTech | 95 | | | |
| 180 | Electronic Goldmine | 87 | | | |
| — | Electronics Book Club | 18 | | | |
| 121 | Fluke Manufacturing | CV2 | | | |
| — | Global Cable Network | 84 | | | |
| 190 | Global Specialties | 3 | | | |
| — | Grantham College | 14 | | | |
| — | ISCET | 96 | | | |
| 114 | Jameco | 92, 93 | | | |
| 104 | Jan Crystals | 30 | | | |
| 115 | Jensen Tools | 32 | | | |
| 191 | Kelvin | 91 | | | |
| 187 | Lake Sylvan Sales, Inc. | 89 | | | |
| 53 | MD Electronics | 86 | | | |
| 93 | Mark V. Electronics | 87 | | | |
| — | NPEC | 12 | | | |
| — | NRI Schools | 29, 75 | | | |
| 184 | Optoelectronics | CV3 | | | |
| 56 | Parts Express | 89 | | | |
| — | Perfect Cable | 85 | | | |
| — | Phillips Tech | 85 | | | |
| 181 | R.L. Drake Co. | 15 | | | |
| 78 | Radio Shack | 5 | | | |
| 185 | SCO Electronics | 16 | | | |
| 182 | Scencore | CV4 | | | |

ADVERTISING SALES OFFICE

Gernsback Publications, Inc.
 500-B Bi-County Blvd.
 Farmingdale, NY 11735
 1-(516) 293-3000
 President: Larry Steckler

For Advertising ONLY
 516-293-3000
 Fax 1-516-293-3115
 Larry Steckler
 publisher

Christina Estrada
 assistant to the President
Arlene Fishman
 advertising director
Denise Haven
 advertising assistant
Kelly McQuade
 credit manager

Subscriber Customer Service
 1-800-288-0652

Order Entry for New Subscribers
 1-800-999-7139
 7:00 AM - 6:00 PM M-F MST

SALES OFFICES

EAST/SOUTHEAST

Stanley Levitan, Eastern Sales Manager
 Radio-Electronics
 259-23 57th Avenue
 Little Neck, NY 11362
 1-718-428-6037, 1-516-293-3000
 Fax 1-718-225-8594

MIDWEST/Texas/Arkansas/Okla.

Ralph Bergen, Midwest Sales Manager
 Radio-Electronics
 540 Frontage Road—Suite 204
 Northfield, IL 60093
 1-708-446-1444
 Fax 1-708-559-0562

PACIFIC COAST/Mountain States

Marvin Green, Pacific Sales Manager
 Radio-Electronics
 5430 Van Nuys Blvd, Suite 316
 Van Nuys, CA 91401
 1-818-986-2001
 Fax 1-818-986-2009

RE Shopper

Joe Shere, National Representative
 P.O. Box 169
 Idyllwild, CA 92349
 1-714-659-9743
 Fax 1-714-659-2469

OPTOELECTRONICS

\$99.
Introductory Price

1MHz - 2.4GHz

BEST SENSITIVITY BEST RANGE HOLD SWITCH

The Original Handi-Counter™
Imitated but Never Duplicated



Actual Size
Made in the USA

OPTOELECTRONICS brings you the latest in a long line of quality LED Handi-Counters™ - **The New 2300**. The 2300 has inherited the outstanding features of the 1200H, 1300H, 2400H & 1300HA.

No other counter can match this family history. **Additional new features include:**

- **Dual MMIC Amplifiers** for maximum possible sensitivity. (<1mv 150MHz <5mv 850MHz <25mv 2GHz.)
- **Continuous Range.** No cumbersome range switch.
- **Hi-Tech Painted Finish.** More rugged than anodized cases.
- **600 mA Hr. Batteries.** Not the cheapest but the best!
- **Display Saving Power Switch.** Avoids Premature LED Burn out. (Leading cause of counter failure.)
- **17 years of quality and dependability to back our products.**

\$199. New low price on full range model

- Model 2300** 1MHz - 2.4GHz Frequency Counter..... **\$ 99.**
NiCad 23 Custom internal NiCad Pack (installed)..... **\$ 20.**
AC90 110VAC - 9VDC Charger/Adapter..... **\$ 9.**
Complete Package Model 2300, Internal NiCads & A/C Adapter..... **\$128.**



| Model | 8030 | 3000 | 2600H | 2600HA | 2210A | 2300 |
|------------------------------|-------------------------------------|--------------------------------------|--------------------------------|--------------|-------------|-------------|
| Function | Freq, Period Ratio, Interval | Freq, Period Ratio Interval | Frequency | Frequency | Frequency | Frequency |
| Range | 10Hz-2.6GHz | 10Hz-2.6GHz | 1MHz-2.6GHz | 1MHz-2.6GHz | 1MHz-2.4GHz | 1MHz-2.4GHz |
| Display | 10 Digit LCD w/Func on Annunciators | 10 Digit LCD w/Function Annunciators | 10 Digit LCD | 10 Digit LCD | 8 Digit LED | 8 Digit LED |
| RF Signal Strength Indicator | 16 Segment Adjustable Bargraph | 16 Segment Adjustable Bargraph | 16 Segment Adjustable Bargraph | . | . | . |
| Price | \$579. | \$375. | \$325. | \$225. | \$199. | \$99. |

Sensitivity: <1 to <10mV typical. Time Base: ± 1 ppm.; ± 2ppm add \$100. - LCD Models. NiCads & AC charger/adapter included except for 2300. *For 2300, NiCad install \$20. & AC charger/adapter, \$9. Carry case and a full line of probes and antennas are available. One year parts & labor warranty on all products.

FACTORY DIRECT ORDER LINE

1-800-327-5912

FL(305)771-2050 • FAX(305)771-2052

5821 NE 14th Avenue • Fort Lauderdale, FL 33334
5% Shipping Handling, (Maximum \$10) U.S. & Canada 15% outside continental U.S.A.
Visa and MasterCard accepted.

Latest Technology 10 digit LCD Hand-Counters™



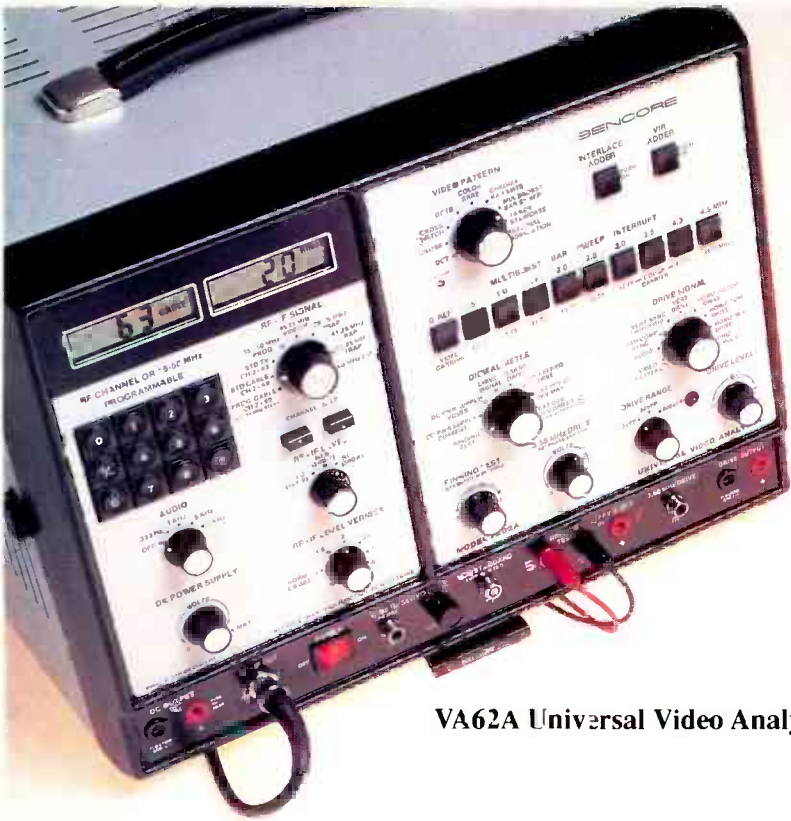

VA62A Universal Video Analyzer

*Isolate These And Other
Major Components
In All TVs And VCRs—
Guaranteed Or Your Money Back!*

Plus, Cut Your Video Troubleshooting Time By 54%* With The Patented VA62A Universal Video Analyzer!

Identify tuner problems with the only integrated all-channel, VHF, UHF, and cable RF generator. Standard TV, standard cable (2-99), and exclusive programmable cable channels eliminate the question "Is it the TV or is it the cable?"

Pinpoint IF troubles with modulated troubleshooting signals and exclusive programmable IF generator. How do you presently identify if the suspected defect is in the AGC, IF/Detector IC, or caused by the tuner? Wouldn't you like to know exactly where the defect is before you order the part or pull the tuner. With the VA62A you will!

Exclusive video patterns completely performance test TVs, VCRs, and monitors — without removing the cover. Is there a picture, is it locked in, is the bandwidth correct, is the brightness and contrast correct, and is the color tint and saturation correct? You'll know in less than 60 seconds using the VA62A's exclusive video patterns.

Find defective stages, without disconnecting parts, with exclusive phase-locked drive signals. "Swamp out" the suspect signal and replace it with a known-good signal. You'll isolate the problem to a bad stage in minutes, guaranteed.

Test yokes and flybacks with the patented "Ringer". Most shops are forced to substitute yokes and flybacks instead of



analyzing circuits. The VA62A's patented "Ringer" and exclusive flyback drive tests allow you to completely analyze all yokes, flybacks, and IHVTs before you order a new one.

Measure signal levels with a fully autoranged PPV and DCV digital meter. The VA62A's built-in meter shows when you are driving into a shorted circuit and prevents you from overdriving critical stages. Plus, measure bias voltages and signal levels throughout the entire TV and VCR.

It's obsolete proof: update for new technology with exclusive phase-locked accessories. We'll provide new companion units as the manufacturers announce new formats, test patterns, etc. This makes your VA62A a protected investment.

* Based on a nationwide survey of users who reported an average time savings of 54% compared to their previous test equipment.

**For More Details Call 1-800-SENCORE ext. 612
(736-2673)**

CIRCLE 182 ON FREE INFORMATION CARD